



# 2024 FİYAT LİSTESİ

[www.akisplastik.com.tr](http://www.akisplastik.com.tr)



ELECTRICAL MATERIALS

# AKIS

---

P L A S T I C



# HAKKIMIZDA - ABOUT US

## Hakkımızda

Fabrikamız 2012 yılında İstanbul'da kurulmuştur, 10.000 mt2 kapalı alanda pvc kablo kanalı, abs ve pc elektrik panoları, çelik ve izoleli çelik spiral, aspiratör vb. elektrik malzemeleri üretimi yapmaktadır.

Yıllık 24.000.000 mt kablo kanalı, 480.000 adet elektrik panosu, 3.000.000 çelik spiral ve 250.000 adet aspiratör üretim kapasitesi ile kaliteden hiçbir şekilde ödün vermeden siz değerli iş ortaklarımızla daha büyük hedeflere ilerlemektedir. Otuz yıllık bilgi birikimi ve deneyimlerimize güvenerek siz değerli müşterilerimize hizmet vermekten gurur duyuyoruz. Globalleşen dünyada bir adım öne çıkmanın yolu istikrarlı çalışmak daha kaliteli ürün ve hizmet vermektir. Geçmekte olduğunun bilincindeyiz. Daimi sloganımız ve nihai hedefimiz siz değerli müşterilerimizin memnuniyetidir.

## About Us

Our company was built in 2012 in Istanbul. Our factory is with an area of 10.000 m2 in the production cable trunkings products, Abs and Pc panel boards, Steel and Insulated steel spiral, Aspirator and etc. electrical materials.

With an annual production capacity of 24,000,000 mt of cable trunking, 480,000 pieces of electrical panels, 3,000,000 mt steel spirals and 250,000 aspirators, it is advancing towards greater goals with you, our valuable business partners, without compromising on quality. We are proud to serve our valued customers, trusting our thirty years of knowledge and experience. We are aware that the way to stand out in the globalizing world is to work consistently and to provide better quality products and services. Our motto and our ultimate goal is the satisfaction of our customers.

تأسس مصنعنا في عام 2012 في اسطنبول

حلزونات فولاذية وفولاذية معزولة ، شفاطة وما إلى ذلك في منطقة مغلقة تبلغ 10.000 متر مربع. تصنع المعدات ، PC و ABS لوحات كهربائية ، PVC مجاري كابل الكهربائية.

بفضل طاقتها الإنتاجية السنوية البالغة 24.000.000 طن متري من مجاري الكابلات ، و 480.000 لوحة كهربائية ، و 3.000.000 من اللوالب الفولاذية و 250.000 شفاط ، فإنها تتقدم نحو أهداف أكبر مع شركائنا التجاريين القيمين ، دون المساومة على الجودة. نفخر بخدمة عملائنا الكرام ، من خلال الاعتماد على ثلاثين عامًا من المعرفة والخبرة. نحن ندرك أن السبيل للمضي قدمًا في عالم العولمة هو العمل باستمرار وتقديم منتجات وخدمات ذات جودة أفضل. شعارنا الدائم وهدفنا النهائي هو إرضاء عملائنا الكرام.

## İÇERİK - INDEX

KAPALI TİP KABLO KANALLARI - CLOSED TYPE CABLE TRUNKINGS	01 - 08
İÇTEN KAPAKLI KABLO KANALI VE AKSESUARLARI - INSIDE COVER CABLE TRUNKING AND ACCESSORIES	09
MONTAJ TAMAMLAMA AKSESUARLARI - ASSEMBLY ACCESSORIES	10
YAPIŞKAN BANTLI KABLO KANALLARI - SELF ADHESIVE CABLE TRUNKINGS	11
ZEMİN ÜSTÜ (BALIK SIRTII) PVC KABLO KANALLARI GRİ - OVERFLOOR PVC CABLE TRUNKINGS GREY	12
DELİKLİ (PANO TİPİ) PVC KABLO KANALLARI GRİ - PVC SLOTTED CABLE TRUNKINGS GREY	13 - 16
ASPIRATÖR - ASPIRATORS	17
ABS PANO - ABS BOARD	18 - 21
SUSTALAR VE KABLO MAKARASI - SPRINGS AND CABLE REEL	22
BORULAR - CONDUITS	23 - 28
KABLO KELEPÇESİ VE KABLO BAĞLARI - CABLE CLAMP AND CABLE TIES	29
SERTİFİKALAR - CERTIFICATES	30 - 31



**Mekanik Darbelere dayanıklı.**  
Resistance to mechanical  
shock hits 2 Joule



**Topraklama gerekmez.**  
No need for grounding



Alev aldığıında kendiliğinden sönebilen katkı maddeli PVC malzeme (UL94V0 M1).  
Self extinguishing PVC fire reaction (UL94V0 M1)

## Kapalı tip kablo kanallarımızın teknik özellikleri

Technical specifications for closed type cable trunkings

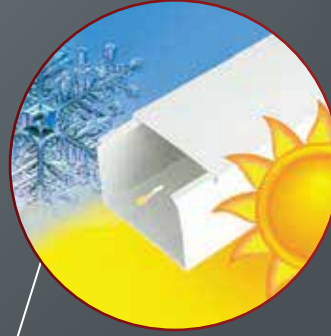

Ultraviyole ışıklara dayanıklı (UV).  
Resistance to ultraviolet lights (UV)



Boyanabilir.  
Paintable



İstenilen boyutta kesilebilir.  
Cut down to required size

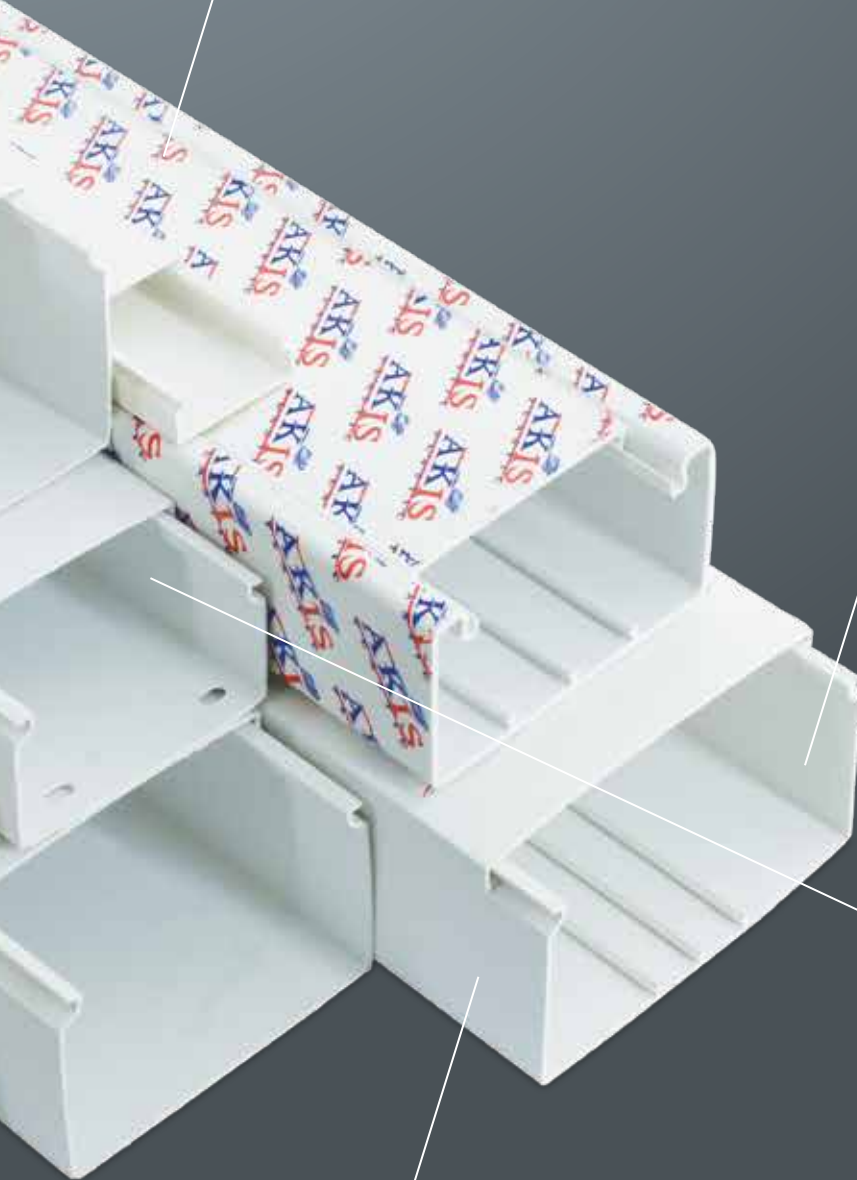



**12 x 12**

9,30 ₺

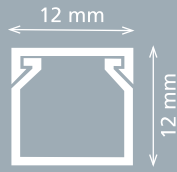

Ürün Kodu - Product Code

**APSK - 12012 Kutulu**

Kutu - Box

Paket / Metre - Package / Meter

320 mt



**15 x 10**

10,15 ₺

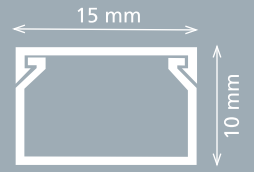

Ürün Kodu - Product Code

**APSK - 15010 Kutulu**

Kutu - Box

Paket / Metre - Package / Meter

300 mt



**16 x 16**

11,75 ₺

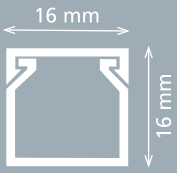

Ürün Kodu - Product Code

**APSK - 16016 Kutulu**

Kutu - Box

Paket / Metre - Package / Meter

266 mt



**20 x 10**

12,35 ₺

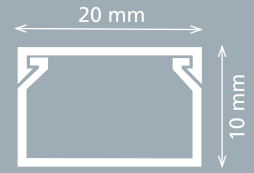

Ürün Kodu - Product Code

**APSK - 20010 Kutulu**

Kutu - Box

Paket / Metre - Package / Meter

240 mt



**25 x 16**

17,60 ₺

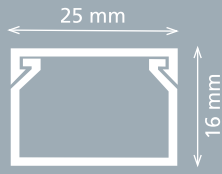

Ürün Kodu - Product Code

**APSK - 25016 Kutulu**

Kutu - Box

Paket / Metre - Package / Meter

154 mt



**25 x 25**

22,00 ₺

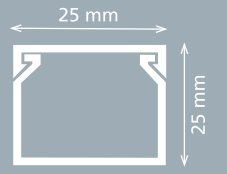

Ürün Kodu - Product Code

**APSK - 25025 Kutulu**

Kutu - Box

Paket / Metre - Package / Meter

96 mt



**30 x 20**

26,00 ₺

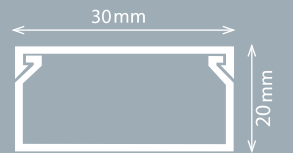

Ürün Kodu - Product Code

**APSK - 30020 Kutulu**

Kutu - Box

Paket / Metre - Package / Meter

100 mt



**40 x 16**

29,50 ₺

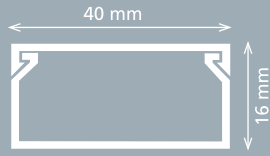

Ürün Kodu - Product Code

**APSK - 40016 Kutulu**

Kutu - Box

Paket / Metre - Package / Meter

84 mt



**40 x 25**

31,00 ₺

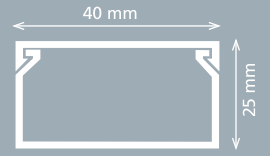

Ürün Kodu - Product Code

**APSK - 40025 Kutulu**

Kutu - Box

Paket / Metre - Package / Meter

80 mt



**40 x 40**

35,40 ₺

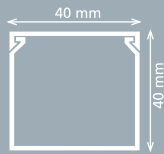

Ürün Kodu - Product Code

**APSK - 40040 Kutulu**

Kutu - Box

Paket / Metre - Package / Meter

72 mt



**50 x 50**

63,50 ₺

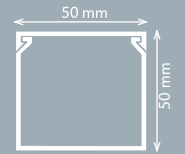

Ürün Kodu - Product Code

**APSK - 50050 Kutulu**

Kutu - Box

Paket / Metre - Package / Meter

48 mt



**60 x 40**

60,00 ₺

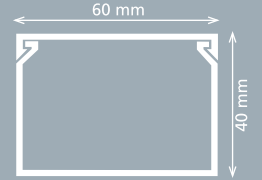

Ürün Kodu - Product Code

**APSK - 60040 Kutulu**

Kutu - Box

Paket / Metre - Package / Meter

48 mt

**60 x 60**

83,00 ₺

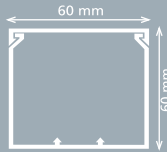

Ürün Kodu - Product Code

**APSK - 60060 Kutulu**

Kutu - Box

Paket / Metre - Package / Meter

40 mt

**YENİ ÜRÜN**  
NEW PRODUCT**75 x 75**

107,00 ₺

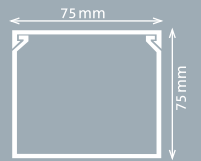

Ürün Kodu - Product Code

**APSK - 75075 Kutulu**

Kutu - Box

Paket / Metre - Package / Meter

24 mt



**80 x 40**

88,00 ₺

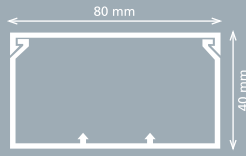

Ürün Kodu - Product Code

**APSK - 80040 Kutulu**

Kutu - Box

Paket / Metre - Package / Meter

36 mt



**80 x 60**

93,00 ₺

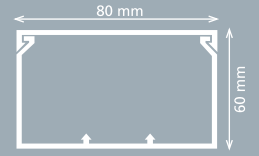

Ürün Kodu - Product Code

**APSK - 80060 Kutulu**

Kutu - Box

Paket / Metre - Package / Meter

32 mt



**100 x 100**

175,00 ₺

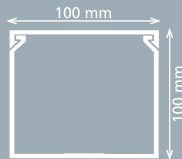

Ürün Kodu - Product Code

**APSK - 100100 Kutulu**

Kutu - Box

Paket / Metre - Package / Meter

16 mt



**100 x 40**

103,00 ₺

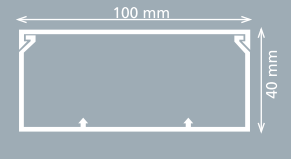

Ürün Kodu - Product Code

**APSK - 100040 Kutulu**

Kutu - Box

Paket / Metre - Package / Meter

28 mt

**100 x 60**

165,00 ₺

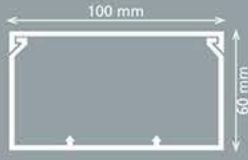

Ürün Kodu - Product Code

APSK - 100060 Kutulu

Kutu - Box

Paket / Metre - Package / Meter

24 mt

**YENİ ÜRÜN  
NEW PRODUCT**

Ara bölme takılabilir - Partition can be attached

**120 x 60**

215,90 ₺

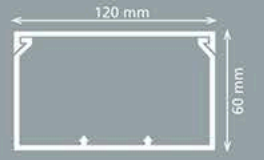

Ürün Kodu - Product Code

APSK - 120060 Kutulu

Kutu - Box

Paket / Metre - Package / Meter

20 mt

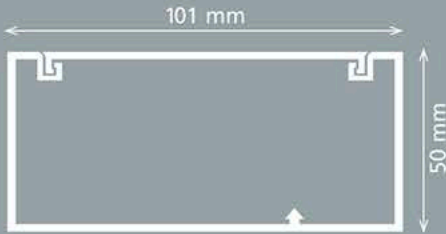
**101 x 50**

Ürün Kodu - Product Code

APSK - 10150

Uzunluk - Length

2m

Kesit - Section

101 x 50

Ambalaj Miktarı (m) - Package Total (m)

16 Mt.

Ambalaj Şekli - Package

Koli - Carton Box

**Fiyat**

195,00 ₺

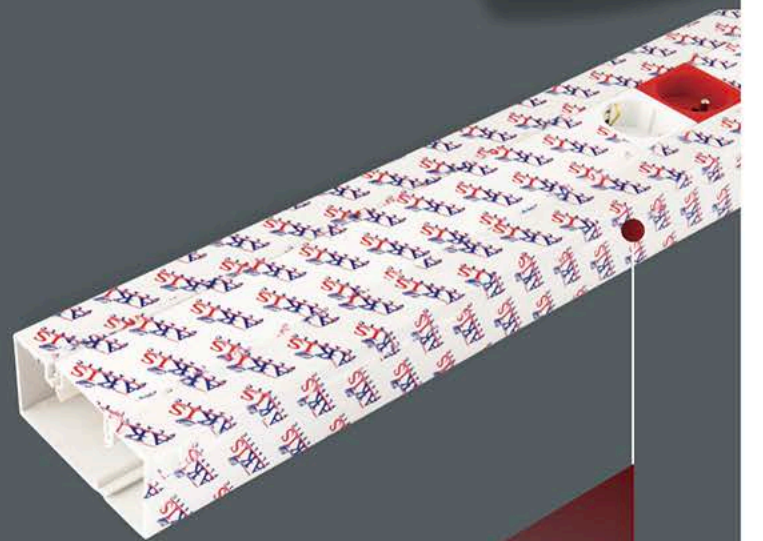
**YENİ ÜRÜN  
NEW PRODUCT****Çerçevesiz  
Priz Montajı**Frameless  
Socket Assembly

**100 x 50**

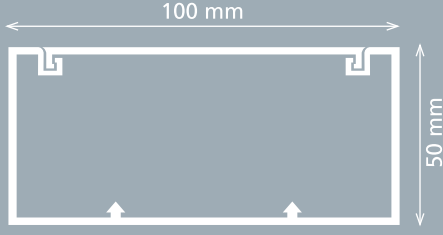

Ürün Kodu - Product Code

**APSK - 100050**

Uzunluk - Length 2m

Kesit - Section 100 x 50

Ambalaj Miktarı (m) - Package Total (m) 16 Mt.

Ambalaj Şekli - Package Koli - Carton Box

**Fiyat 137,00 ₺**

3 ara bölme takılabilir - Up to 3 divider possibility

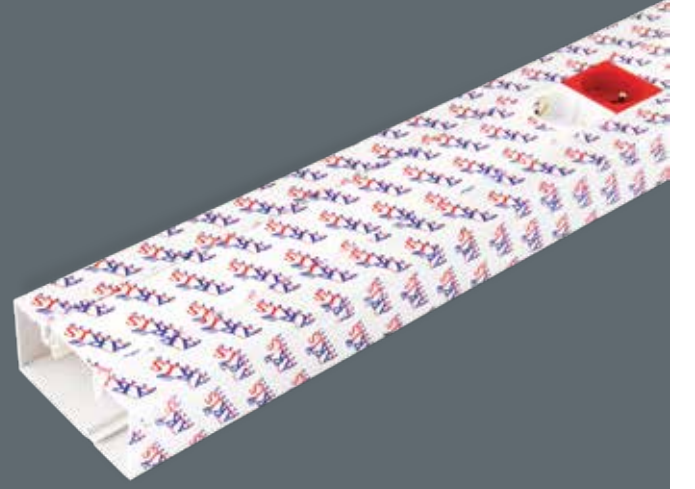

TSE 130124-TSE-02/02

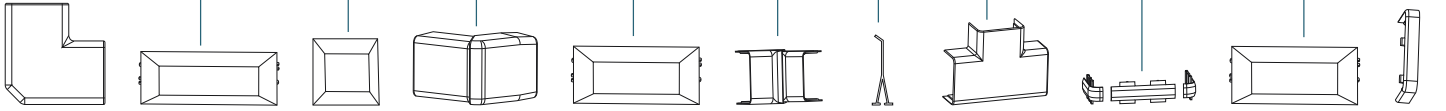
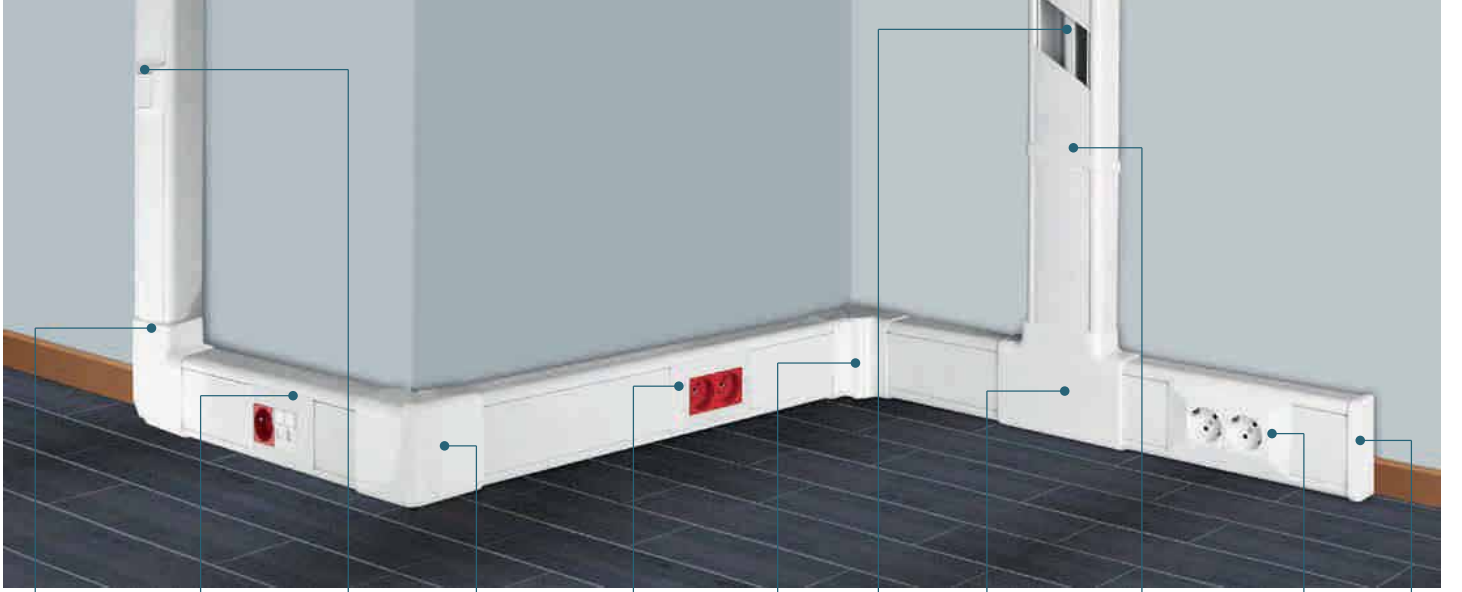

**AP-150AB**

Ara Bölme  
Divider  
Kutu: 100 Mt.  
Box: 100 Pcs.

45,50 ₺

**AP-1501-K**

İç Köşe (Bağlantı Elemanı) Hareketli  
Internal Corner  
Kutu: 12 adet  
Box: 12 Pcs.

44,35 ₺

**AP-150DK**

Dış Köşe (Bağlantı Elemanı) Hareketli  
External Corner  
Kutu: 10 adet  
Box: 10 Pcs.

50,45 ₺

**AP-150L**

L Bağlantı Elemanı 90° Sabit  
90° Corner Piece  
Kutu: 12 adet  
Box: 12 Pcs.

54,43 ₺

**AP-150T**

T Bağlantı Elemanı Sabit  
 T Branches  
 Kutu: 12 Adet  
 Box: 12 Pcs.

55,31 ₺

**AP-150P**

Uç Tipi  
 End Cover  
 Kutu: 24 Adet  
 Box: 24 Pcs.

17,53 ₺

**AP-150KB**

Ek Parça  
 Junction Piece  
 Kutu: 24 Adet  
 Box: 24 Pcs.

19,22 ₺

**AP-150 TP**

Tekli 80 x 80 Priz Montaj Seti  
 Single Frame Cover Set For 80 x 80  
 Kutu: 12 Adet  
 Box: 12 Pcs.

25,50 ₺

**AP-150T45**

Tekli 45 x 45 Priz Montaj Seti  
 Single Frame Cover Set For 45 x 45  
 Kutu: 12 Adet  
 Box: 12 Pcs.

29,65 ₺

**AP-150L45**

İkili 45 x 45 Priz Montaj Seti  
 Double Frame Cover Set For 45 x 45  
 Kutu: 12 Adet  
 Box: 12 Pcs.

34,15 ₺

**AP-150U45**

Üçlü 45 x 45 Priz Montaj Seti  
 Triple Frame Cover Set For 45 x 45  
 Kutu: 12 Adet  
 Box: 12 Pcs.

53,62 ₺

**AP-150D45**

Dörtlü 45 x 45 Priz Montaj Seti  
 Quadruple Frame Cover Set For 45 x 45  
 Kutu: 20 Adet  
 Box: 20 Pcs.

63,51 ₺

**AP-110T**

İngiliz Tip Tekli Priz Çerçevesi  
 British Type Socket Frame  
 Kutu: 100  
 Box: 100

81,00 ₺

**AP-111T**

İngiliz Tip İkili Priz Çerçevesi  
 British Type Double Socket Frame  
 Kutu: 100  
 Box: 100

87,50 ₺

**AP-150FP02**

45x45 Data ve Telefon Priz Kapağı Tekli  
 45x45 Data and Telephone Socket Single  
 Kutu : 10 adet  
 Box : 100 Pcs.

37,32 ₺

**AP-150FP**

45x45 Data ve Telefon Priz Kapağı 2'li  
 45x45 Data and Telephone Socket Double  
 Kutu: 25  
 Box: 100 Pcs.

56,50 ₺

**AP-150UPS**

45 x 45 Tekli UPS Priz  
 Single UPS Socket  
 Kutu: 100 Adet  
 Box: 100 Pcs.

95,24 ₺

**AP-150UPST**

Tekli Şebeke Priz  
 Single Graunded Socket  
 Kutu: 100 Adet  
 Box: 100 Pcs.

81,30 ₺

**AP-150DT02**

CAT5 Data  
 CAT5 Data  
 Kutu: 100 Adet  
 Box: 100 Pcs.

47,89 ₺

**AP-150DT03**

CAT6 Data  
 CAT6 Data  
 Kutu: 100 Adet  
 Box: 100 Pcs.

49,35 ₺



12 mm  
12 mm

10,30 ₺

**12 x 12**

Ürün Kodu : APSKY 12012  
Kablo Kanalı Bantlı  
Ambalaj : 320 m  
Self Adhesive Cable Trunking  
Box : 320 m



15 mm  
10 mm

12,30 ₺

**15 x 10**

Ürün Kodu : APSKY 15010  
Kablo Kanalı Bantlı  
Ambalaj : 300 m  
Self Adhesive Cable Trunking  
Box : 300 m



16 mm  
16 mm

12,30 ₺

**16 x 16**

Ürün Kodu : APSKY 16016  
Kablo Kanalı Bantlı  
Ambalaj : 250 m  
Self Adhesive Cable Trunking  
Box : 250 m



20 mm  
10 mm

14,50 ₺

**20 x 10**

Ürün Kodu : APSKY 20010  
Kablo Kanalı Bantlı  
Ambalaj : 240 m  
Self Adhesive Cable Trunking  
Box : 240 m



25 mm  
16 mm

18,60 ₺

**25 x 16**

Ürün Kodu : APSKY 25016  
Kablo Kanalı Bantlı  
Ambalaj : 154 m  
Self Adhesive Cable Trunking  
Box : 154 m



25 mm  
25 mm

24,00 ₺

**25 x 25**

Ürün Kodu : APSKY 25025  
Kablo Kanalı Bantlı  
Ambalaj : 96 m  
Self Adhesive Cable Trunking  
Box : 96 m



40 mm  
16 mm

31,50 ₺

**40 x 16**

Ürün Kodu : APSKY 40016  
Kablo Kanalı Bantlı  
Ambalaj : 84 m  
Self Adhesive Cable Trunking  
Box : 84 m



40 mm  
25 mm

34,30 ₺

**40 x 25**

Ürün Kodu : APSKY 40025  
Kablo Kanalı Bantlı  
Ambalaj : 80 m  
Self Adhesive Cable Trunking  
Box : 80 m



40 mm  
40 mm

42,00 ₺

**40 x 40**

Ürün Kodu : APSKY 40040  
Kablo Kanalı Bantlı  
Ambalaj : 72 m  
Self Adhesive Cable Trunking  
Box : 72 m



60 mm  
40 mm

70,50 ₺

**60 x 40**

Ürün Kodu : APSKY 60040  
Kablo Kanalı Bantlı  
Ambalaj : 48 m  
Self Adhesive Cable Trunking  
Box : 48 m

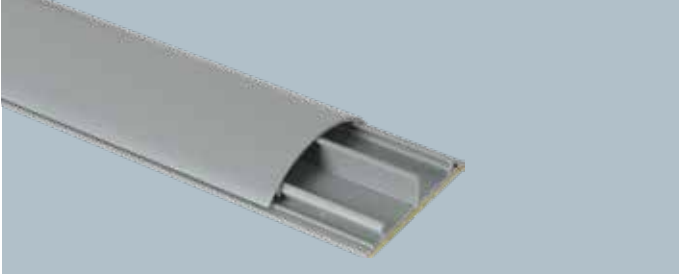
**50 x 12**

70,00 ₺

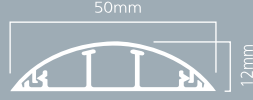

Ürün Kodu - Product Code  
**APSZ 500 x 12**

Ambalaj Miktarı - Package Total 60 m

Ambalaj Şekli - Package Kutu - Box

**50 x 12**

81,50 ₺

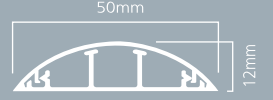

Ürün Kodu - Product Code  
**APSZY 500 x 12**

Ambalaj Miktarı - Package Total 60 m

Ambalaj Şekli - Package Kutu - Box

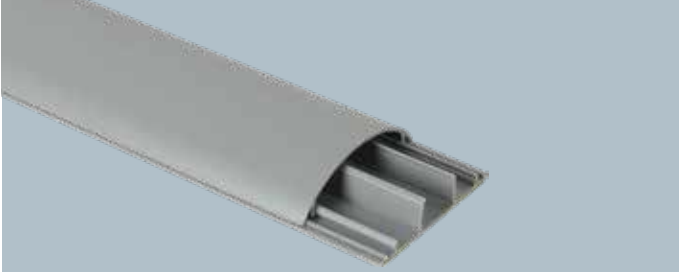
**70 x 20**

134,00 ₺

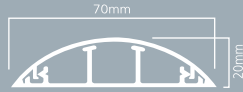

Ürün Kodu - Product Code  
**APSZ 700 x 12**

Ambalaj Miktarı - Package Total 60 m

Ambalaj Şekli - Package Kutu - Box

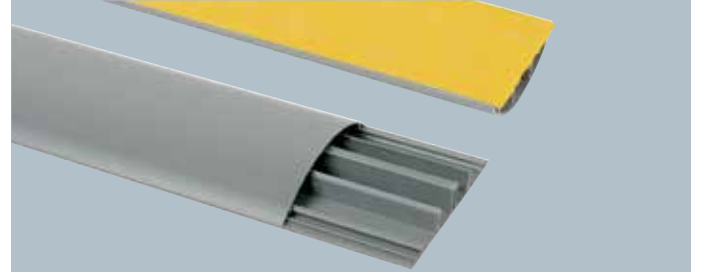
**70 x 20**

150,00 ₺

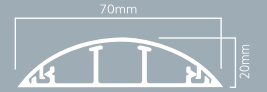

Ürün Kodu - Product Code  
**APSZY 700 x 12**

Ambalaj Miktarı - Package Total 60 m

Ambalaj Şekli - Package Kutu - Box

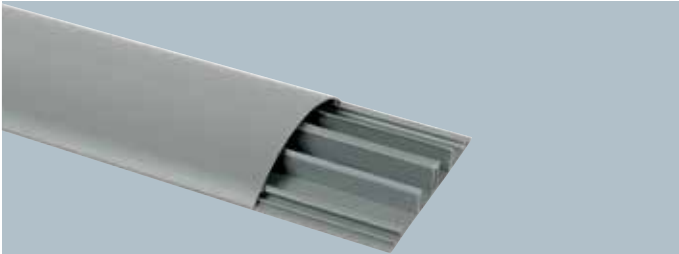
**90 x 20**

174,00 ₺

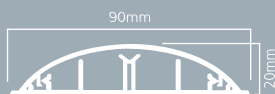

Ürün Kodu - Product Code  
**APSZ 900 x 20**

Ambalaj Miktarı - Package Total 20 m

Ambalaj Şekli - Package Kutu - Box

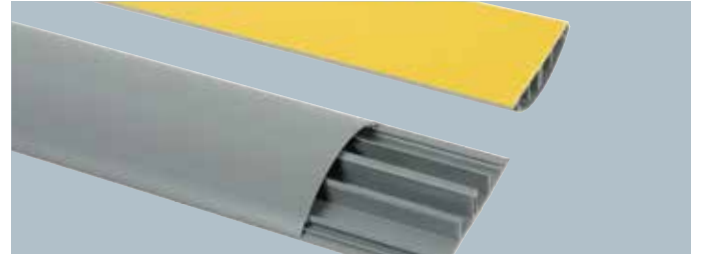
**90 x 20**

190,00 ₺

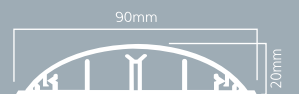

Ürün Kodu - Product Code  
**APSZY 900 x 20**

Ambalaj Miktarı - Package Total 20 m

Ambalaj Şekli - Package Kutu - Box

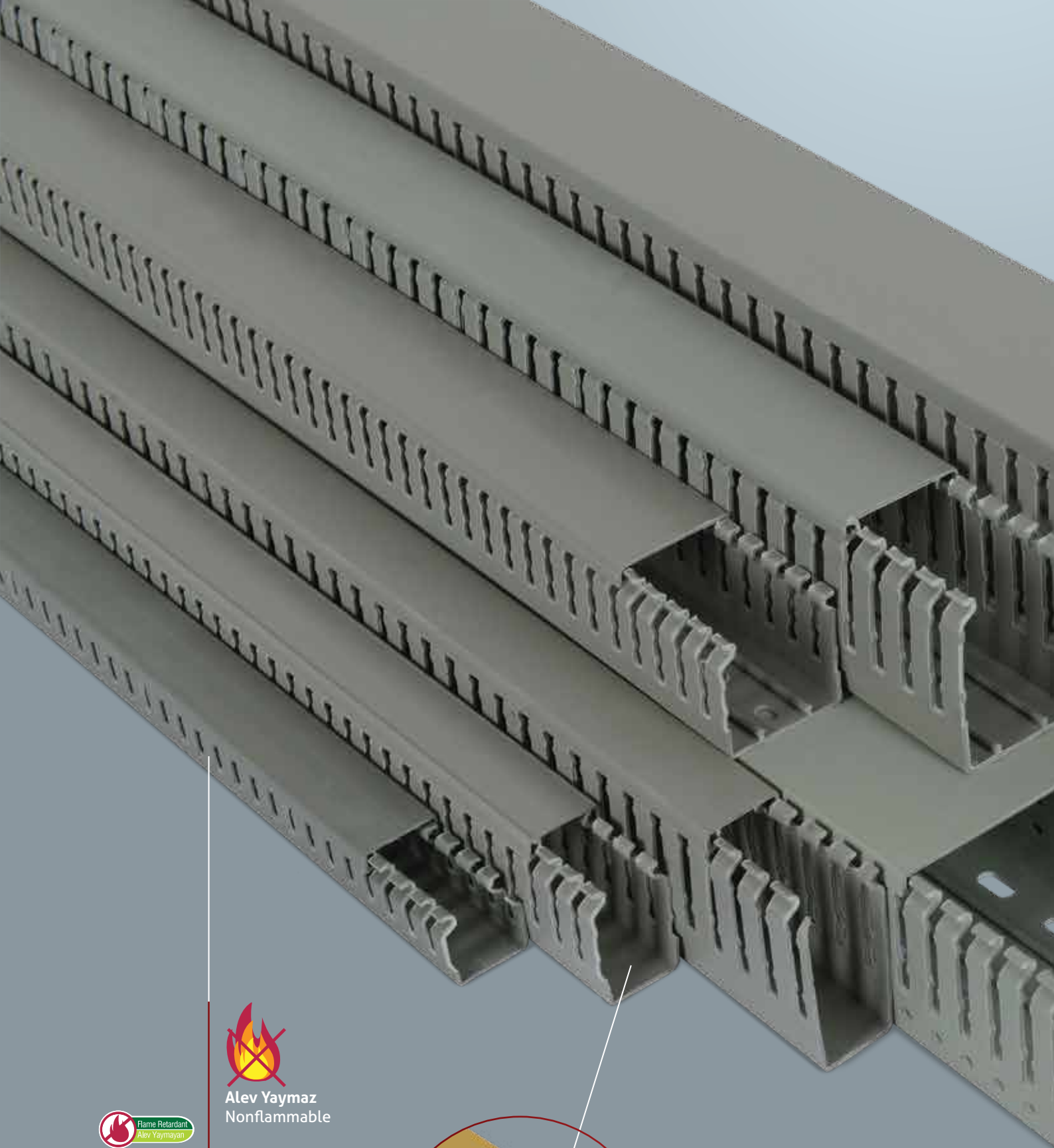

**Alev Yaymaz**  
Nonflammable



Flame Retardant  
Alev Yayımayan

#### Ürün Renkleri - Product Colors



Beyaz  
White



Mavi  
Blue



Gri  
Grey

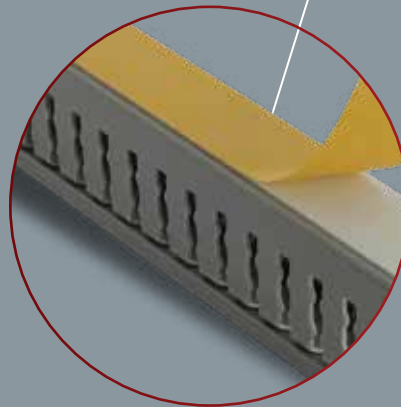

Kolay yapışmayı sağlayan,  
Çift taraflı bant kullanılabilir.  
Easy attached double sided adhesive  
tape could be used





# Pano tipi kablo kanallarımızın teknik özellikleri

## Technical Specifications for our Slotted Cable Trunkings

Özel kapak dizaynı sayesinde kolay kapanma ve açılma, dikey pozisyonda dahi en iyi performans. Special design of cover provides easy closing and opening and show the best performance even in vertical position.

Alt kırılma noktası sayesinde yan keski vb. alet kullanarak kanal yan duvarının kolayca kırılarak hızlı montaj sağlanması. With the cutting point at the bottom easily breaking sides and installed on the wall without using any tool.

Üst kırılma noktası sayesinde herhangi bir el aletine ihtiyaç duymadan kanal yanlarında bulunan tırnakların kolayca kırılarak hızlı montaj sağlanması. The breaking points on the top provide easy breaking side nails and fast installation.

Tabanda bulunan raylar sayesinde kanal tutucu vb. aksesuarların kolayca montajı. The rails on the bottom helps to assembly holders and other accessories easily.



**25 x 25**

43,55 ₺

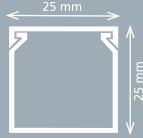

Ürün Kodu - Product Code

**APSG-25025**

Ambalaj Miktarı - Package total (m) 100 m

Ambalaj şekli - Package Kutu - Box



**25 x 40**

55,00 ₺

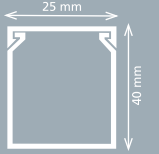

Ürün Kodu - Product Code

**APSG-25040**

Ambalaj Miktarı - Package total (m) 80 m

Ambalaj şekli - Package Kutu - Box

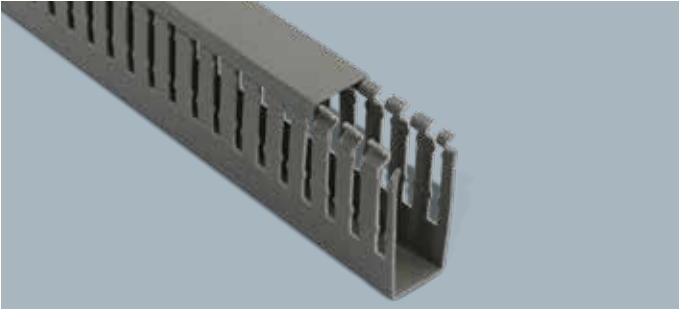

**25 x 60**

89,00 ₺

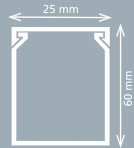

Ürün Kodu - Product Code

**APSG-25060**

Ambalaj Miktarı - Package total (m) 48 m

Ambalaj şekli - Package Kutu - Box

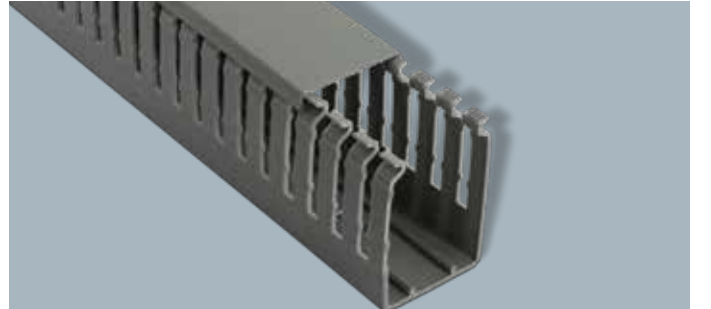

**40 x 40**

71,00 ₺

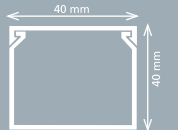

Ürün Kodu - Product Code

**APSG-40040**

Ambalaj Miktarı - Package total (m) 72 m

Ambalaj şekli - Package Kutu - Box

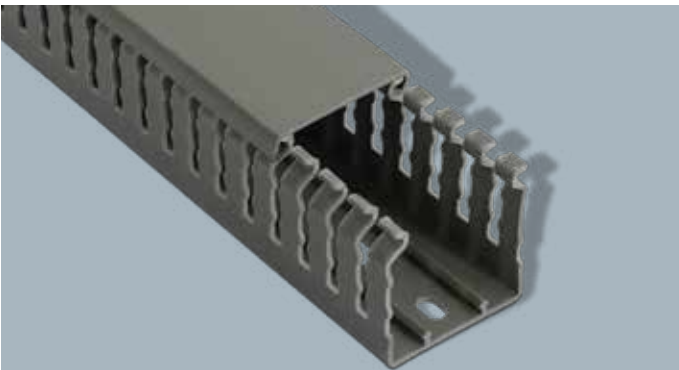

**40 x 60**

94,00 ₺

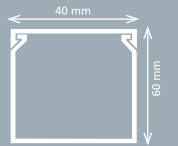

Ürün Kodu - Product Code

**APSG-40060**

Ambalaj Miktarı - Package total (m) 48 m

Ambalaj şekli - Package Kutu - Box

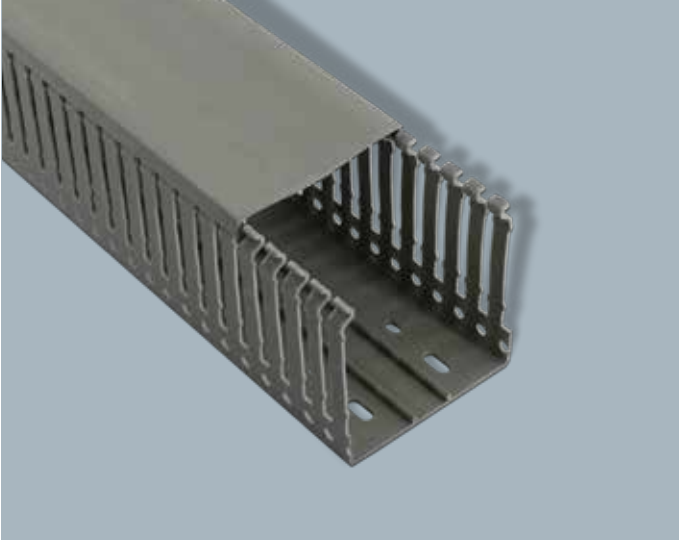
**60 x 60**

121,00 ₺

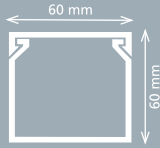

Ürün Kodu - Product Code

**APSG-60060**

Ambalaj Miktarı - Package total (m) 32 m

Ambalaj şekli - Package Kutu - Box

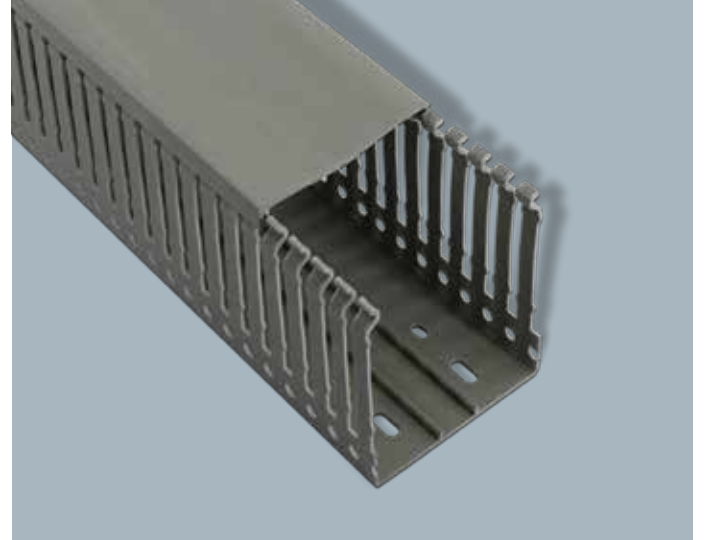
**60 x 80**

149,00 ₺

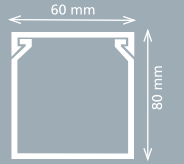

Ürün Kodu - Product Code

**APSG-60080**

Ambalaj Miktarı - Package total (m) 24 m

Ambalaj şekli - Package Kutu - Box

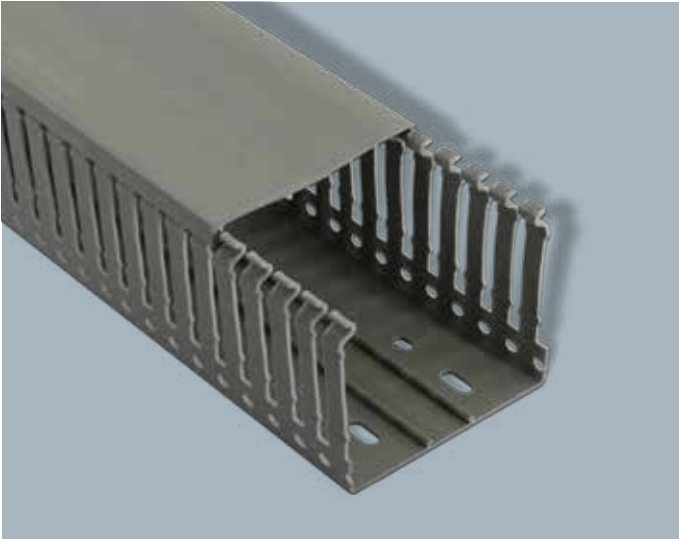
**80 x 60**

170,00 ₺

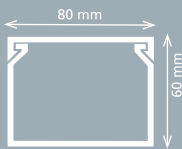

Ürün Kodu - Product Code

**APSG-80060**

Ambalaj Miktarı - Package total (m) 24 m

Ambalaj şekli - Package Kutu - Box

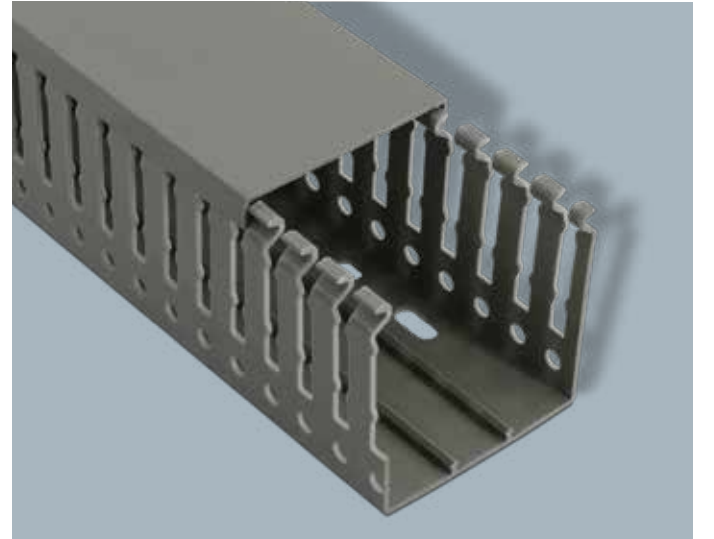
**80 x 80**

216,00 ₺

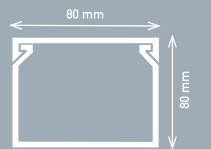

Ürün Kodu - Product Code

**APSG-80080**

Ambalaj Miktarı - Package total (m) 18 m

Ambalaj şekli - Package Kutu - Box

**YENİ ÜRÜN**  
NEW PRODUCT



### 100'LÜK ASPIRATÖR - ASPIRATOR

Ürün Kodu - Product Code

**AK - C100**

Çalışma Akımı - Operation Voltage 220-240 V / 50-60 Hz

Emiş Hacmi - Airflow 100 m<sup>3</sup>/h

Devir Hızı - Round Speed 2250 rpm

Güç - Power 12W

**Fiyat 375,00 ₺**

Kutu - Box Pcs. : 20



**YENİ ÜRÜN**  
NEW PRODUCT



### 120'LİK ASPIRATÖR - ASPIRATOR

Ürün Kodu - Product Code

**AK - C120**

Çalışma Akımı - Operation Voltage 220-240 V / 50-60 Hz

Emiş Hacmi - Airflow 120 m<sup>3</sup>/h

Devir Hızı - Round Speed 1900 rpm

Güç - Power 15W

**Fiyat 395,00 ₺**

Kutu - Box Pcs. : 20



**YENİ ÜRÜN**  
NEW PRODUCT



### 150'LİK ASPIRATÖR - ASPIRATOR

Ürün Kodu - Product Code

**AK - C150**

Çalışma Akımı - Operation Voltage 220-240 V / 50-60 Hz

Emiş Hacmi - Airflow 150 m<sup>3</sup>/h

Devir Hızı - Round Speed 1800 rpm

Güç - Power 20W

**Fiyat 545,00 ₺**

Kutu - Box Pcs. : 20



# ABS panolarımızın teknik özellikleri

Technical Specification of  
ABS Panel Boards



IP65



IK Derecesi  
IK Degree : IK08

FİYAT SORUNUZ

FİYAT SORUNUZ

Kilit Sistemi  
Lock System

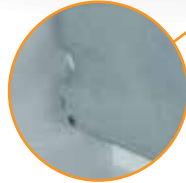

1 mm Galvanizli Çelik Montaj Plakası  
1 mm Galvanized Steel Mounting Plate

YENİ ÜRÜN  
NEW PRODUCT

YENİ ÜRÜN  
NEW PRODUCT

YENİ ÜRÜN  
NEW PRODUCT



ABS PC IP65 CE

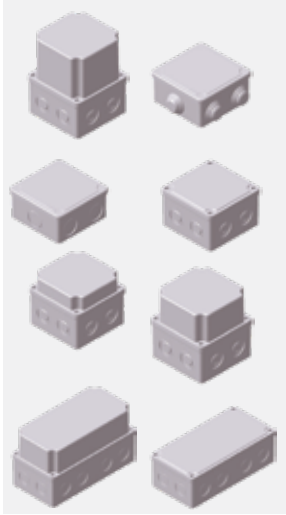

## Kapaklı Buat - Thermoplastic Box

KOD CODE	ÜRÜN ÖLÇÜLERİ SIZE	ÜRÜN PRODUCT	SERTİFİKA	RENK COLOUR	KOLİ ADEDİ BOX PCS	FİYAT
<b>A8585420-62</b>	85 x 85 x 42	Sıva Üstü Kare Buat Thermoplastic Box	IP40	Gri-Grey	60	36.25 ₺
<b>B858542</b>	85 x 85 x 42	Sıva Üstü Kare Buat Vidalı Thermoplastic Box	IP40	Gri-Grey	60	37.90 ₺
<b>A11011072-68</b>	110 x 110 x 72	Sıva Üstü Kare Buat Thermoplastic Box	IP40	Gri-Grey	48	69.95 ₺
<b>A11011097-68</b>	110 x 110 x 97	Sıva Üstü Kare Buat Thermoplastic Box	IP65	Gri-Grey	48	76.00 ₺
<b>A110110122-68</b>	110 x 220 x 122	Sıva Üstü Kare Buat Thermoplastic Box	IP65	Gri-Grey	48	79.00 ₺
<b>A110110147-68</b>	110 x 110 x 147	Sıva Üstü Kare Buat Thermoplastic Box	IP65	Gri-Grey	48	85.00 ₺
<b>A11022072-68</b>	110 x 220 x 72	Sıva Üstü Kare Buat Thermoplastic Box	IP65	Gri-Grey	24	105.00 ₺

## Perdeli Panolar

**YENİ ÜRÜN**  
NEW PRODUCT



### TEKNİK ÖZELLİKLER

Ham madde : ABS (Ral 7035 Gri) - Isı dayanıklı : -40°C / +80°C  
Darbe dayanıklı  
Standart tip panolar için 650°C kızaaran tel deneyi  
HF yanmaz panolar için 960°C kızaaran tel deneyi  
Paslanmaz çelik vidalı kapak - Taban sacı - Kilit sistemi  
Montaj rayı ve klemens takmaya müsait gövde tasarımı  
Alçak gerilim şalt ekipmanları montaja müsait yapı

### TECHNICAL SPECIFICATIONS

Material : ABS (Ral 7035 Gri) - Health Strangth : -40°C / +80°C  
Impact resitant  
650°C glow wire test for standart type  
960°C glow wire test for HF type  
Stainless stell screws for cover - Stainless temm base plate  
Lock system - Design provided installation for DIN rails and terminals  
Suitable to assembly low vottage swichtchgear equipment



## ABS Perdeli Opak Pano

KOD-CODE	ÜRÜN ÖLÇÜLERİ -SIZE	ÖLÇÜ -SIZE	KOLİ ADEDİ-BOX PCS	FİYAT
<b>AKABP-250150</b>	25x35x15	2x8 = 18 Otomat	1	1.087,00 ₺
<b>AKABP-300400</b>	30x40x17	2x12 = 24 Otomat	1	1.470,00 ₺
<b>AKABP-350500</b>	35x50x19	3x14 = 42 Otomat	1	1.965,00 ₺
<b>AKABP-400200</b>	40x60x20	4x17 = 68 Otomat	1	2.580,00 ₺

## ABS Perdeli Şeffaf Pano

KOD-CODE	ÜRÜN ÖLÇÜLERİ -SIZE	ÖLÇÜ -SIZE	KOLİ ADEDİ-BOX PCS	FİYAT
<b>AKAPCP-250150</b>	25x35x15	2x8 = 18 Otomat	1	1.200,00 ₺
<b>AKAPCP-300400</b>	30x40x17	2x12 = 24 Otomat	1	1.580,00 ₺
<b>AKAPCP-350500</b>	35x50x19	3x14 = 42 Otomat	1	2.400,00 ₺
<b>AKAPCP-400200</b>	40x60x20	4x17 = 68 Otomat	1	3.100,00 ₺

## ABS Pano - ABS Board



### TEKNİK ÖZELLİKLER

Hammadde : ABS (Ral 7035 Gri)  
 Isı dayanıklı : -40°C / +80°C  
 Darbe dayanıklı  
 Standart tip panolar için 650°C kızaran tel deneyi  
 HF yanmaz panolar için 960°C kızaran tel deneyi  
 Paslanmaz çelik vidalı kapak  
 Taban sacı  
 Kilit sistemi  
 Montaj rayı ve klemens takmaya müsait gövde tasarımı  
 Alçak gerilim şalt ekipmanları montaja müsait yapı

### TECHNICAL SPECIFICATIONS

Material : ABS (Ral 7035 Gri)  
 Health Strangth : -40°C / +80°C  
 Impact resitant  
 650°C glow wire test for standart type  
 960°C glow wire test for HF type  
 Stainless stell screws for cover  
 Stainless temm base plate  
 Lock system  
 Design provided installation for DIN rails and terminals  
 Suitable to assembly low voltage swichtchgear equipment



IP65

KOD CODE	ÜRÜN ÖLÇÜLERİ SIZE	KOLİ ADEDİ BOX PCS	FİYAT
AKAB - 200130	200x300x130	1	560,00 ₺
AKAB - 250150	250x350x150	1	770,00 ₺
AKAB - 300400	300x400x170	1	940,00 ₺
AKAB - 300220	300x400x220	1	1.115,00 ₺
AKAB - 350190	350x500x190	1	1,395,00 ₺
AKAB - 400180	400x500x180	1	1.465,00 ₺
AKAB - 400240	400x500x240	1	1.720,00 ₺
AKAB - 400200	400x600x200	1	1.790,00 ₺
AKAB - 500230	500x600x230	1	2.700,00 ₺
AKAB - 500250	500x700x250	1	3.040,00 ₺
AKAB - 600800	600x800x280	1	

ABS IP65 CE

## PC Şeffaf Kapaklı Panolar - Panel Boards With Pc Transparent Door



### TEKNİK ÖZELLİKLER

Hammadde : ABS (Ral 7035 Gri)  
Isı dayanıklı : -40°C / +80°C  
Darbe dayanıklı  
Standart tip panolar için 650°C kızaran tel deneyi  
HF yanmaz panolar için 960°C kızaran tel deneyi  
Paslanmaz çelik vidalı kapak  
Taban sacı  
Kilit sistemi  
Montaj rayı ve klemens takmaya müsait gövde tasarımı  
Alçak gerilim şalt ekipmanları montaja müsait yapı

### TECHNICAL SPECIFICATIONS

Material : ABS (Ral 7035 Gri)  
Health Strangth : -40°C / +80°C  
Impact resitant  
650°C glow wire test for standart type  
960°C glow wire test for HF type  
Steinless stell screws for cover  
Steinless temm base plate  
Lock system  
Design provided installation for DIN rails and terminals  
Suitable to assembly low voltage swichtchgear equipment



KOD CODE	ÜRÜN ÖLÇÜLERİ SIZE	KOLİ ADEDİ BOX PCS	FİYAT
AKPC - 200130	200x300x130	1	600,00 ₺
AKPC - 250150	250x350x150	1	840,00 ₺
AKPC - 300400	300x400x170	1	995,00 ₺
AKPC - 300220	300x400x220	1	1.150,00 ₺
AKPC - 350190	350x500x190	1	1.505,00 ₺
AKPC - 400180	400x500x180	1	1.620,00 ₺
AKPC - 400240	400x500x240	1	1.950,00 ₺
AKPC - 400200	400x600x200	1	1.995,00 ₺
AKPC - 500230	500x600x230	1	3.156,00 ₺
AKPC - 500250	500x700x250	1	3.578,00 ₺
AKPC - 600800	600x800x280	1	☎

ABS PC IP65 CE





## Plastik Susta (Takviyeli) - Plastic Strina (Consolidated)

KOD CODE	ÜRÜN ÖLÇÜLERİ SIZE	KOLİ ADEDİ BOX PCS	FİYAT
APP10005	5 mt plastik susta - 5 mt plastic strina consolidated	60	3,50 \$
APP10010	10 mt plastik susta - 10 mt plastic strina consolidated	50	4,60 \$
APP10015	15 mt plastik susta - 15 mt plastic strina consolidated	40	6,90 \$
APP10020	20 mt plastik susta - 20 mt plastic strina consolidated	30	9,20 \$
APP10025	25 mt plastik susta - 25 mt plastic strina consolidated	25	1.140 \$
APP10030	30 mt plastik susta - 30 mt plastic strina consolidated	20	13,65 \$



## Çelik Susta - Steel Strina

KOD CODE	ÜRÜN ÖLÇÜLERİ SIZE	KOLİ ADEDİ BOX PCS	FİYAT
APC10005	5 mt çelik susta - 5 mt steel strina	50	4,45 \$
APC10010	10 mt çelik susta - 10 mt steel strina	40	6,95 \$
APC10015	15 mt çelik susta - 15 mt steel strina	30	10,15 \$
APC10020	20 mt çelik susta - 20 mt steel strina	20	13,30 \$
APC10025	25 mt çelik susta - 25 mt steel strina	15	15,80 \$
APC10030	30 mt çelik susta - 30 mt steel strina	10	18,95 \$



## Çelik Susta (Takviyeli) - Steel Strina (Consolidated)

KOD CODE	ÜRÜN ÖLÇÜLERİ SIZE	KOLİ ADEDİ BOX PCS	FİYAT
APT10005	5 mt çelik susta - 5 mt steel strina consolidated	60	6,32 \$
APT10010	10 mt çelik susta - 10 mt steel strina consolidated	50	8,85 \$
APT10015	15 mt çelik susta - 15 mt steel strina consolidated	40	13,30 \$
APT10020	20 mt çelik susta - 20 mt steel strina consolidated	30	17,70 \$
APT10025	25 mt çelik susta - 25 mt steel strina consolidated	25	22,15 \$
APT10030	30 mt çelik susta - 30 mt steel strina consolidated	20	26,55 \$

**YENİ ÜRÜN**  
NEW PRODUCT

**CCA KABLO**



## MAKARALI UZATMA KABLOSU - ROLLER EXTENSION CABLE

KOD CODE	KESİT SIZE	ÜRÜN PRODUCT	KESİT SECTION	KOLİ İÇİ CTN - PCS	FİYAT
AK 300	Boş Makara	Makaralı Uzatma Kablosu	Boş / Spool Empty	4	490,00 ₺
AK 315-20	20 MT	Makaralı Uzatma Kablosu	3 x 1,5 mm <sup>2</sup>	4	☎
AK 315-35	35 MT	Makaralı Uzatma Kablosu	3 x 1,5 mm <sup>2</sup>	4	☎
AK 315-50	50 MT	Makaralı Uzatma Kablosu	3 x 1,5 mm <sup>2</sup>	4	☎
AK 325-20	20 MT	Makaralı Uzatma Kablosu	3 x 2,5 mm <sup>2</sup>	4	☎
AK 325-30	30 MT	Makaralı Uzatma Kablosu	3 x 2,5 mm <sup>2</sup>	4	☎
AK 325-40	40 MT	Makaralı Uzatma Kablosu	3 x 2,5 mm <sup>2</sup>	4	☎
AK 325-50	50 MT	Makaralı Uzatma Kablosu	3 x 2,5 mm <sup>2</sup>	4	☎

# Tesisat Grubu

Installation  
Group

Çelik  
Steel

Golvaniz  
Galvanized

Plastik Sprial  
plastic Spiral

Kılavuz Telli  
With Guide Wire

## PVC Düz Boru 3m PVC Rigid Conduit Hafif Seri / Light Gauge



Alev Yayımayan  
Yayla Bükülebilir

Self Extinguishing  
Malleable Rigid Conduit

Ürün Renkleri - Product Colors



Gri  
Grey

Siyah  
Black

KOD CODE	DIŞ ÇAP (MM) EX. DIAMETER (MM)	İÇ ÇAP (MM) INT. DIAMETER (MM)	AMBALAJ PACKAGING	FİYAT	MUFLU FİYAT
AK 10121	Ø 16	14,5	102 m	16,50 ₺	20.50 ₺
AK 10122	Ø 20	17,5	102 m	24,00 ₺	28.00 ₺
AK 10123	Ø 25	22,1	51 m	32,00 ₺	37.50 ₺
AK 10124	Ø 32	29,2	45 m	53,00 ₺	61.50 ₺

 **320 Newton**

TEKNİK ÖZELLİKLER		TECHNICAL SPECIFICATIONS	
Standart	: EN 61386-21 / 22	Standart	: En 61386-21 / 22
Malzeme	: PVC Bazlı Termoplastik	Material	: PVC Based Thermoplastic
Sıkıştırma Dayanımı	: 320 Newton / 60 sn./sec / 23 +2°C	Compression Resistance	: 320 Newton / 60 sn./sec / 23 +2°C
Darbe Dayanımı	: 1 kg. / 100 mm / -25°C	Impact Resistance	: 1 kg. / 100 mm / -25°C
Çalışma Ortamı Sıcaklığı	: -25°C + 60°C	Working Temperature	: -25°C + 60°C
Yalıtım Gerilimi	: 2000 V./50 H. / 15 dak.	Insulating Strength	: 2000 V./50 Hz. / 15 min.
Kendiliğinden Sönen PVC Malzeme	: UL94 V0	PVC Material (Self Extinguishing)	: UL94 V0
Boru Boyu	: 3 m	Conduit Length	: 3 m



## PP SİRİRAL BORU REKORU (RECORD)

ANMA ÇAPI	Ø 16	Ø 20	Ø 25	Ø 32
AMBALAJ - PCS.	100	100	100	100
KOD - CODE	AKK - 16 - PP	AKR - 20 - PP	AKR - 25 - PP	AKR - 32 - PP
FİYAT	20,50 ₺	22,00 ₺	2390 ₺	31,00 ₺



## PP DİRSEK - ELBOW

ANMA ÇAPI	Ø 16	Ø 20	Ø 25	Ø 32
AMBALAJ - PCS.	100	100	100	100
KOD - CODE	AKD - 16 - PP	AKD - 20 - PP	AKD - 25 - PP	AKD - 32 - PP
FİYAT	11,50 ₺	14,75 ₺	18,75 ₺	26,80 ₺



## PP AÇILIR DİRSEK - ELBOW OPENS

ANMA ÇAPI	Ø 16	Ø 20	Ø 25	Ø 32
AMBALAJ - PCS.	25	25	25	15
KOD - CODE	AKA - 16 - PP	AKA - 20 - PP	AKA - 25 - PP	AKA - 32 - PP
FİYAT	32,36 ₺	43,15 ₺	53,95 ₺	62,94 ₺



## PP T BAĞLANTI - T LINK

ANMA ÇAPI	Ø 16	Ø 20	Ø 25	Ø 32
AMBALAJ - PCS.	100	100	100	100
KOD - CODE	AKT - 16 - PP	AKT - 20 - PP	AKT - 25 - PVC	AKT - 32 - PP
FİYAT	16,18 ₺	19,78 ₺	25,95 ₺	32,36 ₺

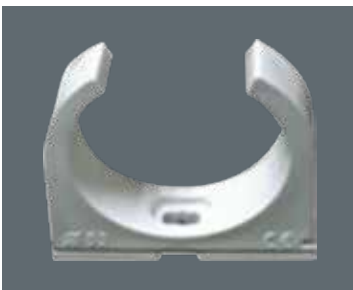

## AY KROŞE - MOON CROCHET

ANMA ÇAPI	Ø 16	Ø 20	Ø 25	Ø 32
AMBALAJ - PCS.	50	50	50	25
KOD - CODE	AKS - 16 - PP	AKS - 25 - PP	AKS - 25 - PP	AKS - 32 - PP
FİYAT	7,50 ₺	9,25 ₺	10,95 ₺	14,75 ₺

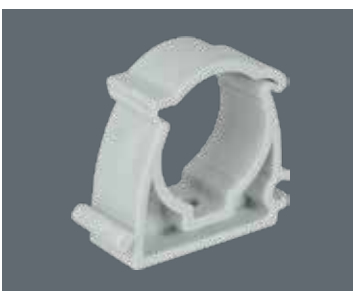

## KAPAKLI KROŞE - CAPPED MOON

ANMA ÇAPI	Ø 16	Ø 20	Ø 25	Ø 32
AMBALAJ - PCS.	100	100	100	100
KOD - CODE	AKK - 16 - PP	AKK - 20 - PP	AKK - 25 - PP	AKK - 32 - PP
FİYAT	4,50 ₺	4,95 ₺	5,35 ₺	6,00 ₺

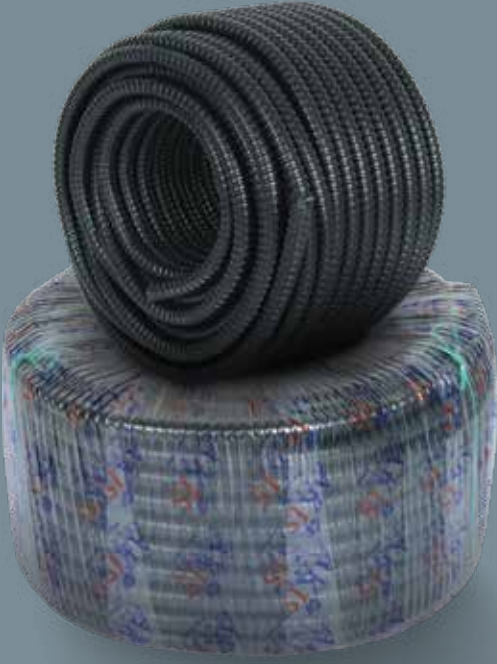

## PVC İZOLELİ ÇELİK SİRAL BORU

### PVC INSULATED STEEL SPIRAL CONDUIT

KOD CODE	ÜRÜN ADI PRODUCT NAME	MT. PACK	FİYAT
APS - ICS 9	9 mm İzoleli Çelik Spiral Boru 9 mm Insulated Steel Spirals	50	17,50 ₺
APS - ICS 11	11 mm İzoleli Çelik Spiral Boru 11 mm Insulated Steel Spirals	50	19,10 ₺
APS - ICS 14	14 mm İzoleli Çelik Spiral Boru 14 mm Insulated Steel Spirals	50	23,30 ₺
APS - ICS 16	16 mm İzoleli Çelik Spiral Boru 16 mm Insulated Steel Spirals	50	24,95 ₺
APS - ICS 18	18 mm İzoleli Çelik Spiral Boru 18 mm Insulated Steel Spirals	50	28,80 ₺
APS - ICS 21	21 mm İzoleli Çelik Spiral Boru 21 mm Insulated Steel Spirals	50	34,50 ₺
APS - ICS 26	26 mm İzoleli Çelik Spiral Boru 26 mm Insulated Steel Spirals	25	42,75 ₺
APS - ICS 29	29 mm İzoleli Çelik Spiral Boru 29 mm Insulated Steel Spirals	25	46,25 ₺
APS - ICS 32	32 mm İzoleli Çelik Spiral Boru 32 mm Insulated Steel Spirals	25	52,10 ₺
APS - ICS 37	37 mm İzoleli Çelik Spiral Boru 37 mm Insulated Steel Spirals	25	66,85 ₺
APS - ICS 40	40 mm İzoleli Çelik Spiral Boru 40 mm Insulated Steel Spirals	25	74,34 ₺
APS - ICS 42	42 mm İzoleli Çelik Spiral Boru 42 mm Insulated Steel Spirals	25	76,92 ₺
APS - ICS 45	45 mm İzoleli Çelik Spiral Boru 45 mm Insulated Steel Spirals	25	93,30 ₺
APS - ICS 50	50 mm İzoleli Çelik Spiral Boru 50 mm Insulated Steel Spirals	25	104,00 ₺

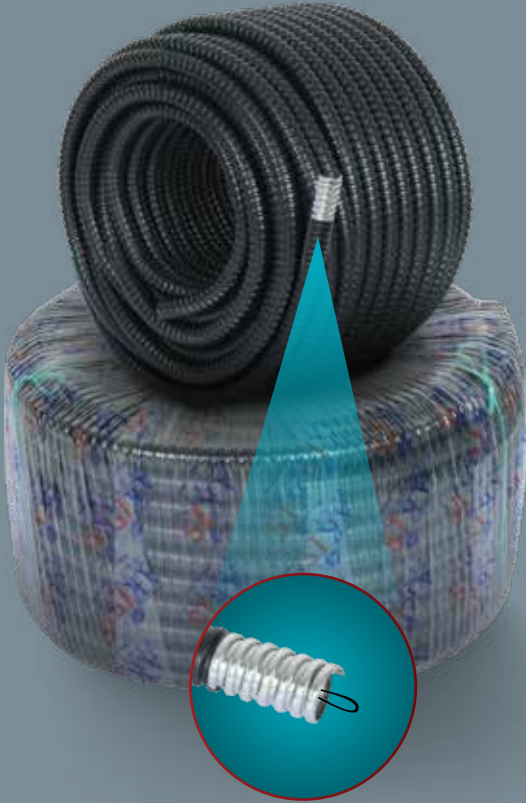

## KILAVUZ TELLİ İZOLELİ ÇELİK SİRAL BORU

### PVC INSULATED STEEL SPIRAL CONDUIT WITH GUIDE

KOD CODE	ÜRÜN ADI PRODUCT NAME	MT. PACK	FİYAT
APS - ICST 9	9 mm İzoleli Çelik Spiral Boru Telli 9 mm Insulated Steel Spirals Conduit With Guide	50	18,65 ₺
APS - ICST 11	11 mm İzoleli Çelik Spiral Boru Telli 11 mm Insulated Steel Spirals Conduit With Guide	50	21,75 ₺
APS - ICST 14	14 mm İzoleli Çelik Spiral Boru Telli 14 mm Insulated Steel Spirals Conduit With Guide	50	25,50 ₺
APS - ICST 16	16 mm İzoleli Çelik Spiral Boru Telli 16 mm Insulated Steel Spirals Conduit With Guide	50	27,60 ₺
APS - ICST 18	18 mm İzoleli Çelik Spiral Boru Telli 18 mm Insulated Steel Spirals Conduit With Guide	50	31,10 ₺
APS - ICST 21	21 mm İzoleli Çelik Spiral Boru Telli 21 mm Insulated Steel Spirals Conduit With Guide	50	37,00 ₺
APS - ICST 26	26 mm İzoleli Çelik Spiral Boru Telli 26 mm Insulated Steel Spirals Conduit With Guide	25	45,85 ₺
APS - ICST 29	29 mm İzoleli Çelik Spiral Boru Telli 29 mm Insulated Steel Spirals Conduit With Guide	25	49,75 ₺
APS - ICST 32	32 mm İzoleli Çelik Spiral Boru Telli 32 mm Insulated Steel Spirals Conduit With Guide	25	56,75 ₺
APS - ICST 37	37 mm İzoleli Çelik Spiral Boru Telli 37 mm Insulated Steel Spirals Conduit With Guide	25	72,25 ₺
APS - ICST 40	40 mm İzoleli Çelik Spiral Boru Telli 40 mm Insulated Steel Spirals Conduit With Guide	25	78,60 ₺
APS - ICST 42	42 mm İzoleli Çelik Spiral Boru Telli 42 mm Insulated Steel Spirals Conduit With Guide	25	83,90 ₺
APS - ICST 45	45 mm İzoleli Çelik Spiral Boru Telli 45 mm Insulated Steel Spirals Conduit With Guide	25	88,90 ₺
APS - ICST 50	50 mm İzoleli Çelik Spiral Boru Telli 50 mm Insulated Steel Spirals Conduit With Guide	25	116,55 ₺



## ÇELİK SİRALLI BORU STEEL SPIRAL CONDUITS

KOD CODE	ÜRÜN ADI PRODUCT NAME	MT. PACK	FİYAT
APS - CS 9	9 mm Çelik Spiral Boru 9 mm Steel Spirals	50	13,20 ₺
APS - CS 11	11 mm Çelik Spiral Boru 11 mm Steel Spirals	50	14,00 ₺
APS - CS 14	14 mm Çelik Spiral Boru 14 mm Steel Spirals	50	17,00 ₺
APS - CS 16	16 mm Çelik Spiral Boru 16 mm Steel Spirals	50	18,50 ₺
APS - CS 18	18 mm Çelik Spiral Boru 18 mm Steel Spirals	50	20,50 ₺
APS - CS 21	21 mm Çelik Spiral Boru 21 mm Steel Spirals	50	23,30 ₺
APS - CS 26	26 mm Çelik Spiral Boru 26 mm Steel Spirals	25	32,65 ₺
APS - CS 29	29 mm Çelik Spiral Boru 29 mm Steel Spirals	25	34,75 ₺
APS - CS 32	32 mm Çelik Spiral Boru 32 mm Steel Spirals	25	36,52 ₺
APS - CS 37	37 mm Çelik Spiral Boru 37 mm Steel Spirals	25	48,37 ₺
APS - CS 40	40 mm Çelik Spiral Boru 40 mm Steel Spirals	25	56,25 ₺
APS - CS 42	42 mm Çelik Spiral Boru 42 mm Steel Spirals	25	58,75 ₺
APS - CS 45	45 mm Çelik Spiral Boru 45 mm Steel Spirals	25	68,75 ₺
APS - CS 50	50 mm Çelik Spiral Boru 50 mm Steel Spirals	25	78,25 ₺

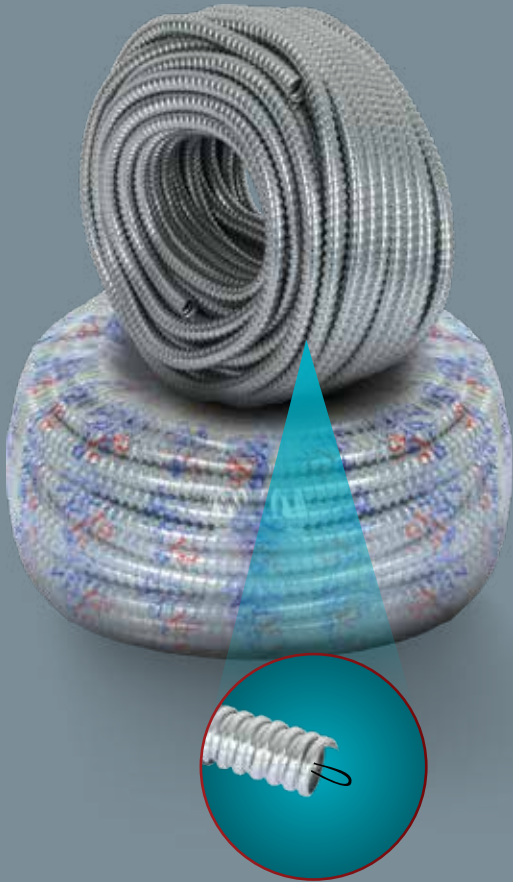

## KILAVUZ TELLİ ÇELİK SİRALLI BORU STEEL SPIRAL CONDUITS WITH GUIDE

KOD CODE	ÜRÜN ADI PRODUCT NAME	MT. PACK	FİYAT
APS - CST 9	9 mm Çelik Spiral Boru Telli 9 mm Steel Spirals Conduit With Guide	50	16,25 ₺
APS - CST 11	11 mm Çelik Spiral Boru Telli 11 mm Steel Spirals Conduit With Guide	50	19,75 ₺
APS - CST 14	14 mm Çelik Spiral Boru Telli 14 mm Steel Spirals Conduit With Guide	50	20,25 ₺
APS - CST 16	16 mm Çelik Spiral Boru Telli 16 mm Steel Spirals Conduit With Guide	50	21,75 ₺
APS - CST 18	18 mm Çelik Spiral Boru Telli 18 mm Steel Spirals Conduit With Guide	50	26,25 ₺
APS - CST 21	21 mm Çelik Spiral Boru Telli 21 mm Steel Spirals Conduit With Guide	50	27,35 ₺
APS - CST 26	26 mm Çelik Spiral Boru Telli 26 mm Steel Spirals Conduit With Guide	25	34,65 ₺
APS - CST 29	29 mm Çelik Spiral Boru Telli 29 mm Steel Spirals Conduit With Guide	25	37,45 ₺
APS - CST 32	32 mm Çelik Spiral Boru Telli 32 mm Steel Spirals Conduit With Guide	25	43,55 ₺
APS - CST 37	37 mm Çelik Spiral Boru Telli 37 mm Steel Spirals Conduit With Guide	25	53,75 ₺
APS - CST 40	40 mm Çelik Spiral Boru Telli 40 mm Steel Spirals Conduit With Guide	25	55,00 ₺
APS - CST 42	42 mm Çelik Spiral Boru Telli 42 mm Steel Spirals Conduit With Guide	25	65,50 ₺
APS - CST 45	45 mm Çelik Spiral Boru Telli 45 mm Steel Spirals Conduit With Guide	25	72,50 ₺
APS - CST 50	50 mm Çelik Spiral Boru Telli 50 mm Steel Spirals Conduit With Guide	25	85,50 ₺

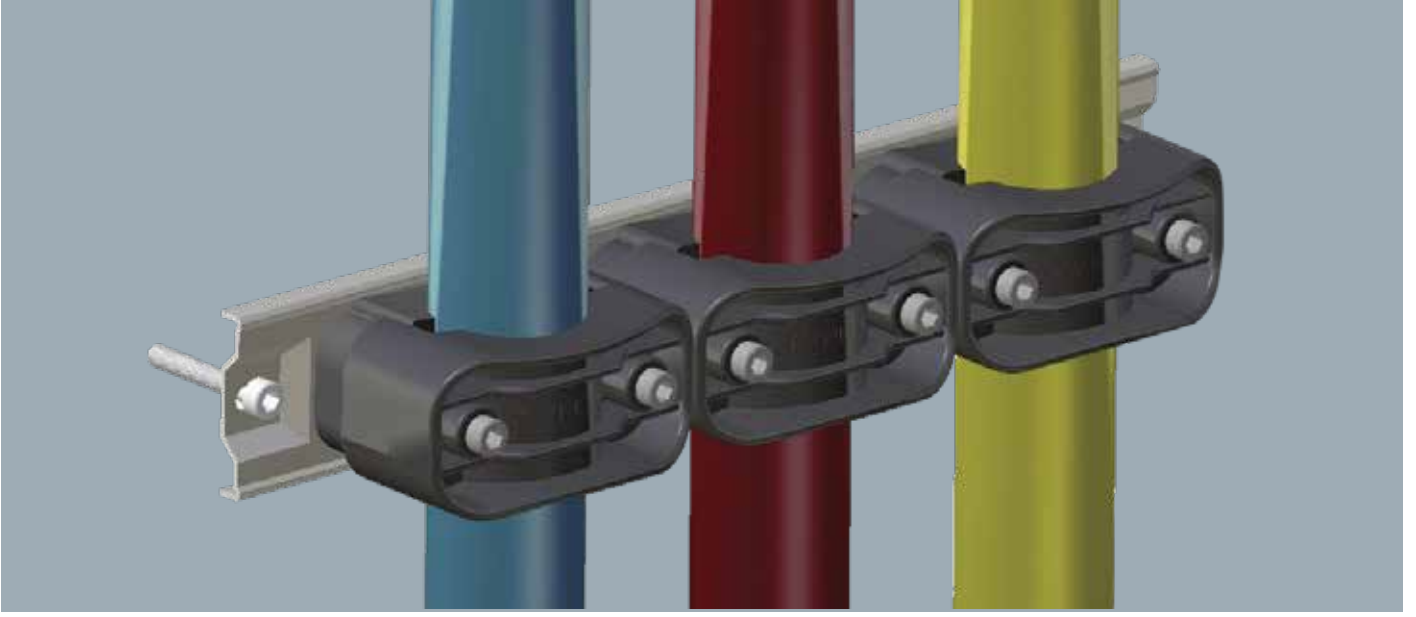

## KABLO KELEPÇESİ - CABLE CLAMP

KOD CODE	ÜRÜN ADI PRODUCT NAME	KABLO ÇAP CABLE DIAMETER	KOLİ AĞIRLIĞI PARCEL HEIGHT	PAKET ADET BOX PCS	FİYAT
<b>TYPE-301</b>	<b>TİP 1 XLPE</b> Kablo Kelepçesi Cable Clamp	30 mm - 42 mm	16	150	46,00 ₺
<b>TYPE-302</b>	<b>TİP 2 XLPE</b> Kablo Kelepçesi Cable Clamp	36 mm - 50 mm	17	100	63,00 ₺
<b>TYPE-303</b>	<b>TİP 3 XLPE</b> Kablo Kelepçesi Cable Clamp	52 mm - 72 mm	16	50	91,00 ₺

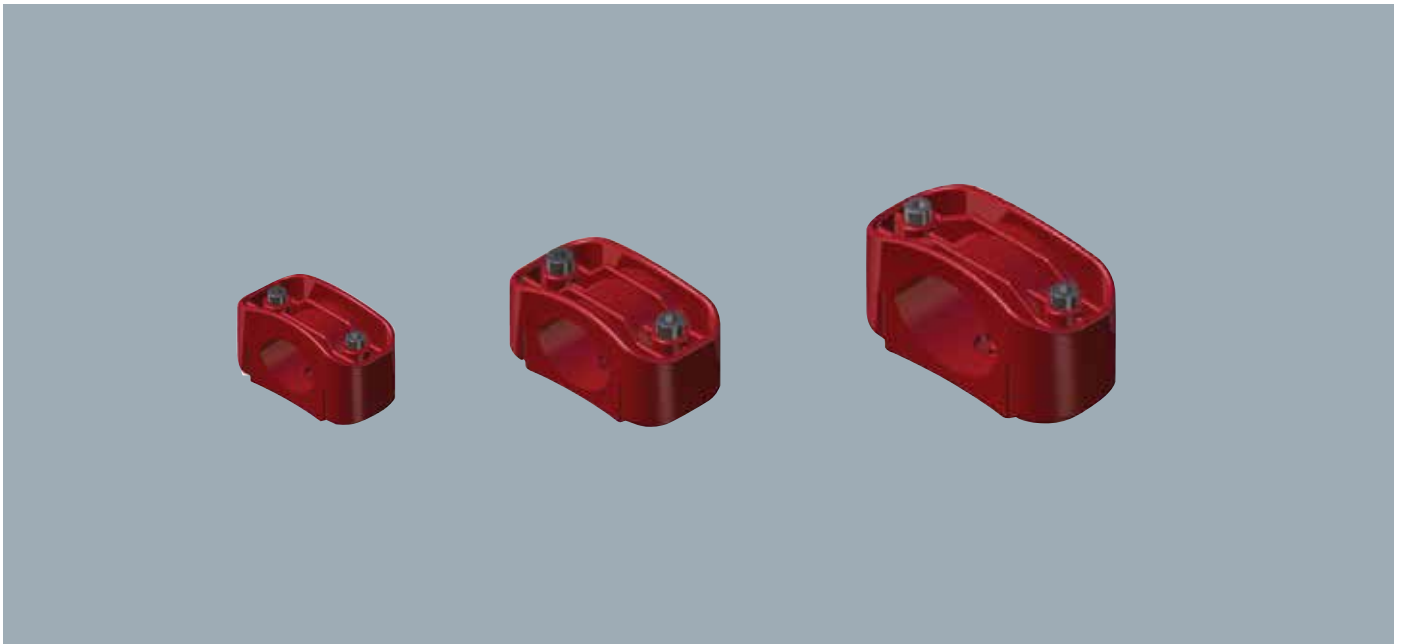

SERTİFİKATA \* ZERTİFİKAT \* CERTIFICATE



**KALİTE YÖNETİMİ**  
**QUALITY MANAGEMENT**

**AK-İŞ PLASTİK PROFİL ELEKTRİK SAN. VE TİC. LTD. ŞTİ.**

IOSB Eski Turgut Özal Cad. D Blok No:8/402 Başakşehir / İstanbul / Türkiye

**PVC KABLO KANALI VE AKSESUARLARI, PVC RİJİT BORULAR, BANYO ASPIRATÖRLERİ, ABS PANO VE TERMOPLASTİK BUAAT, ÇELİK VE İZOLELİ SİRAL BORU İMALATI, PLASTİK KLEMENS, PLASTİK SİRALAR, KABLO BAĞI, KABLO MAKARASI VE SUSTALAR V.B. ELEKTRİK MALZEMELERİ SATIŞI**

**MANUFACTURING OF PVC CABLE TRUNKINGS, ACCESSORIES OF PVC CABLE TRUNKINGS, PVC RIGID CONDUITS, DECORATIVE EXTRACTORS, ABS PANEL BOARDS, THERMOPLASTIC BOXES, STEEL SPIRALS, PVC ISOLATED STEEL SPIRALS AND SALES OF PLASTIC WIRE**

**ISO 9001: 2015**

İlk Yayın Tarihi / Date First Registered : 26.12.2017  
Yayın Tarihi / Date Certificate Issued : 22.12.2021  
Geçerlilik Periyodu / Period of Registration : 13. Yıl / Years  
Geçerlilik Tarihi / Date Certificate Expires : 21.12.2022  
Sertifika Numarası / Certificate No : 0170681705

**IAF** **JAS-ANZ**

**Signature**

**İSHAK ŞİVLİ, General Manager**  
Issued in: **İSTANBUL / TÜRKİYE**

**RoHS DECLARATION OF CONFORMITY**  
**FOLLOWING THE EUROPEAN DIRECTIVE**  
**2011/65/EU RESTRICTION OF THE USE OF CERTAIN HAZARDOUS SUBSTANCES (RoHS)**  
**2011/65/EU BELİRLİ ZARARLI MADDELERİN KULLANIMINI KISITLAMA YÖNETMELİĞİ'NE GÖRE UYGUNLUK BEYANI**

**Manufacturer's Name** AK İŞ PLASTİK PROFİL ELEKTRİK SANAYİ VE TİCARET LİMİTED ŞİRKETİ  
**Üretici** İKİTELLİ ORG. SAN. BÖLG. TURGUT ÖZAL CAD. D BLOK NO:8 K:4/02 BAŞAKŞEHİR / İSTANBUL / TÜRKİYE  
**Manufacturer's address** Üretici adresi  
**Phone** +90 212 671 39 76  
**Tel**  
**Fax** +90 212 671 39 76  
**Faks**  
**Web** www.akisplastik.com.tr  
**E-mail** info@akisplastik.com.tr  
**E-posta**  
**Product description** Cable trunking systems and cable ducting systems for electrical installations  
**Ürün tanımı** Donanımlı kablo kanalı sistemleri ve kablo kanal sistemleri - elektrikli tesisler için

**herewith declare that the products in above are in conformity with the provisions of the following EC Directive when installed in accordance with the installation instructions contained in the product documentation**

**Yukarıda tarif edilen ürünlerimi aşağıda belirtilen Avrupa Topluluğu (AT) tarafından yayınlanmış olan ilgili Avrupa Topluluğu (AT) direktifinin gerekliliklerini karşıladığımı beyan ederiz**

European directive(s) İlgili AT direktif(i)	RESTRICTION OF THE USE OF CERTAIN HAZARDOUS SUBSTANCES (RoHS) (2011/65/EU) BELİRLİ ZARARLI MADDELERİN KULLANIMINI KISITLAMA YÖNETMELİĞİ (2011/65/EU)				
Heavy Metals (RoHS) <sup>1</sup>					
<b>Test Item(s)</b>	<b>Unit</b>	<b>Test Method</b>	<b>Results</b>	<b>MDL</b>	<b>LIMIT</b>
Cadmium (Cd)	mg/kg	With reference to IEC 62281:2008, and performed by ICP-MS	n.d.	2	100
Lead (Pb)	mg/kg	With reference to IEC 62281:2008, and performed by ICP-MS	n.d.	2	1000
Mercury (Hg)	mg/kg	With reference to IEC 62281:2008, and performed by ICP-MS	n.d.	2	1000
Hexavalent Chromium (CrVI)	mg/kg	With reference to IEC 62281:2008, and performed by UV-VIS	n.d.	2	1000

Note: (a) mg/kg + ppm ; 0.1wt% = 1000 ppm  
(b) n.d. = not detected  
(c) MDL = Method Detection Limit

**For and on behalf of the AK İŞ PLASTİK PROFİL ELEKTRİK SANAYİ VE TİCARET LİMİTED ŞİRKETİ;**  
**AK İŞ PLASTİK PROFİL ELEKTRİK SANAYİ VE TİCARET LİMİTED ŞİRKETİ adına;**  
**Signature**  
**İmza**

**İSHAK ŞİVLİ, General Manager**  
Issued in: **İSTANBUL / TÜRKİYE** Issue date: **03 / 07 / 2013**



**EC DECLARATION OF CONFORMITY**  
**FOLLOWING THE EUROPEAN DIRECTIVE**  
**2006/95/EC LOW VOLTAGE EQUIPMENT**  
**2006/95/EC ALÇUK GERİLİM CİHAZ YÖNETMELİĞİ'NE GÖRE UYGUNLUK BEYANI**

**Manufacturer's Name** AK İŞ PLASTİK PROFİL ELEKTRİK SANAYİ VE TİCARET LİMİTED ŞİRKETİ  
**Üretici** İKİTELLİ ORG. SAN. BÖLG. TURGUT ÖZAL CAD. D BLOK NO:8 K:4/02 BAŞAKŞEHİR / İSTANBUL / TÜRKİYE  
**Manufacturer's address** Üretici adresi  
**Phone** +90 212 671 39 76  
**Tel**  
**Fax** +90 212 671 39 76  
**Faks**  
**Web** www.akisplastik.com.tr  
**E-mail** info@akisplastik.com.tr  
**E-posta**  
**Product description** Cable trunking systems and cable ducting systems for electrical installations  
**Ürün tanımı** Donanımlı kablo kanalı sistemleri ve kablo kanal sistemleri - elektrikli tesisler için

**herewith declare that the products in above are in conformity with the provisions of the following essential requirements of EC Directives and standards when installed in accordance with the installation instructions contained in the product documentation**

**Yukarıda tarif edilen ürünlerimi aşağıda belirtilen Avrupa Topluluğu (AT) tarafından yayınlanmış olan ilgili Avrupa Topluluğu (AT) direktiflerinin ve standartlarının gerekliliklerini karşıladığımı beyan ederiz**

European directive(s) İlgili AT direktif(i)	Low Voltage Equipment Directive (2006/95/EC) Alçuk Gerilim Cihazları Yönetmeliği (2006/95/EC)
European standard(s) İlgili AT standartları	EN 50085-1:2005 EN 50085-2-1:2006/AL:2011 EN 50085-2-3:2010

The last two digits of the year in which the CE marking was affixed: 13  
CE işareti ilk kez kullanıldığı yılın son iki rakamı

**For and on behalf of the AK İŞ PLASTİK PROFİL ELEKTRİK SANAYİ VE TİCARET LİMİTED ŞİRKETİ;**  
**AK İŞ PLASTİK PROFİL ELEKTRİK SANAYİ VE TİCARET LİMİTED ŞİRKETİ adına;**  
**Signature**  
**İmza**

**İSHAK ŞİVLİ, General Manager**  
Issued in: **İSTANBUL / TÜRKİYE** Issue date: **05 / 06 / 2013**



**TÜRK STANDARDLARI ENSTİTÜSÜ**  
**TÜRK STANDARDLARINA UYGUNLUK BELGESİ**  
**TURKISH STANDARDS INSTITUTION**  
**CERTIFICATE OF CONFORMITY TO TURKISH STANDARDS**

**Belge Numarası** 130124-TSE-03/13  
**Belgenin İlk Veriliş Tarihi** 04/07/2013  
**Belgenin Son Geçerlilik Tarihi** 04/07/2023  
**Belge Sahibi Kuruluşun Adı** AK İŞ PLASTİK PROFİL ELEKTRİK SANAYİ VE TİCARET LİMİTED ŞİRKETİ  
**Belge Sahibi Kuruluşun Adresi** İKİTELLİ ORG. SAN. BÖLG. TURGUT ÖZAL CAD. D BLOK NO:8 K:4/02 BAŞAKŞEHİR / İSTANBUL / TÜRKİYE  
**Üretim Yeri Adı** AK İŞ PLASTİK PROFİL ELEKTRİK SAN. VE TİC. LTD. ŞTİ.  
**Üretim Yeri Adresi** İO S B ESKİ TURGUT ÖZAL CAD. ALTINTAÇ İŞ MERKEZİ NO:8 D BLOK: 8/402 BAŞAKŞEHİR / İSTANBUL / TÜRKİYE

**İPTAL EDİLEN BELGE NUMARASI (Varse)** AK İŞ PLASTİK PROFİL ELEKTRİK SANAYİ VE TİCARET LİMİTED ŞİRKETİ  
**TESLİMİ TİCARİ MARKASI** AK İŞ PLASTİK PROFİL ELEKTRİK SANAYİ VE TİCARET LİMİTED ŞİRKETİ  
**İLİMLİ TÜRK STANDARTI** TS EN 50085-2-3 / 13 01 2011  
**BELGE KAPSAMI** ALÇUK GERİLİM CİHAZLARI

**DUYAR VE TAVANLARA VERİLEŞTİRİLMİŞ İÇİN TASARLANMIŞ DÜZ YATAY KABLO KANALI SİSTEMLERİ (KDS-CYS)**  
C İSİ ÇALIŞILAN DÜZ YATAY KABLO KANALI SİSTEMLERİ  
MODE: J-APGG XX0XX, APSMB XX0XX, ACSB XX0XX  
BEYAN ÖĞELERİ: 25x25, 25x40, 25x60, 40x40, 40x60, 40x80, 60x60, 60x80, 80x60, 80x80  
MALZEMESİNE GÖRE METALLİK DÜLMİYAN, DARRİYE DAYANIMLIK UYGUNLUK BELGESİ  
SICAKLIK BEYANI  
-EN DÜŞÜK DEĞİRLERİ VE NAKL SİCARL K BEYANI- 75°C  
-EN DÜŞÜK TEBİS VE UYGULAMA SİCARL K BEYANI- İYUĞLANMAZ.

**İmza**  
07.02.2022  
Belge Sahibi Kuruluşunun Adına  
İSHAK ŞİVLİ  
TSE İSTANBUL BELGELENDİRME MÜDÜRÜ





**TÜRK STANDARLARI ENSTİTÜSÜ**  
TÜRK STANDARLARINA UYGUNLUK BELGESİ  
**TURKISH STANDARDS INSTITUTION**  
CERTIFICATE OF CONFORMITY TO TURKISH STANDARDS

Numara / No : 07.02.2022  
TSE

BELGE KAPSAMI (130124-TSE-0202) (nolu belge devamı) : AK İŞ PLASTİK PROFİL ELEKTRİK SANAYİ VE TİCARET LİMİTED ŞİRKETİ  
İLGİLİ TÜRK STANDARTI(RELATED TURKISH STANDARD) : TS EN 50385-2-1 : 19 36 2701

EN YÜKSEK ÜYÜŞÜ ANA SICAKLIK BEYANI : +90 °C  
ALEV YAYILMASINA KARŞI DAYANIKLILIK : ALEV YAYIMAYAN,  
ELEKTRİKSEL SÜRÜKLÜK ÖZELLİĞİNE GÖRE UYGULANMAZ,  
ELEKTRİKSEL YALITIM ÖZELLİĞİNE GÖRE UYGULANMAZ,  
EN 50385 : 1991'E GÖRE MAHFAZA TARAFINDAN SAĞLANAN KORUMA DÜZEĞİNE GÖRE UYGULANMAZ  
KORUZU VEYA KIRILTIÇİ MADDELERE KARŞI KORUMA İÇİ TARAFI VE DİŞ TARAFI DÜŞÜK KÖRÜMALİ  
SİSTEMERİN KAPADININ GÜVENLİLİĞİNE GÖRE UYGULANMAZ,  
ELEKTRİKSEL OLARAK KORULUCU AYIRIMAYA GÖRE UYGULANMAZ  
AMAKLANAN TEŞİŞ KÖRÜMLERİNE GÖRE KAPAKIN İNŞAĞI KÖRÜMLÜ HARIÇ OLMAK ÜZERE DÜŞEY VEYA YATAY YÜZEY ÜZERİNE MONTE EDİLMEŞİ

07.02.2022

Belgelendirme Merkezi Başkanı Adına  
AHMET NURSU KARTAL

TSE İSTANBUL BELGELENDİRME MÜDÜRÜ

Belge geçerliliği için belgeyi Belgeleştirme Merkezi'nin internet sitesinde yayımlanan QR kodunu okuyunuz.  
The validity of the certificate is confirmed by scanning the QR code published on the website of the TSE.



http://www.tse.gov.tr/eng/Belgelestirme/BelgelestirmeBelgesi.aspx?BelgeNo=130124-TSE-0202

TEST REPORT IEC 60335-1 HOUSEHOLD AND SIMILAR ELECTRICAL APPLIANCES – SAFETY – Part 1: General requirements	
Report Number.....	TR_2022198_1
Date of Issue.....	2022 March 29
Total number of pages.....	114
Applicant's name.....	EİK Sertifikasyon Uluslararası Belgelendirme Gözetim Kontrol Denetim Hizmetleri A.Ş.
Address.....	Yenişehir Mah. Reyhan Cad. Tanay Konakları A-22 No: 30/22 İç Kapı No: 1 Pendik/İstanbul/Türkiye
<b>Test specification:</b>	
Standard.....	IEC 60335-1:2020
Test procedure.....	Test Report
Non-standard test method.....	N/A
Test Report Form No.....	IEC60335_1Z
Test Report Form(s) Originator.....	TÜV SÜD Product Service GmbH
Master TRF.....	Dated 2020-12-10
Test item description.....	Bathroom Ventilation Fan
Trade Mark.....	Ak İş Plastik Profil. Elek. San. Tic. Ltd. Şti
Manufacturer.....	Ak İş Plastik Profil. Elek. San. Tic. Ltd. Şti
Model/Type reference.....	See the page 5
Ratings.....	See the page 5
Testing location/ address.....	SGS Turkey E&E Laboratory / Bağlar Mah. Osmanpaşa Cad. No: 95 Is Istanbul Plaza E Giriş 34209 Gunesli Istanbul Turkey
Tested by (name + signature).....	Özer Gülmez
Approved by (name + signature).....	Mahmut Aksakallı



Disclaimer: This document is controlled and has been released electronically.  
Only the version on the IEC60335 Website is the current document version



**TÜRK STANDARLARI ENSTİTÜSÜ**  
TÜRK STANDARLARINA UYGUNLUK BELGESİ  
**TURKISH STANDARDS INSTITUTION**  
CERTIFICATE OF CONFORMITY TO TURKISH STANDARDS

Numara / No : 07.02.2022  
TSE

BELGE NUMARASI  
REFERENCE NUMBER (OF DOCUMENT) : 130124-TSE-02-02

BELGENİN İLK VERİLİŞ TARİHİ  
DATE OF FIRST ISSUE OF CERTIFICATE : 04.02.2022

BELGENİN SON GEÇERLİLİK TARİHİ  
CERTIFICATE VALIDITY DATE : 04.02.2023

BELGE SAHİBİ KURULUŞUN ADI  
NAME OF THE LICENSEE / HOLDER : AK İŞ PLASTİK PROFİL, ELEKTRİK SANAYİ VE TİCARET LİMİTED ŞİRKETİ

BELGE SAHİBİ KURULUŞUN ADRESİ  
ADDRESS OF THE LICENSEE / HOLDER : İZMİT LİNE SAN. BÖLGE, TÜRKİYE ÖZAL CD.D BLOK K.1-402 NO.8 BAŞAKŞEHİR İSTANBUL/TÜRKİYE

ÜRETİM YERİ ADI  
NAME OF THE MANUFACTURING PLACE : AK İŞ PLASTİK PROFİL ELEKTRİK SAN. VE TİCARET ŞTİ

ÖRETİM YERİ ADRESİ  
ADDRESS OF THE MANUFACTURING PLACE : İ.O.S.B.İSK. TÜRKİYE ÖZAL CAD. ALT. NİTAÇ İŞ MERKEZİ NO 8 / O BLOK 4/402 BAŞAKŞEHİR İTİS FANBUL İSTANBUL / TÜRKİYE

İPTAL EDİLEN BELGE NUMARASI (Var ise)  
INVALID FORM OF SUPPLEMENTED LICENSE (if any) : 130124-TSE-02-01

TESCİLLİ TİCARİ MARKASI  
REGISTERED TRADE MARK : AK İŞ AĞS ANİSİNA PROFİL ELEKTRİK SAN. VE TİC. ŞTİ ŞİRKETİ

İLGİLİ TÜRK STANDARTI(RELATED TURKISH STANDARD)  
TS EN 50385-2-1 : 19 36 2701

07.02.2022

Belgelendirme Merkezi Başkanı Adına  
AHMET NURSU KARTAL

TSE İSTANBUL BELGELENDİRME MÜDÜRÜ

Belge geçerliliği için belgeyi Belgeleştirme Merkezi'nin internet sitesinde yayımlanan QR kodunu okuyunuz.  
The validity of the certificate is confirmed by scanning the QR code published on the website of the TSE.



http://www.tse.gov.tr/eng/Belgelestirme/BelgelestirmeBelgesi.aspx?BelgeNo=130124-TSE-0202



**TÜRK STANDARLARI ENSTİTÜSÜ**  
TÜRK STANDARLARINA UYGUNLUK BELGESİ  
**TURKISH STANDARDS INSTITUTION**  
CERTIFICATE OF CONFORMITY TO TURKISH STANDARDS

Numara / No : 07.02.2022  
TSE

BELGE KAPSAMI (130124-TSE-0202) (nolu belge devamı) : AK İŞ PLASTİK PROFİL ELEKTRİK SANAYİ VE TİCARET LİMİTED ŞİRKETİ  
İLGİLİ TÜRK STANDARTI(RELATED TURKISH STANDARD) : TS EN 50385-2-1 : 19 36 2701

(17x60 T BAĞLANTISI) L BAĞLANTISI İÇİ KOŞUĞU İÇİ KOŞUĞU SONLANDIRILMA ÜÇÜLÜ TEŞİŞ VE UYGULAMA İÇİN DARBEME KARŞI DAYANIKLILIK 2.1.

DİĞER ÖZELLİKLERİ  
YALIZEME TİPİ: METALİK OLMAYAN  
SICAKLIK BEYANI  
EN YÜKSEK ÜYÜŞÜ ANA VE MAKUL SICAKLIK BEYANI : +70 °C  
-EN DÜŞÜK TEŞİŞ VE UYGULAMA SICAKLIK BEYANI : +15 °C  
-FN YÜKSEK UYGULAMA SICAKLIK BEYANI : +60°C  
ALEV YAYILMASINA KARŞI DAYANIKLILIK : ALEV YAYIMAYAN,  
ELEKTRİKSEL SÜRÜKLÜK ÖZELLİĞİNE GÖRE UYGULANMAZ,  
ELEKTRİKSEL YALITIM ÖZELLİĞİNE GÖRE UYGULANMAZ,  
EN 50385 : 1991'E GÖRE MAHFAZA TARAFINDAN SAĞLANAN KORUMA DÜZEĞİNE GÖRE UYGULANMAZ  
KORUZU VEYA KIRILTIÇİ MADDELERE KARŞI KORUMA İÇİ TARAFI VE DİŞ TARAFI DÜŞÜK KÖRÜMALİ  
SİSTEMERİN KAPADININ GÜVENLİLİĞİNE GÖRE UYGULANMAZ,  
ELEKTRİKSEL OLARAK KORULUCU AYIRIMAYA GÖRE DAHLİ KORULUCU BÖLMESİ OLMAYAN  
AMAKLANAN TEŞİŞ KÖRÜMLERİNE GÖRE DUVARDA VE TAVANDA NÜZUYE MONTE EDİLEN VEYA YARI SIVA ALTI,  
DÜŞÜK YALITIM İZOLASYON VE KENAR KONJUNGUNDA TS-009 NİN MONTE EDİLMESİ DURUMUNDA SIVALAR YALITIMLI ELEKTRİKLER VE ENERJİ BİLGİLERİNE AĞS-NDAKİ TEMASIN ÖNLENMESİNE GÖRE REVAK EDİLMEMİŞ  
TİPİ: SİP T P 2  
GDS'İN SİGİRTİRMA DAYANIKLILIĞINA GÖRE UYGULANMAZ

07.02.2022

Belgelendirme Merkezi Başkanı Adına  
AHMET NURSU KARTAL

TSE İSTANBUL BELGELENDİRME MÜDÜRÜ

Belge geçerliliği için belgeyi Belgeleştirme Merkezi'nin internet sitesinde yayımlanan QR kodunu okuyunuz.  
The validity of the certificate is confirmed by scanning the QR code published on the website of the TSE.



http://www.tse.gov.tr/eng/Belgelestirme/BelgelestirmeBelgesi.aspx?BelgeNo=130124-TSE-0202





ELECTRICAL MATERIALS



# AKIS

PLASTIC

### Fabrika - Ofis

İkitelli OSB Atatürk Bulvarı.  
No:104 Kat:5  
İkitelli - Başakşehir / İSTANBUL / TÜRKİYE

+90 212 671 44 71

+90 212 671 44 28

planlama@akisplastik.com.tr

export@akisplastik.com.tr

www.akisplastik.com.tr

### Merkez (Satış Destek)

SEDA KURU

+90 535 206 28 66

### İstanbul Bölge Satış Yöneticisi

ERSİN TANÖREN

+90 539 650 57 41

### Marmara & Ege & Akdeniz Bölge Satış Yöneticisi

HAKAN AKIN

+90 539 575 55 90

### Karadeniz Bölge Satış Yöneticisi

NEVZAT ATABEY

+90 539 300 04 60

### İç Anadolu & Doğu ve Güney Doğu Anadolu Bölge Satış Yöneticisi

CENGİZ ARDIÇ

+90 531 991 66 03