

ELECTRICAL MATERIALS



# AKIS

PLASTIC



ÜRÜN  
KATALOĞU

PRODUCT  
CATALOGUE



ELECTRICAL MATERIALS

# AKIS

---

P L A S T I C





# işin özü kalite...



# HAKKIMIZDA - ABOUT US



Firmamız 2012 yılında İstanbul'da kurulmuştur. 4500mt<sup>2</sup> kapalı alanda pvc kablo kanalı ve elektrik malzemeleri üretimi yapmaktadır. Yıllık 25.000.000 mt kablo kanalı üretim kapasitesi ile kaliteden hiçbir şekilde ödün vermeden siz değerli iş ortaklarımızla daha büyük hedeflere ilerlemektedir. Otuz yıllık bilgi birikimi ve deneyimlerimize güvenerek siz değerli müşterilerimize hizmet vermekten gurur duyuyoruz.

Globalleşen dünyada bir adım öne çıkmanın yolu istikrarlı çalışmak daha kaliteli ürün ve hizmet vermekten geçmekte olduğunun bilincindeyiz. Daimi sloganımız ve nihayi hedefimiz siz değerli müşterilerimizin memnuniyetidir.

Our company was built in 2012 in İstanbul. Our factory is with an area of 4500m<sup>2</sup> specialized in the production cable trunkings products and the manufacture of electrical material. The annual production of the cable tray exceeds 25,000,000 meters With our experience and knowledge of business more than 30 years in this field we envision achieving impressive results with you.

We have all the pleasure to offer you our services honorable clients. We work every day with perseverance and stability for our society to be open development day after day. Our motto and our ultimate goal is the satisfaction of our customers.

Notre société a été construite en 2012 à İstanbul . Notre usine est d'une surface de 2500 m2 spécialisée dans la production des chemins de cables et les produits électriques ainsi que la fabrication des matériaux électriques. La production annuelle des chemins de cables dépassent Les 20.000.000 mètres Avec notre expérience et notre connaissance de métier de plus que 30 ans dans ce domaine . Nous envisageons la réalisation de résultats impressionnants avec vous .

On a tout le plaisir de vous proposer nos services. honorables clients . Nous travaillons chaque jour avec persévérance et stabilité pour que notre société soit en plein développement jour après jour . Notre devise et notre ultime objectif est la satisfaction de nos clients.

تأسست شركتنا سنة 2012 في مدينة إسطنبول والمساحة المغطاة للمصنع هي 2500 متر مربع متخصصة في إنتاج قنوات الكابل والمواد الكهربائية

كما ننتج سنويا 20.000.000 متر من قنوات الكابل.

نحن نتقدم معكم الى أكبر الأهداف، ثلاثون سنة من الخبرة والمعرفة كما نعتمد على تجربتنا ونحن نتفخر لخدمتكم انتم زبائننا الكرام

نحن نعمل بجهد وباستقرار لكي تكون شركتنا في تطور سريع يوم بعد يوم.

شعارنا وهدفنا النهائي هو إرضاء عملائنا.



# İÇERİK - INDEX

<b>KAPALI TİP KABLO KANALLARI - CLOSED TYPE CABLE TRUNKINGS</b>	<b>01 - 08</b>
<b>İÇTEN KAPAKLI KABLO KANALI VE AKSESUARLARI - INSIDE COVER CABLE TRUNKING AND ACCESSORIES</b>	<b>09</b>
<b>MONTAJ TAMAMLAMA AKSESUARLARI - ASSEMBLY ACCESSORIES</b>	<b>10</b>
<b>YAPIŞKAN BANTLI KABLO KANALLARI - SELF ADHESIVE CABLE TRUNKINGS</b>	<b>11</b>
<b>ZEMİN ÜSTÜ (BALIK SIRTİ) PVC KABLO KANALLARI GRİ - OVERFLOOR PVC CABLE TRUNKINGS GREY</b>	<b>12</b>
<b>DELİKLİ (PANO TİPİ) PVC KABLO KANALLARI GRİ - PVC SLOTTED CABLE TRUNKINGS GREY</b>	<b>13 - 16</b>
<b>DELİKLİ (PANO TİPİ) PVC KABLO KANALLARI BEYAZ - PVC SLOTTED CABLE TRUNKINGS WHITE</b>	<b>17 - 18</b>
<b>AKSESUARLAR - ACCESSORIES</b>	<b>19</b>
<b>DÜBEL TÜRLERİ - DOWEL TYPES</b>	<b>20</b>
<b>ASPIRATÖR - ASPIRATORS</b>	<b>21 - 22</b>
<b>ABS PANO - ABS BOARD</b>	<b>23 - 28</b>
<b>MENHOL - UNDERGROUND BOARD</b>	<b>29 - 30</b>
<b>SİGORTA KUTULARI - FUSE BOXES</b>	<b>31 - 34</b>
<b>SUSTALAR - SPRINGS</b>	<b>35</b>
<b>SIKMALI TİP KABLO PABUÇU - CABLE LUGS</b>	<b>36</b>
<b>KOFRALAR VE POSTA KUTUSU - ELECTRICAL BOXES AND THERMINALS</b>	<b>37</b>
<b>DÖŞEME ALTI BUATLAR VE PRİZ KUTULARI - FIXING CABLO LUG</b>	<b>38</b>
<b>KAUÇUK PRİZLER - RUBBER SOCKETS</b>	<b>39 - 40</b>
<b>BUAT KUTULARI - BOX BOXES</b>	<b>41 - 44</b>
<b>KABLO MAKARALARI - CABLE REELS</b>	<b>45 - 46</b>
<b>CEE NORM FİŞ PRİZLER - CEE NORM PLUG SOCKETS</b>	<b>47 - 54</b>
<b>BORULAR - CONDUITS</b>	<b>55 - 57</b>
<b>BORU BAĞLANTI AKSESUARLARI - PIPE CONNECTION ACCESSORIES</b>	<b>58</b>
<b>SPİRAL BORULAR - SPIRALS CONDUITS</b>	<b>59 - 64</b>
<b>KANGAL BORULAR - COIL PIPES</b>	<b>65 - 66</b>
<b>UNITECH VERİ İLETİŞİM KABLOLARI - DATA TRANSMISSION CABLES</b>	<b>67 - 68</b>
<b>GÜVENLİK VE KAMERA KABLOLARI - SECURITY AND CAMERA CABLES</b>	<b>69 - 70</b>
<b>KLEMENS GRUBU - CONNECTORS GROUP</b>	<b>71 - 72</b>
<b>KASA VE BUATLAR - CASING AND JUNCTION BOXES</b>	<b>73 - 74</b>
<b>KABLO BAĞLARI VE KROŞELER - CABLE TIES AND STRAPS</b>	<b>75 - 76</b>
<b>ELEKTRİK SAYAÇLARI - ELECTRONİC METERS</b>	<b>77 - 78</b>
<b>ARMATÜR SERİSİ - ARMATURE SERIES</b>	<b>79 - 88</b>
<b>AĞIR HİZMET TİP KABLO KANALLARI - HEAVY DUTY CABLE TRAYS</b>	<b>89 - 94</b>
<b>PG &amp; HDG KABLO MERDİVENLERİ - PG &amp; HDG CABLE LADDER</b>	<b>95 - 98</b>
<b>TEL ÖRGÜ KABLO KANALLARI - WIREMESH CABLE TRAYS</b>	<b>99 - 100</b>
<b>KABLO KANALI VE KAPAKLAR - CABLE TRAY AND COVERS</b>	<b>101 - 102</b>
<b>DESTEK VE TAŞIMA SİSTEMLERİ - SUPPORTING SYSTEMS</b>	<b>102 - 107</b>
<b>SERTİFİKALAR - CERTIFICATES</b>	<b>108 - 109</b>



**Mekanik Darbelere dayanıklı.**  
Resistance to mechanical  
shock hits 2 Joule



**Topraklama gerekmez.**  
No need for grounding



Alev aldığıında kendiliğinden sönebilen katkı maddeli PVC malzeme (UL94V0 M1).  
Self extinguishing PVC fire reaction (UL94V0 M1)

## Kapalı tip kablo kanallarımızın teknik özellikleri

Technical specifications for closed type cable trunkings

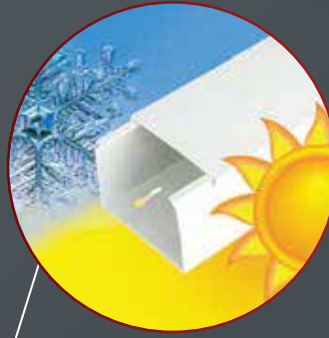

Ultraviyole ışıklara dayanıklı (UV).  
Resistance to ultraviolet lights (UV)



Boyanabilir.  
Paintable



İstenilen boyutta kesilebilir.  
Cut down to required size







**12 x 12**

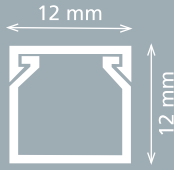

Ürün Kodu - Product Code

**APSK - 12012 Kutulu**

Kutu - Box

Paket / Metre - Package / Meter

320 mt

**APSN - 12012 Naylon Amb.**

Naylon / Nylon

Paket / Metre - Package / Meter

200 mt



**15 x 10**

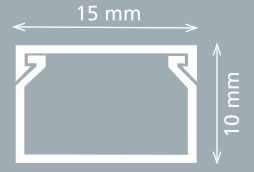

Ürün Kodu - Product Code

**APSK - 15010 Kutulu**

Kutu - Box

Paket / Metre - Package / Meter

300 mt

**APSN - 15010 Naylon Amb.**

Naylon / Nylon

Paket / Metre - Package / Meter

200 mt



**16 x 16**

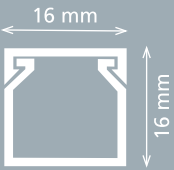

Ürün Kodu - Product Code

**APSK - 16016 Kutulu**

Kutu - Box

Paket / Metre - Package / Meter

180 mt

**APSN - 16016 Naylon Amb.**

Naylon / Nylon

Paket / Metre - Package / Meter

100 mt



**20 x 10**

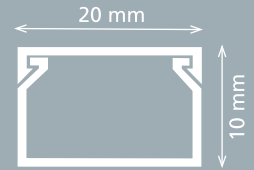

Ürün Kodu - Product Code

**APSK - 20010 Kutulu**

Kutu - Box

Paket / Metre - Package / Meter

240 mt

**APSN - 20010 Naylon Amb.**

Naylon / Nylon

Paket / Metre - Package / Meter

200 mt

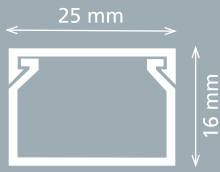
**25 x 16**

Ürün Kodu - Product Code

**APSK - 25016 Kutulu**

Kutu - Box

Paket / Metre - Package / Meter

154 mt

**APSN - 25016 Naylon Amb.**

Naylon / Nylon

Paket / Metre - Package / Meter

100 mt

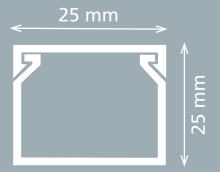
**25 x 25**

Ürün Kodu - Product Code

**APSK - 25025 Kutulu**

Kutu - Box

Paket / Metre - Package / Meter

96 mt

**APSN - 25025 Naylon Amb.**

Naylon / Nylon

Paket / Metre - Package / Meter

50 mt

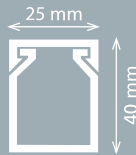
**25 x 40**

Ürün Kodu - Product Code

**APSK - 25040 Kutulu**

Kutu - Box

Paket / Metre - Package / Meter

80 mt

**APSN - 25040 Naylon Amb.**

Naylon / Nylon

Paket / Metre - Package / Meter

100 mt

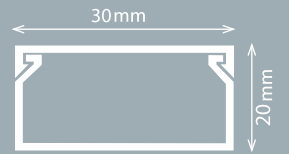
**30 x 20**

Ürün Kodu - Product Code

**APSK - 30020 Kutulu**

Kutu - Box

Paket / Metre - Package / Meter

100 mt

**APSN - 30020 Naylon Amb.**

Naylon / Nylon

Paket / Metre - Package / Meter

50 mt



**40 x 16**

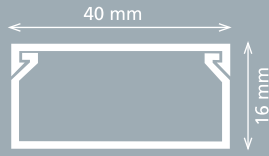

Ürün Kodu - Product Code

**APSK - 40016 Kutulu**

Kutu - Box

Paket / Metre - Package / Meter

84 mt

**APSN - 40016 Naylon Amb.**

Naylon / Nylon

Paket / Metre - Package / Meter

50 mt



**40 x 25**

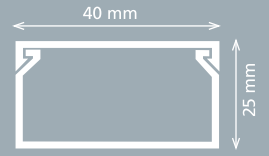

Ürün Kodu - Product Code

**APSK - 40025 Kutulu**

Kutu - Box

Paket / Metre - Package / Meter

80 mt

**APSN - 40025 Naylon Amb.**

Naylon / Nylon

Paket / Metre - Package / Meter

50 mt



**40 x 40**

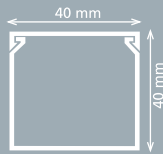

Ürün Kodu - Product Code

**APSK - 40040 Kutulu**

Kutu - Box

Paket / Metre - Package / Meter

72 mt

**APSN - 40040 Naylon Amb.**

Naylon / Nylon

Paket / Metre - Package / Meter

48 mt



**50 x 50**

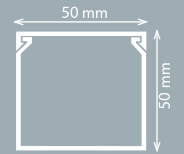

Ürün Kodu - Product Code

**APSK - 50050 Kutulu**

Kutu - Box

Paket / Metre - Package / Meter

48 mt

**APSN - 50050 Naylon Amb.**

Naylon / Nylon

Paket / Metre - Package / Meter

32 mt

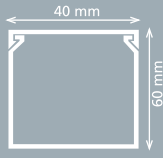

**40 X 60**

Ürün Kodu - Product Code

**APSK - 40060 Kutulu**

Kutu - Box

Paket / Metre - Package / Meter

48 mt

**APSN - 40060 Naylon Amb.**

Naylon / Nylon

Paket / Metre - Package / Meter

30 mt

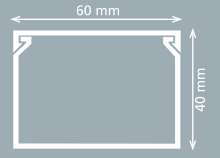
**60 x 40**

Ürün Kodu - Product Code

**APSK - 60040 Kutulu**

Kutu - Box

Paket / Metre - Package / Meter

48 mt

**APSN - 60040 Naylon Amb.**

Naylon / Nylon

Paket / Metre - Package / Meter

30 mt

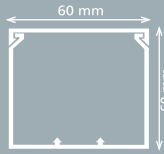
**60 x 60**

Ürün Kodu - Product Code

**APSK - 60060 Kutulu**

Kutu - Box

Paket / Metre - Package / Meter

40 mt

**APSN - 60060 Naylon Amb.**

Naylon / Nylon

Paket / Metre - Package / Meter

32 mt

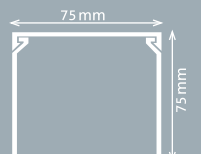
**YENİ ÜRÜN**  
NEW PRODUCT**75 x 75**

Ürün Kodu - Product Code

**APSK - 75075 Kutulu**

Kutu - Box

Paket / Metre - Package / Meter

24 mt

**APSN - 75075 Naylon Amb.**

Naylon / Nylon

Paket / Metre - Package / Meter

16 mt



**80 x 40**

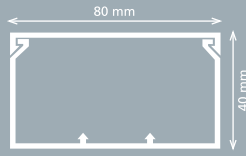

Ürün Kodu - Product Code

**APSK - 80040 Kutulu**

Kutu - Box

Paket / Metre - Package / Meter

36 mt

**APSN - 80040 Naylon Amb.**

Naylon / Nylon

Paket / Metre - Package / Meter

24 mt



**80 x 60**

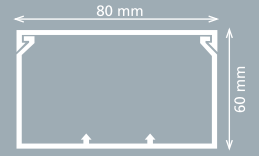

Ürün Kodu - Product Code

**APSK - 80060 Kutulu**

Kutu - Box

Paket / Metre - Package / Meter

32 mt

**APSN - 80060 Naylon Amb.**

Naylon / Nylon

Paket / Metre - Package / Meter

24 mt



**100 x 100**

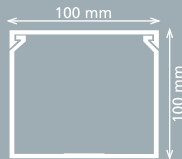

Ürün Kodu - Product Code

**APSK - 100100 Kutulu**

Kutu - Box

Paket / Metre - Package / Meter

16 mt

**APSN - 100100 Naylon Amb.**

Naylon / Nylon

Paket / Metre - Package / Meter

12 mt



**100 x 40**

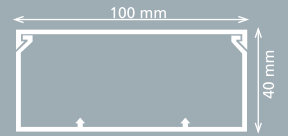

Ürün Kodu - Product Code

**APSK - 100040 Kutulu**

Kutu - Box

Paket / Metre - Package / Meter

28 mt

**APSN - 100040 Naylon Amb.**

Naylon / Nylon

Paket / Metre - Package / Meter

16 mt

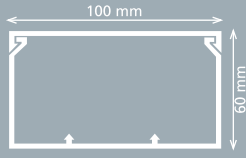
**100 x 60**

Ürün Kodu - Product Code

**APSK - 100060 Kutulu**

Kutu - Box

Paket / Metre - Package / Meter

24 mt

**APSN - 100060 Naylon Amb.**

Naylon / Nylon

Paket / Metre - Package / Meter

16 mt

**YENİ ÜRÜN  
NEW PRODUCT**

Ara bölme takılabilir - Partition can be attached

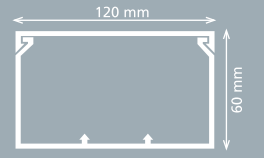
**120 x 60**

Ürün Kodu - Product Code

**APSK - 120060 Kutulu**

Kutu - Box

Paket / Metre - Package / Meter

20 mt

**APSN - 120060 Naylon Amb.**

Naylon / Nylon

Paket / Metre - Package / Meter

12 mt





**100 x 50**

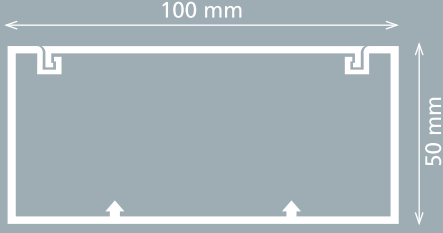

Ürün Kodu - Product Code

**APSK - 100050**

Uzunluk - Length	2m
Kesit - Section	100 x 50
Ambalaj Miktarı (m) - Package Total (m)	16 Mt.
Ambalaj Şekli - Package	Koli - Carton Box

3 ara bölme takılabilir - Up to 3 divider possibility



TSE 130124-TSE-02/02

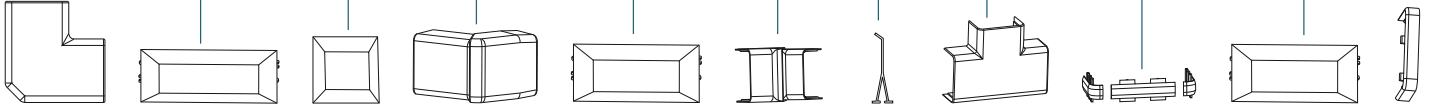
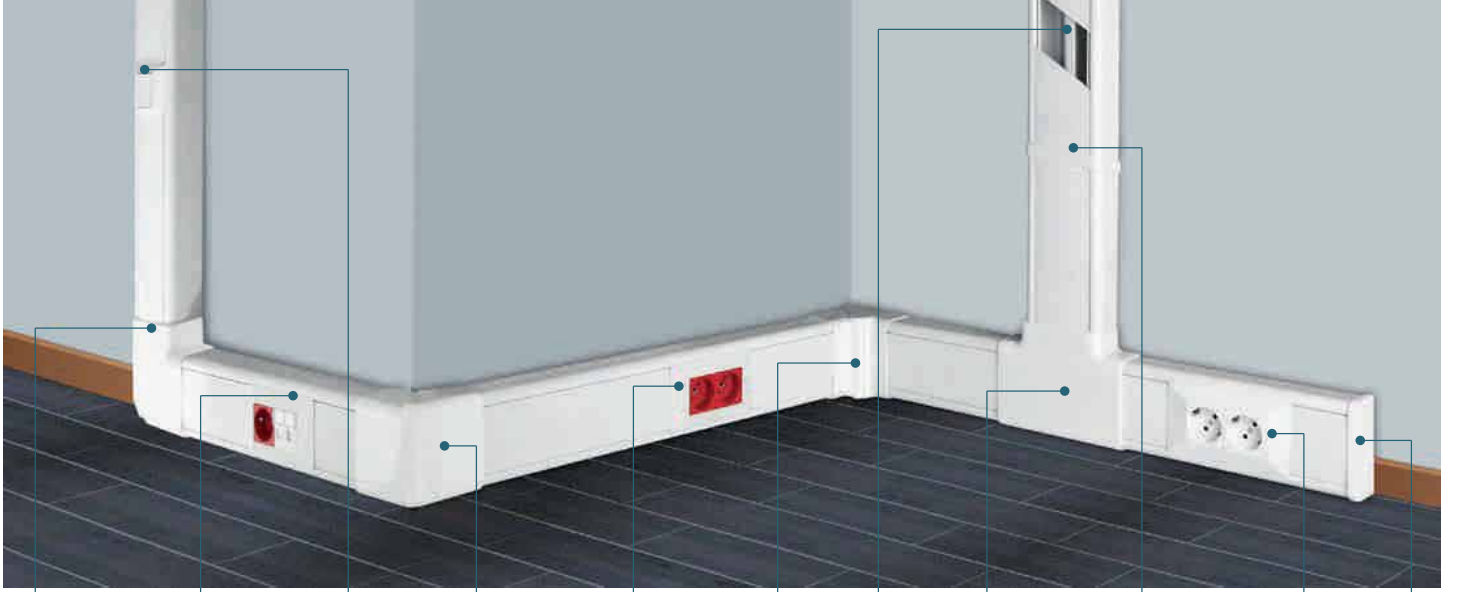

**AP-150T**

T Bağlantı Elemanı  
T Branches  
Kutu: 12 Adet  
Box: 12 Pcs.

**AP-150P**

Sonlandırma Kapağı  
End Cover  
Kutu: 24 Adet  
Box: 24 Pcs.

**AP-150KB**

Kanal Birleştirme Parçası  
Junction Piece  
Kutu: 24 Adet  
Box: 24 Pcs.

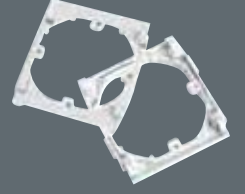
**AP-150 TP**

Tekli 80 x 80 Priz Montaj Seti  
Single Frame Cover Set For 80 x 80  
Kutu: 12 Adet  
Box: 12 Pcs.

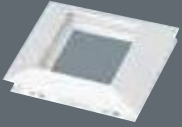
**AP-150T45**

İkili 45 x 45 Priz Montaj Seti  
Single Frame Cover Set For 45 x 45  
Kutu: 12 Adet  
Box: 12 Pcs.

**AP-150L45**

İkili 45 x 45 Priz Montaj Seti  
Double Frame Cover Set For 45 x 45  
Kutu: 12 Adet  
Box: 12 Pcs.

**AP-150U45**

Üçlü 45 x 45 Priz Montaj Seti  
Triple Frame Cover Set For 45 x 45  
Kutu: 12 Adet  
Box: 12 Pcs.

**AP-150D45**

Dörtlü 45 x 45 Priz Montaj Seti  
Quadruple Frame Cover Set For 45 x 45  
Kutu: 20 Adet  
Box: 20 Pcs.

**AP-110T**

İngiliz Tip Tekli Priz Çerçevesi  
British Type Socket Frame  
Kutu: 100  
Box: 100

**AP-111T**

İngiliz Tip İkili Priz Çerçevesi  
British Type Double Socket Frame  
Kutu: 100  
Box: 100

**AP-150FP02**

45x45 Data ve Telefon Priz Kapağı Tekli  
45x45 Data and Telephone Socket Single  
Kutu : 10 adet  
Box : 100 Pcs.

**AP-150FP**

45x45 Data ve Telefon Priz Kapağı 2'li  
45x45 Data and Telephone Socket Double  
Kutu: 25  
Box: 100 Pcs.

**AP-150UPS**

45 x 45 Tekli UPS Priz  
Single UPS Socket  
Kutu: 100 Adet  
Box: 100 Pcs.

**AP-150UPST**

Tekli Şebeke Priz  
Single Graunded Socket  
Kutu: 100 Adet  
Box: 100 Pcs.

**AP-150DT02**

CAT5 Data  
CAT5 Data  
Kutu: 100 Adet  
Box: 100 Pcs.

**AP-150DT03**

CAT6 Data  
CAT6 Data  
Kutu: 100 Adet  
Box: 100 Pcs.

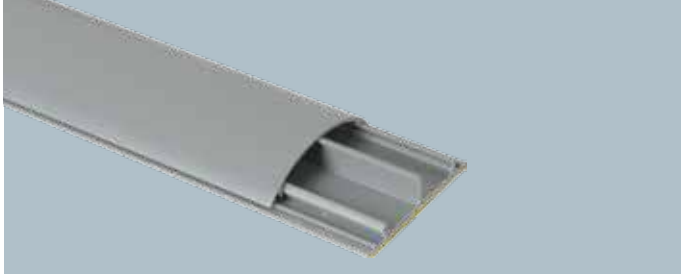
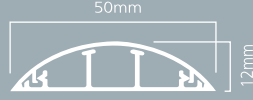

**50 x 12**

Ürün Kodu - Product Code

**APSZ 500 x 12**

Ambalaj Miktarı - Package Total

60 m

Ambalaj Şekli - Package

Kutu - Box

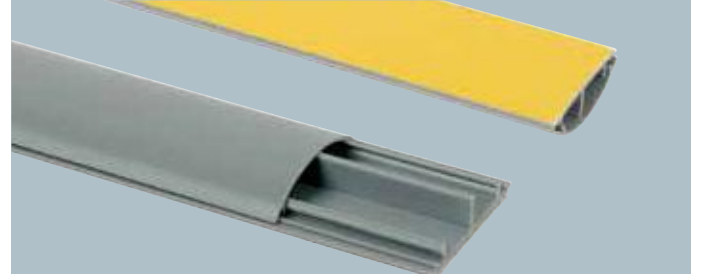
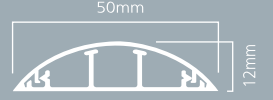
**50 x 12**

Ürün Kodu - Product Code

**APSZY 500 x 12**

Ambalaj Miktarı - Package Total

60 m

Ambalaj Şekli - Package

Kutu - Box

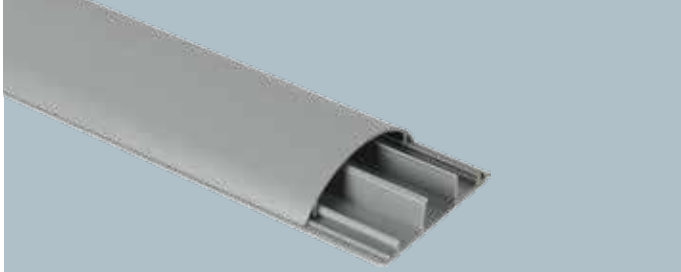
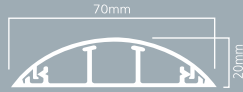
**70 x 20**

Ürün Kodu - Product Code

**APSZ 700 x 12**

Ambalaj Miktarı - Package Total

60 m

Ambalaj Şekli - Package

Kutu - Box

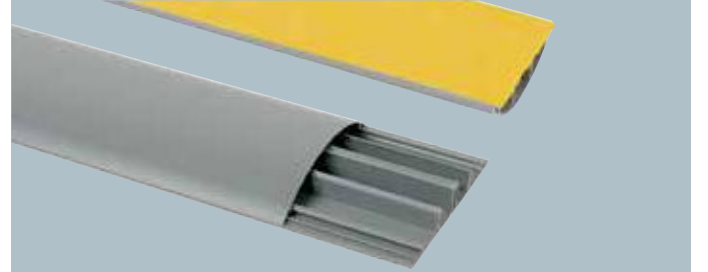
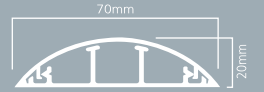
**70 x 20**

Ürün Kodu - Product Code

**APSZY 700 x 12**

Ambalaj Miktarı - Package Total

60 m

Ambalaj Şekli - Package

Kutu - Box

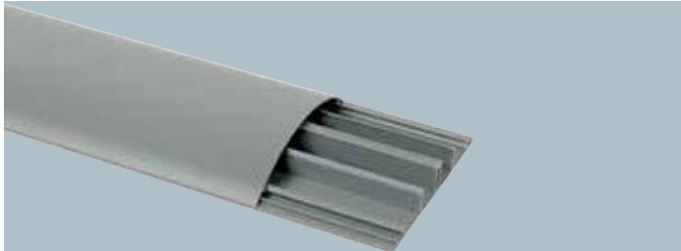
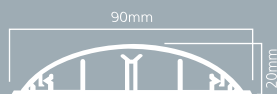
**90 x 20**

Ürün Kodu - Product Code

**APSZ 900 x 20**

Ambalaj Miktarı - Package Total

20 m

Ambalaj Şekli - Package

Kutu - Box

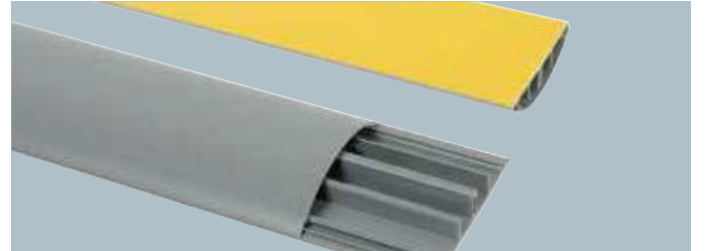
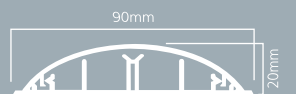
**90 x 20**

Ürün Kodu - Product Code

**APSZY 900 x 20**

Ambalaj Miktarı - Package Total

20 m

Ambalaj Şekli - Package

Kutu - Box



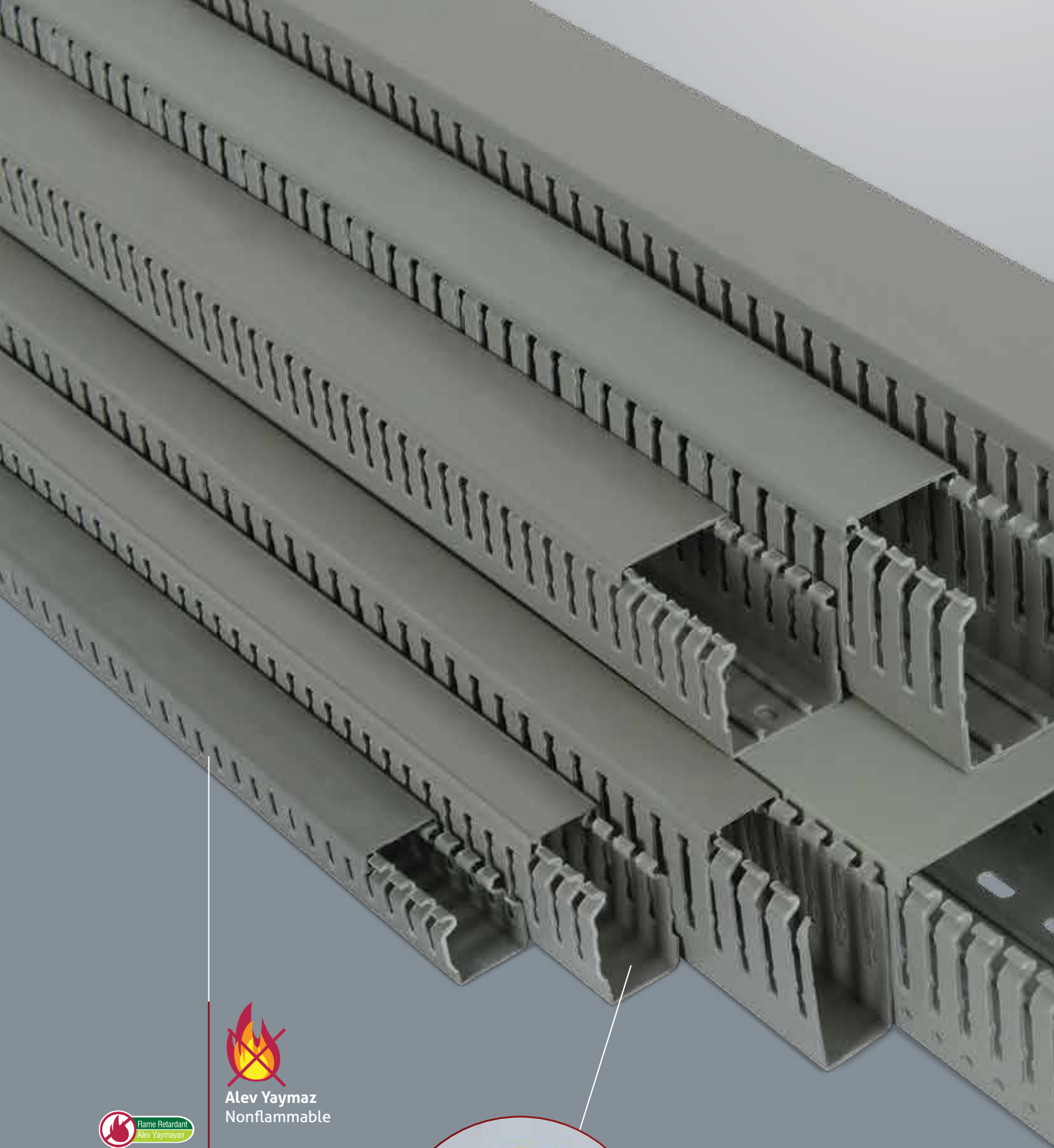

**Alev Yayımaz**  
Nonflammable

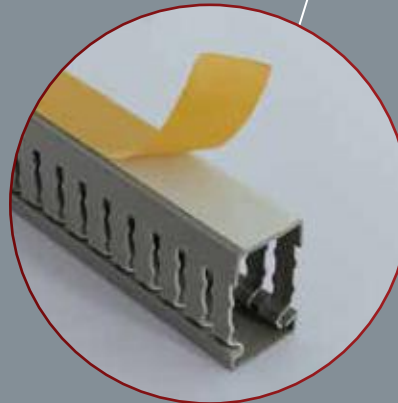

**Kolay yapışmayı sağlayan,**  
**Çift taraflı bant kullanılabilir.**  
Easy attached double sided adhesive  
tape could be used



## Pano tipi kablo kanallarımızın teknik özellikleri

### Technical Specifications for our Slotted Cable Trunkings

Özel kapak dizaynı sayesinde kolay kapanma ve açılma, dikey pozisyonda dahi en iyi performans. Special design of cover provides easy closing and opening and show the best performance even in vertical position.

Alt kırılma noktası sayesinde yan keski vb. alet kullanarak kanal yan duvarının kolayca kırılarak hızlı montaj sağlanması. With the cutting point at the bottom easily breaking sides and installed on the wall without using any tool.

Üst kırılma noktası sayesinde herhangi bir el aletine ihtiyaç duymadan kanal yanlarında bulunan tırnakların kolayca kırılarak hızlı montaj sağlanması. The breaking points on the top provide easy breaking side nails and fast installation.

Tabanda bulunan raylar sayesinde kanal tutucu vb. aksesuarların kolayca montajı. The rails on the bottom helps to assembly holders and other accessories easily.

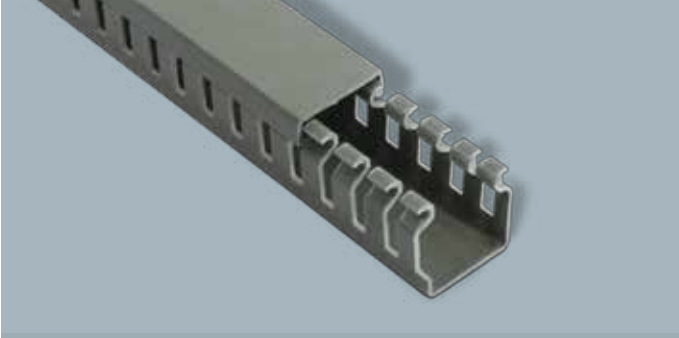

**25 x 25**

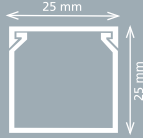

Ürün Kodu - Product Code

**APSG-25025**

Ambalaj Miktarı - Package total (m) 100 m

Ambalaj şekli - Package Kutu - Box



**25 x 40**

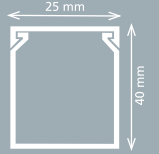

Ürün Kodu - Product Code

**APSG-25040**

Ambalaj Miktarı - Package total (m) 80 m

Ambalaj şekli - Package Kutu - Box

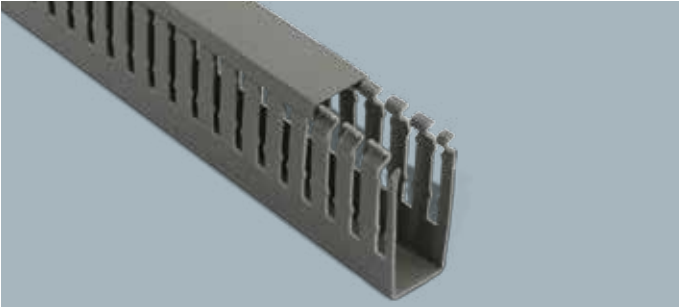

**25 x 60**

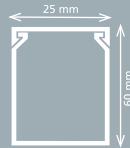

Ürün Kodu - Product Code

**APSG-25060**

Ambalaj Miktarı - Package total (m) 48 m

Ambalaj şekli - Package Kutu - Box

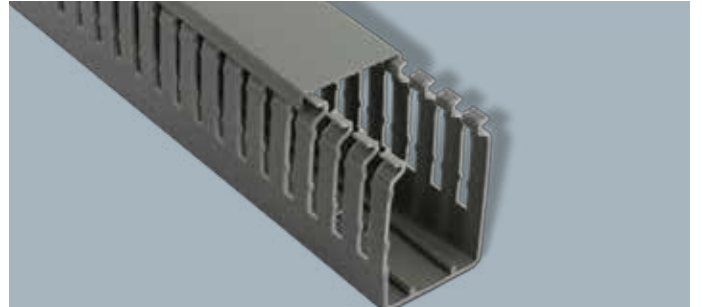

**40 x 40**

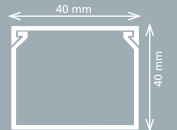

Ürün Kodu - Product Code

**APSG-40040**

Ambalaj Miktarı - Package total (m) 72 m

Ambalaj şekli - Package Kutu - Box

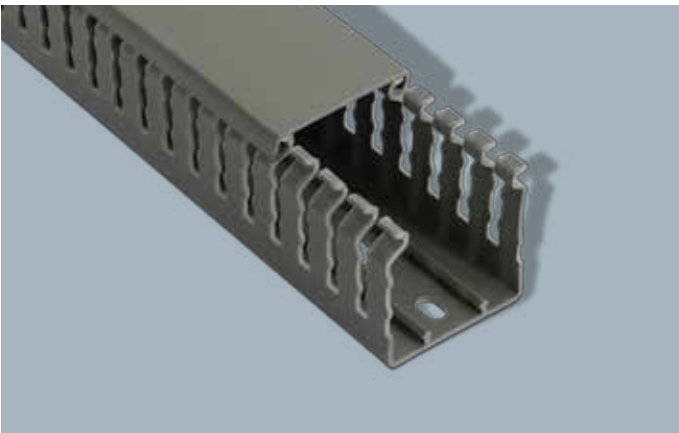

**40 x 60**

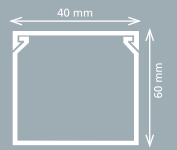

Ürün Kodu - Product Code

**APSG-40060**

Ambalaj Miktarı - Package total (m) 48 m

Ambalaj şekli - Package Kutu - Box

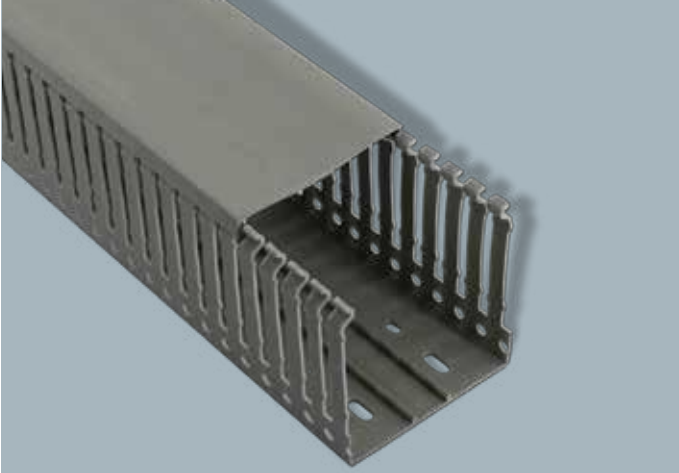
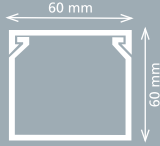
**60 x 60**

Ürün Kodu - Product Code

**APSG-60060**

Ambalaj Miktarı - Package total (m)

32 m

Ambalaj şekli - Package

Kutu - Box

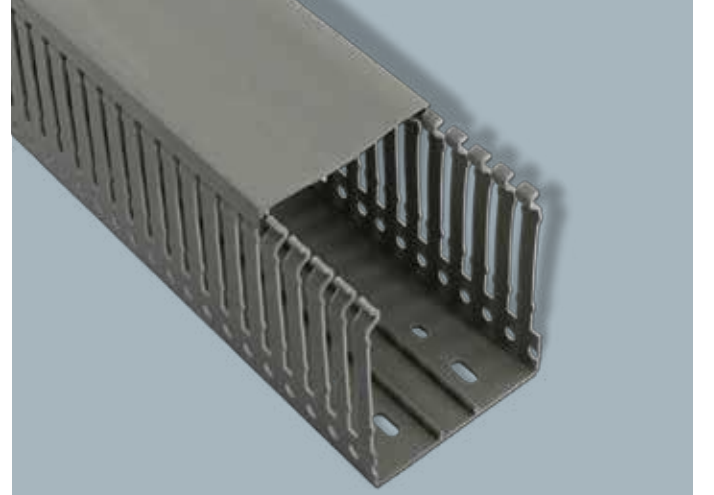
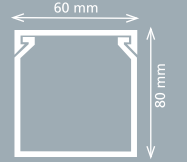
**60 x 80**

Ürün Kodu - Product Code

**APSG-60080**

Ambalaj Miktarı - Package total (m)

24 m

Ambalaj şekli - Package

Kutu - Box

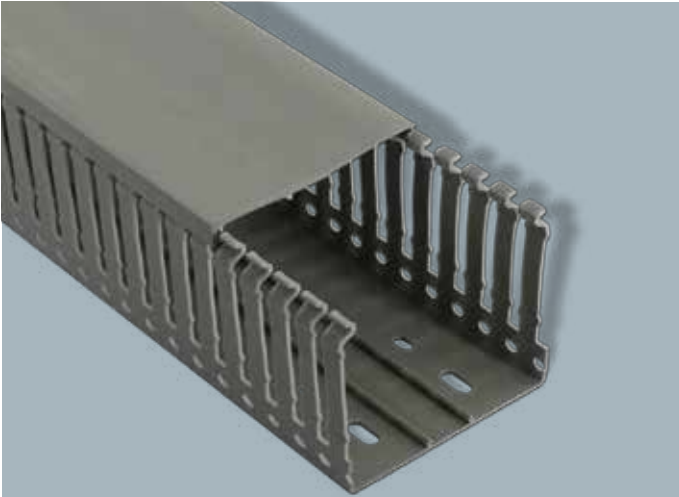
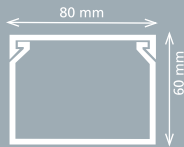
**80 x 60**

Ürün Kodu - Product Code

**APSG-80060**

Ambalaj Miktarı - Package total (m)

24 m

Ambalaj şekli - Package

Kutu - Box

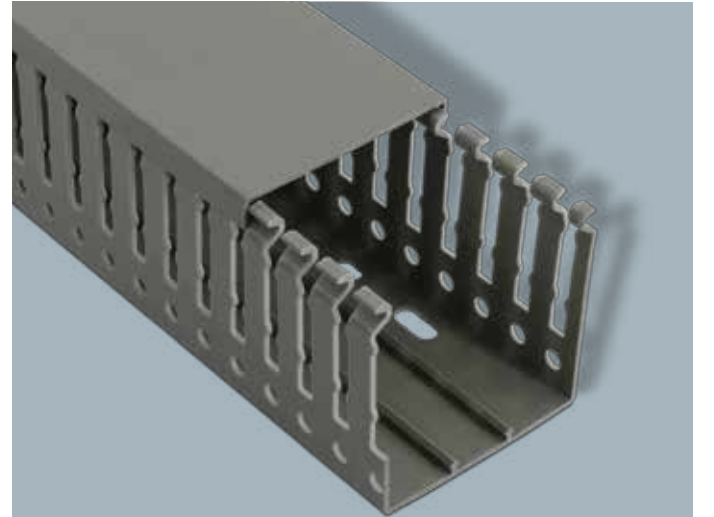
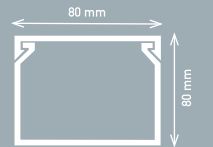
**80 x 80**

Ürün Kodu - Product Code

**APSG-80080**

Ambalaj Miktarı - Package total (m)

18 m

Ambalaj şekli - Package

Kutu - Box



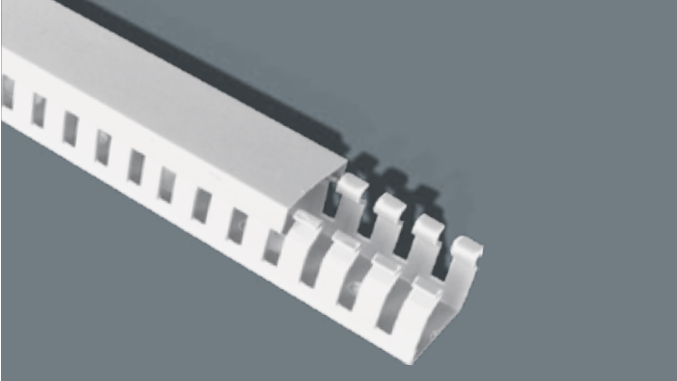

**25 x 25**

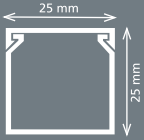

Ürün Kodu - Product Code  
**APSMB-25025**

Ambalaj Miktarı - Package total (m) 100 m

Ambalaj şekli - Package Kutu - Box

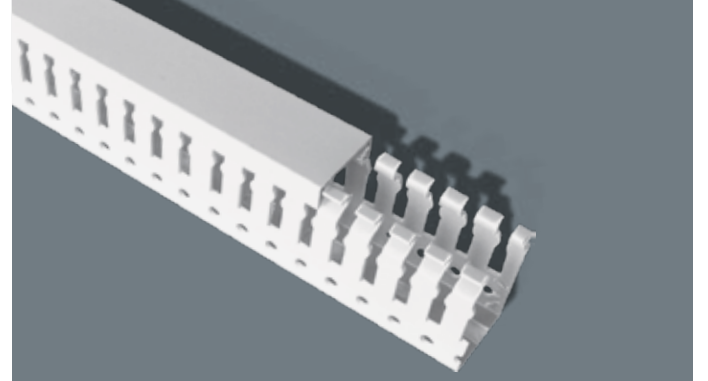

**25 x 40**

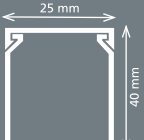

Ürün Kodu - Product Code  
**APSMB-25040**

Ambalaj Miktarı - Package total (m) 80 m

Ambalaj şekli - Package Kutu - Box

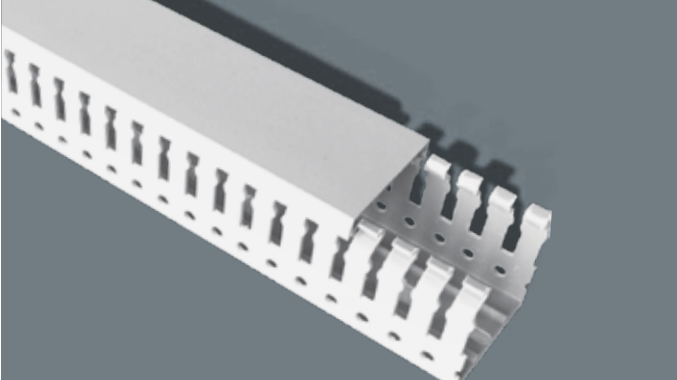

**25 x 60**

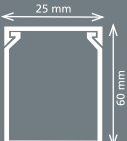

Ürün Kodu - Product Code  
**APSMB-25060**

Ambalaj Miktarı - Package total (m) 48 m

Ambalaj şekli - Package Kutu - Box

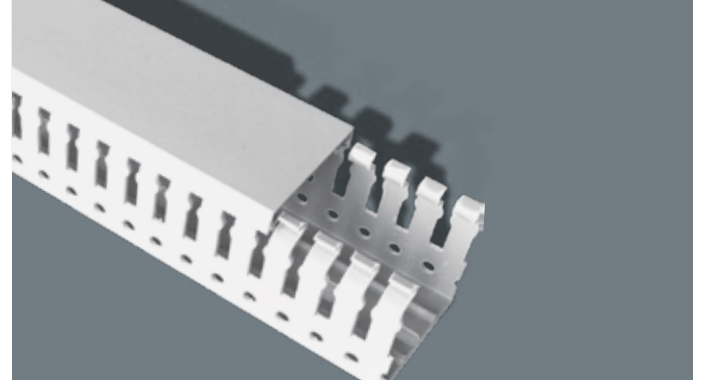

**40 x 40**

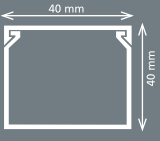

Ürün Kodu - Product Code  
**APSMB-40040**

Ambalaj Miktarı - Package total (m) 72 m

Ambalaj şekli - Package Kutu - Box



**40 x 60**



Ürün Kodu - Product Code  
**APSMB-40060**

Ambalaj Miktarı - Package total (m) 48 m

Ambalaj şekli - Package Kutu - Box

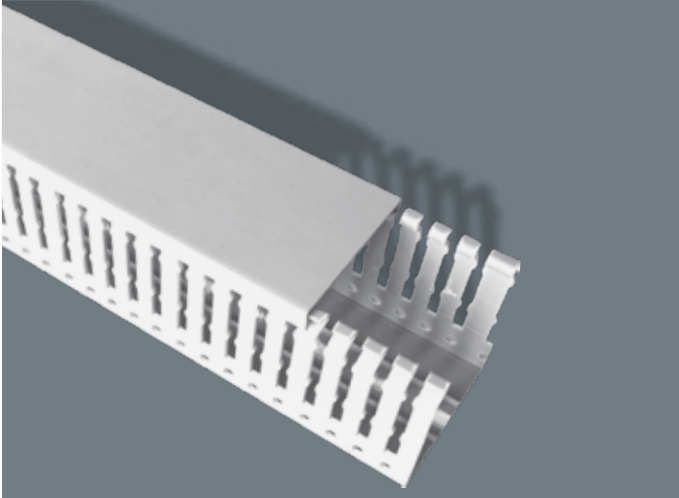
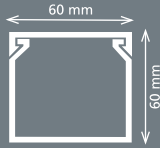
**60 x 60**

Ürün Kodu - Product Code

**APSMB-60060**

Ambalaj Miktarı - Package total (m) 32 m

Ambalaj şekli - Package Kutu - Box

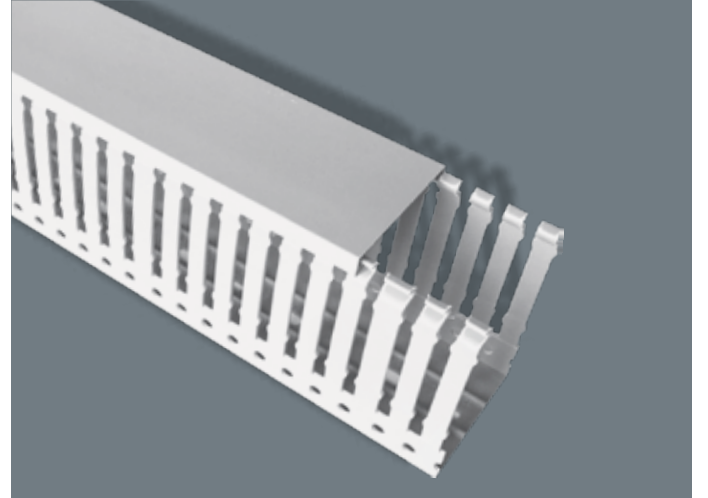
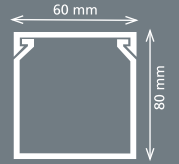
**60 x 80**

Ürün Kodu - Product Code

**APSMB-60080**

Ambalaj Miktarı - Package total (m) 24 m

Ambalaj şekli - Package Kutu - Box

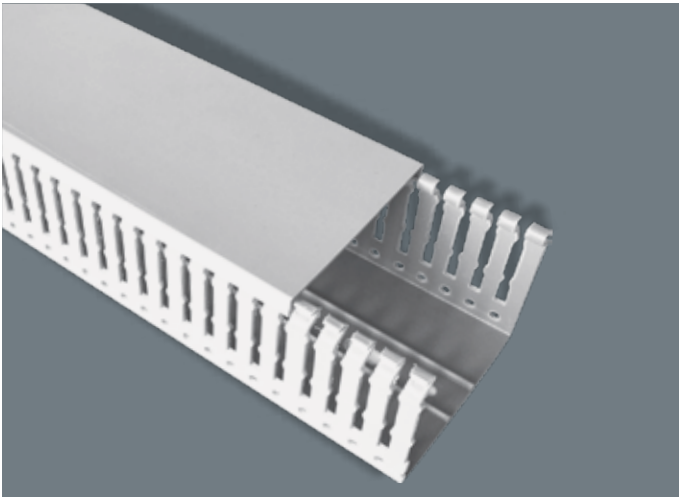
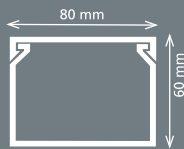
**80 x 60**

Ürün Kodu - Product Code

**APSMB-80060**

Ambalaj Miktarı - Package total (m) 24 m

Ambalaj şekli - Package Kutu - Box

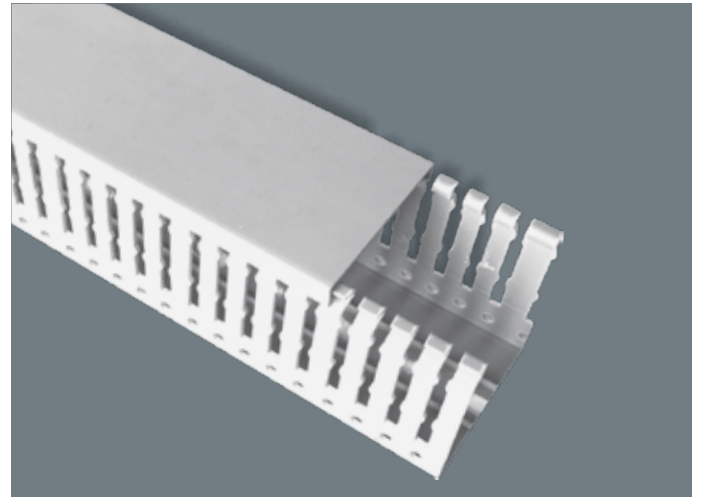
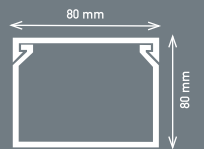
**80 x 80**

Ürün Kodu - Product Code

**APSMB-80080**

Ambalaj Miktarı - Package total (m) 18 m

Ambalaj şekli - Package Kutu - Box



**AK 77 110 00**

Topraksız Erkek Fiş - Ungrounded Male Plug



**AK 77 111 00**

Topraksız Dişi Fiş - Ungrounded Female Plug



**AK 77 148 00**

Anahtarlı Topraklı Erkek Fiş - Grounded Male Plug With Switch



**AK 77 112 00**

Topraklı Erkek Fiş (L Tipi) - Grounded Male Plug (L Type)



**AK 77 135 00**

Safir Topraklı Erkek Fiş - Sapphire Grounded Male Plug



**AK 77 115 00**

Topraklı Erkek Fiş - Grounded Male Plug



**AK 77 116 00**

Topraklı Erkek Fiş (Kulplu) - Grounded Male Plug (With Handle)



**AK 77 117 00**

Topraklı Dişi Fiş - Grounded Male Plug

KOD - CODE	ÜRÜN TANIMI - PRODUCT DESCRIPTION	ADET - PIECE
<b>AK 77 110 00</b>	Topraksız Erkek Fiş	50/500
<b>AK 77 111 00</b>	Topraksız Dişi Fiş	60/600
<b>AK 77 112 00</b>	L tipi Topraklı Erkek Fiş	50/500
<b>AK 77 148 00</b>	Anahtarlı Topraklı Erkek Fiş	40/400
<b>AK 77 115 00</b>	Topraklı Erkek Fiş	50/500
<b>AK 77 116 00</b>	Topraklı Erkek Fiş (Kulplu)	50/500
<b>AK 77 135 00</b>	Safir Topraklı Erkek Fiş	50/500
<b>AK 77 117 00</b>	Topraklı Dişi Fiş	25/500

## Standart Dübel - Standart Dowel

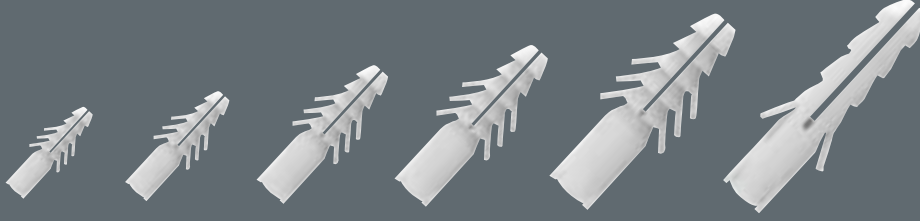

KOD - CODE	EN MM.	BOY MM.	PAKET ADEDİ - PACKAGE PCS.	ÇUVAL MİKTARI - SACK QUANTITY
AK 001	6	29	1000	50
AK 002	7	32	1000	25
AK 003	8	34	1000	25
AK 004	10	44	500	50
AK 005	12	48	500	20
AK 006	14	72	250	20

## Korniş Montaj Dübel - Cornice Dowel

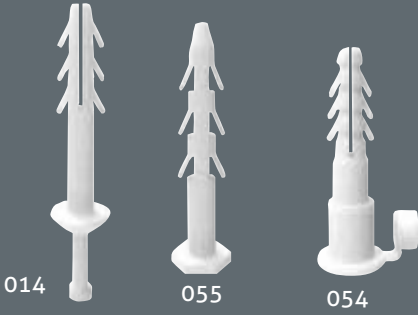

KOD CODE	ÜRÜN ADI PRODUCT NAME	EN MM.	BOY MM.	PAKET ADEDİ PACKAGE PCS.	ÇUVAL MİKTARI SACK QUANTITY
014	Çivili Dübel EXTRA	7	53	500	25
055	Mega Dübel	8	53	500	25
054	Kapaklı Dübel	10	53	500	25

## Kablo Bağı Dübeli ve Kroşesi



KOD - CODE	ÜRÜN ADI - PRODUCT NAME	PAKET ADEDİ - PACKAGE PCS.	KOLİ ADEDİ - BOX PCS.
DB.02128	Delikli Duvar Kroşe 7 mm.	100	10.000
DB.0155	Kablo Bağı Dübeli 8 mm. (Lok Kroşe)	100	5.000
DB.0156	Kablo Bağı Dübeli 10 mm. (Lok Kroşe)	100	5.000

## Tekli &amp; Çiftli Kroşeler



KOD - CODE	ÜRÜN ADI - PRODUCT NAME	PAKET ADEDİ - PACKAGE PCS.	KOLİ ADEDİ - BOX PCS.
DB.02144	Tekli Kroşe 8 x 18	500	5.000
DB.02150	Çiftli Kroşe 20 mm	100	4.000
DB.02151	Çiftli Kroşe 25 mm	100	3.000



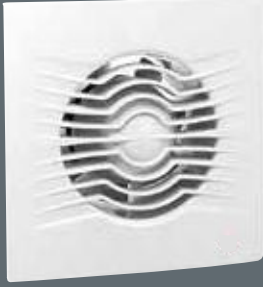

### 100 ASPIRATÖR - ASPIRATOR

Ürün Kodu - Product Code

**AK - S100**

Gerilim - Voltage	v230
Debi - Flow	90 m <sup>3</sup> /h
Devir - Rotation	2.600 d/d - 15w

Kutu - Box Pcs. : 20

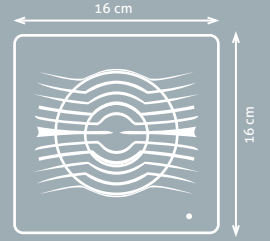

### 120 ASPIRATÖR - ASPIRATOR

Ürün Kodu - Product Code

**AK - S120**

Gerilim - Voltage	v230
Debi - Flow	180 m <sup>3</sup> /h
Devir - Rotation	2.250 d/d - 20w

Kutu - Box Pcs. : 20

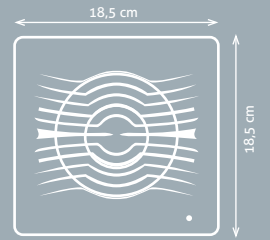

### 150 ASPIRATÖR - ASPIRATOR

Ürün Kodu - Product Code

**AK - S150**

Gerilim - Voltage	v230
Debi - Flow	280 m <sup>3</sup> /h
Devir - Rotation	2.100 d/d - 25w

Kutu - Box Pcs. : 20

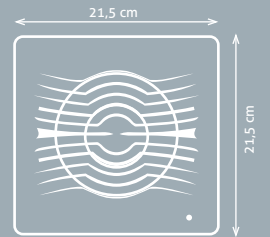

**YENİ ÜRÜN**  
 NEW PRODUCT

**KAPAKLI ASPIRATÖRLER - COVERED ASPIRATORS**
**TKA SERİSİ**

Ürün Kodu Product Code	Güç Power	Gerilim Voltage	Debi Flow	Koli Box
TKA - 160	40	230	400	8
TKA - 200	40	230	650	8
TKA - 250	50	230	800	8
TKA - 300	60	230	1000	8

**YENİ ÜRÜN**  
 NEW PRODUCT

**KAPAKSIZ BACA, DUVAR ASPIRATÖRLERİ  
COVERLESS CHIMNEY, WALL ASPIRATORS**
**TBA SERİSİ**

Ürün Kodu Product Code	Güç Power	Gerilim Voltage	Debi Flow	Koli Box
TBA - 160	40	230	400	8
TBA - 200	40	230	650	8
TBA - 250	50	230	800	8
TBA - 300	60	230	1000	8

**YENİ ÜRÜN**  
 NEW PRODUCT

**DUVAR TİPİ AKSİYEL ASPIRATÖRLERİ - WALL TYPE AXIAL ASPIRATORS**
**BA SERİSİ**

Ürün Kodu Product Code	Güç Power	Gerilim Voltage	Debi Flow	Koli Box
BA 160	40	230	380	8
BA 200	40	230	450	8
BA 250	40	230	660	8
BA 300	50	230	900	8
BA 350	60	230	1100	8

**YENİ ÜRÜN**  
 NEW PRODUCT

**SANAYİ TİPİ ASPIRATÖRLERİ - INDUSTRIAL TYPE ASPIRATORS**

Ürün Kodu Product Code	Güç Power	Gerilim Voltage	Devir Rotation	Debi Flow	Koli Box
S25M / S25T	125	230/380	1400	1200	2
S30M / S30T	125	230/380	1400	2200	2
S35M / S35T	155	230/380	1400	3200	2
S40M / S40T	180	230/380	1400	4100	2
S45M / S45T	220	230/380	1400	4800	2
S50M / S50T	250	230/380	1400	5200	2
S60M / S60T	290	230/380	1400	7500	1
S25M / S25T 2K	180	230/380	2800	2400	2

**YENİ ÜRÜN**  
 NEW PRODUCT

**SANAYİ TİPİ ASPIRATÖRLERİ - INDUSTRIAL TYPE ASPIRATORS**

Ürün Kodu Product Code	Güç Power	Gerilim Voltage	Devir Rotation	Debi Flow	Koli Box
KS25M / KS25T	125	230/380	1400	1200	2
KS30M / KS30T	125	230/380	1400	2200	2
KS35M / KS35T	155	230/380	1400	3200	2
KS40M / KS40T	180	230/380	1400	4100	2
KS45M / KS45T	220	230/380	1400	4800	2
KS50M / KS50T	250	230/380	1400	5200	2
KS60M / KS60T	290	230/380	1400	7500	1
KS25M / KS25T 2K	180	230/380	2800	2400	2



**Alev İletmez**  
**Nonflammable**



**Flame Retardant**  
**Alev Yayımayan**



**IK Derecesi**  
**IK Degree : IK08**

# ABS panolarımızın teknik özellikleri

Technical Specification of  
ABS Panel Boards



**IP65**



**Kilit Sistemi**  
Lock System



**1 mm Galvanizli Çelik Montaj Plakası**  
1 mm Galvanized Steel Mounting Plate







## ABS Termoplastik Buat - ABS Thermoplastic Box

KOD CODE	ÜRÜN ÖLÇÜLERİ SIZE	KORUMA SINIFI PROTECTION CLASS	RENK COLOUR	KOLİ ADEDİ BOX PCS
<b>ABS-757540</b>	70x70x40	IP 55 (67 Tire Opsiyonel)	Gri-Grey	1
<b>ABS-858540</b>	85x75x45	IP 55 (67 Tire Opsiyonel)	Gri-Grey	1
<b>ABS-11011090</b>	110x110x50	IP 55 (67 Tire Opsiyonel)	Gri-Grey	1
<b>ABS-8012065</b>	80x120x60	IP 55 (67 Tire Opsiyonel)	Gri-Grey	1
<b>ABS-80120110</b>	110x150x65	IP 55 (67 Tire Opsiyonel)	Gri-Grey	1
<b>ABS-13023085</b>	110x180x65	IP 55 (67 Tire Opsiyonel)	Gri-Grey	1
<b>ABS-130230120</b>	130x230x85	IP 55 (67 Tire Opsiyonel)	Gri-Grey	1
<b>ABS-230310130</b>	200x250x90	IP 55 (67 Tire Opsiyonel)	Gri-Grey	1
<b>ABS-230310180</b>	230x310x130	IP 55 (67 Tire Opsiyonel)	Gri-Grey	1
<b>ABS-12021065</b>	120x210x65	IP 55 (67 Tire Opsiyonel)	Gri-Grey	1
<b>ABS-14019065</b>	140x190x65	IP 55 (67 Tire Opsiyonel)	Gri-Grey	1



## Şeffaf Kapaklı Buat - ABS Thermoplastic Box with Transparent Cover

KOD CODE	ÜRÜN ÖLÇÜLERİ SIZE	KORUMA SINIFI PROTECTION CLASS	RENK COLOUR	KOLİ ADEDİ BOX PCS
<b>ABSA-11011090</b>	110x110x90	IP 55 (67 Tire Opsiyonel)	Gri-Grey	1
<b>ABSA-110110120</b>	110x110x120	IP 55 (67 Tire Opsiyonel)	Gri-Grey	1
<b>ABSA-8012065</b>	80x120x100	IP 55 (67 Tire Opsiyonel)	Gri-Grey	1
<b>ABSA-11150110</b>	11x150x110	IP 55 (67 Tire Opsiyonel)	Gri-Grey	1
<b>ABSA-11180115</b>	11x180x115	IP 55 (67 Tire Opsiyonel)	Gri-Grey	1
<b>ABSA-13023085</b>	130x230x85	IP 55 (67 Tire Opsiyonel)	Gri-Grey	1
<b>ABSA-130230120</b>	130x230x120	IP 55 (67 Tire Opsiyonel)	Gri-Grey	1
<b>ABSA-230310130</b>	230x310x130	IP 55 (67 Tire Opsiyonel)	Gri-Grey	1



## ABS Pano - ABS Board



### TEKNİK ÖZELLİKLER

Hammadde : ABS (Ral 7035 Gri)  
 Isı dayanıklı : -40°C / +80°C  
 Darbe dayanıklı  
 Standart tip panolar için 650°C kızaran tel deneyi  
 HF yanmaz panolar için 960°C kızaran tel deneyi  
 Paslanmaz çelik vidalı kapak  
 Taban sacı  
 Kilit sistemi  
 Montaj rayı ve klemens takmaya müsait gövde tasarımı  
 Alçak gerilim şalt ekipmanları montaja müsait yapı

### TECHNICAL SPECIFICATIONS

Material : ABS (Ral 7035 Gri)  
 Health Strangth : -40°C / +80°C  
 Impact resitant  
 650°C glow wire test for standart type  
 960°C glow wire test for HF type  
 Stainless stell screws for cover  
 Steinless temm base plate  
 Lock system  
 Design provided installation for DIN rails and terminals  
 Suitable to assembly low voltage swichtchgear equipment



KOD  
CODE

ÜRÜN ÖLÇÜLERİ  
SIZE

KOLİ ADEDİ  
BOX PCS

AKAB - 200130	200x300x130	1
AKAB - 250150	250x350x150	1
AKAB - 300400	300x400x170	1
AKAB - 300220	300x400x220	1
AKAB - 350190	350x500x190	1
AKAB - 400180	400x500x180	1
AKAB - 400240	400x500x240	1
AKAB - 400200	400x600x200	1
AKAB - 500600	500x600x220	1
AKAB - 500250	500x700x250	1
AKAB - 600800	600x800x260	1



## PC Şeffaf Kapaklı Likarbonat Panolar - ABS Panel Boards With Pc Transparent Door



### TEKNİK ÖZELLİKLER

Hammadde : ABS (Ral 7035 Gri)  
Isı dayanıklı : -40°C / +80°C  
Darbe dayanıklı  
Standart tip panolar için 650°C kızaran tel deneyi  
HF yanmaz panolar için 960°C kızaran tel deneyi  
Paslanmaz çelik vidalı kapak  
Taban sacı  
Kilit sistemi  
Montaj rayı ve klemens takmaya müsait gövde tasarımı  
Alçak gerilim şalt ekipmanları montaja müsait yapı

### TECHNICAL SPECIFICATIONS

Material : ABS (Ral 7035 Gri)  
Health Strangth : -40°C / +80°C  
Impact resitant  
650°C glow wire test for standart type  
960°C glow wire test for HF type  
Steinless stell screws for cover  
Steinless tenn base plate  
Lock system  
Design provided installation for DIN rails and terminals  
Suitable to assembly low voltage swichtchgear equipment



KOD  
CODE

ÜRÜN ÖLÇÜLERİ  
SIZE

KOLİ ADEDİ  
BOX PCS

AKPC - 200130

200x300x130

1

AKPC - 250150

250x350x150

1

AKPC - 300400

300x400x170

1

AKPC - 300220

300x400x220

1

AKPC - 350190

350x500x190

1

AKPC - 400180

400x500x180

1

AKPC - 400240

400x500x240

1

AKPC - 400200

400x600x200

1

AKPC - 500600

500x600x220

1

AKPC - 500250

500x700x250

1

AKPC - 600800

600x800x260

1





### TEKNİK ÖZELLİKLER

Ham madde	: Cam Elyaf Takviyeli Polyester
Kalite Standartı	: EN61439, EN60670-1
Renk	: RAL 7035 (Renk Seçenekleri Vardır)
Çalışma Sıcaklığı	: -40°C + 70°C
Kapak Açılma Açısı	: 210
Menteşe	: 3 adet
Kilit	: 2 adet
Kilit Seçenekleri	: Üçgen, Kelebek, Yaylı, Sıkıştırılmalı (Metal veya Plastik)
Koruma Sınıfı	: IP 65
Yangın Dayanımı	: B2 (İstenildiğinde A1, A2, B1 V0 yapılabilir)
UV Dayanımı	: Evet
Nem Dayanımı	: Evet
Kimyasal Dayanımı	: Asit ve Bazlara Karşı Yüksek Dayanım
Conta	: Poliüretan Dökme Conta veya EPDM Conta
Topraklama Sınıfı	: Class II

### KOD CODE

### ÜRÜN ÖLÇÜLERİ SIZE

### KOLİ ADEDİ BOX PCS

<b>APP203012E</b>	200x300x120	8
<b>APP213213E</b>	210x320x130	8
<b>APP253017E</b>	250x300x170	6
<b>APP304017E</b>	300x400x170	4
<b>APP335017E</b>	350x500x170	2
<b>APP406032E</b>	400x600x200	1
<b>APP507020</b>	400x700x200	1
<b>APP608022E</b>	60x800x220	1



### GENEL ÖZELLİKLER

- Paslanmaz, çizilmez, boya bakım gerektirmez.
- Elektrik iletmez, yalıtıcıdır.
- Alev iletmez ve kendiliğinden söner.
- Rutubet, nem barındırmaz.
- Atmosferik şartlara karşı dayanıklıdır.
- Üzerine logo istenildiği gibi yapılabilir.

### UYGULAMA ALANLARI

- Trafo kuvvet panoları
- Kompanzasyon panoları
- Dağıtım panoları
- Şebeke jeneratör
- Otomasyon panoları
- Kumanda panoları
- Aydınlatma panoları
- OSOS panoları
- Sayaç panoları

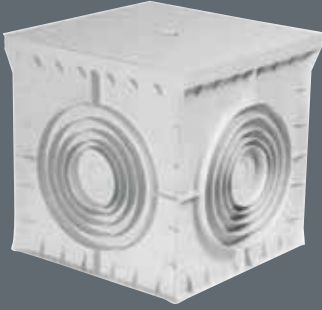

**20 x 20**

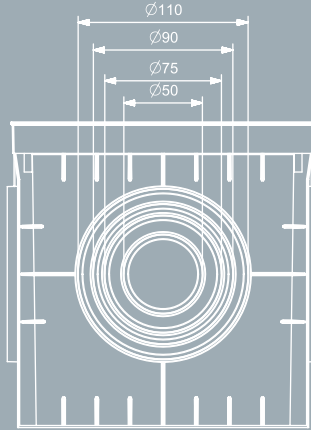

**IP 54**

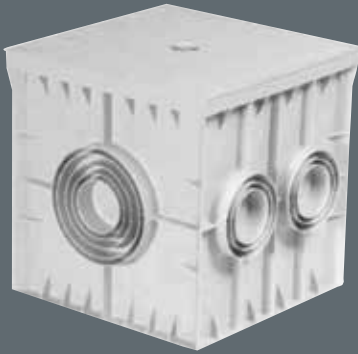
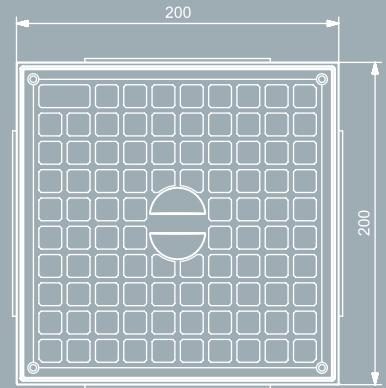

**30 x 30**

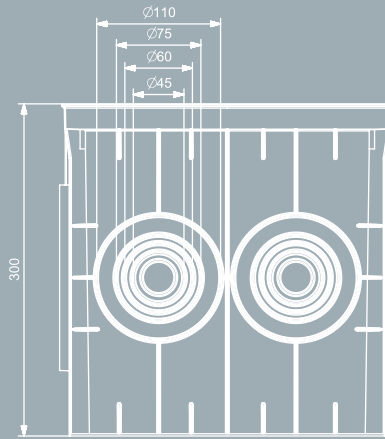

**IP 54**

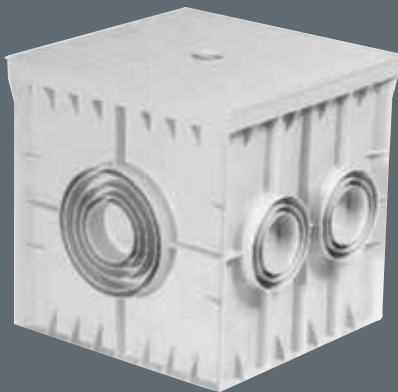
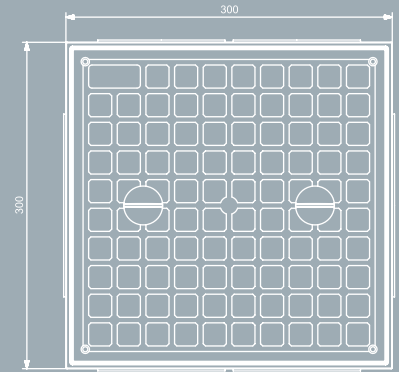

**40 x 40**

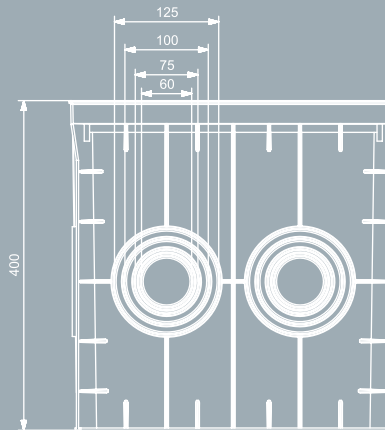

**IP 54**

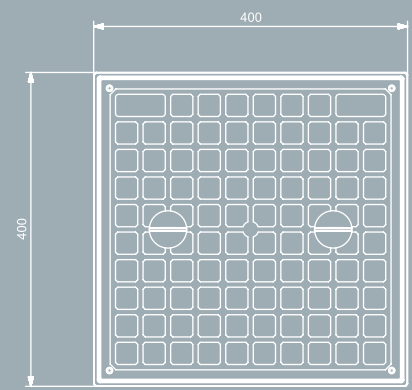



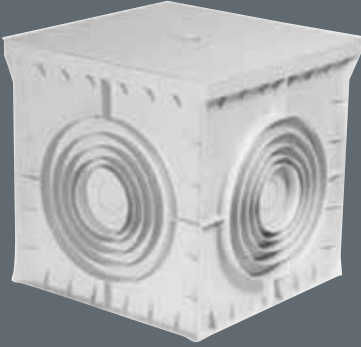

**50 x 50**

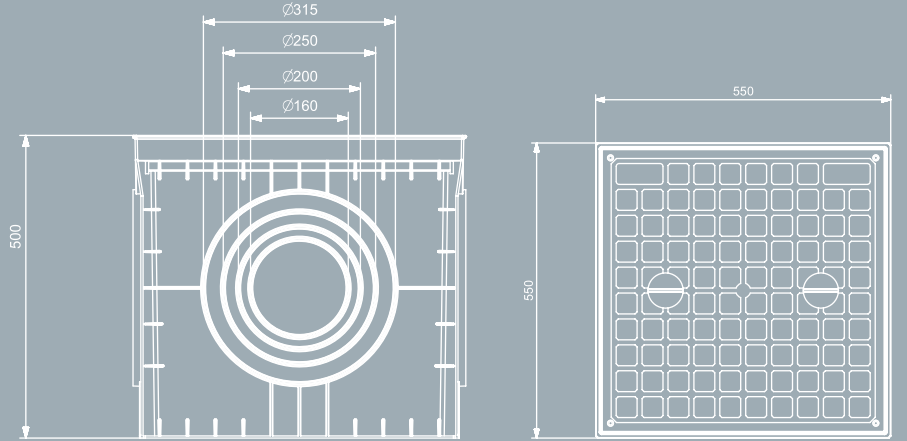

**IP 54**

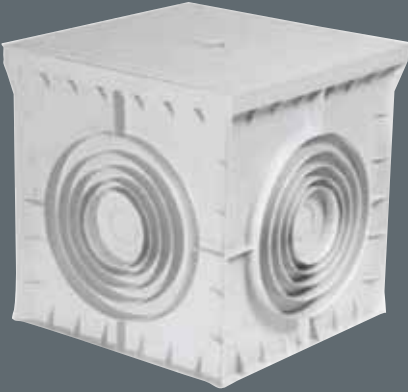

**55 x 55**

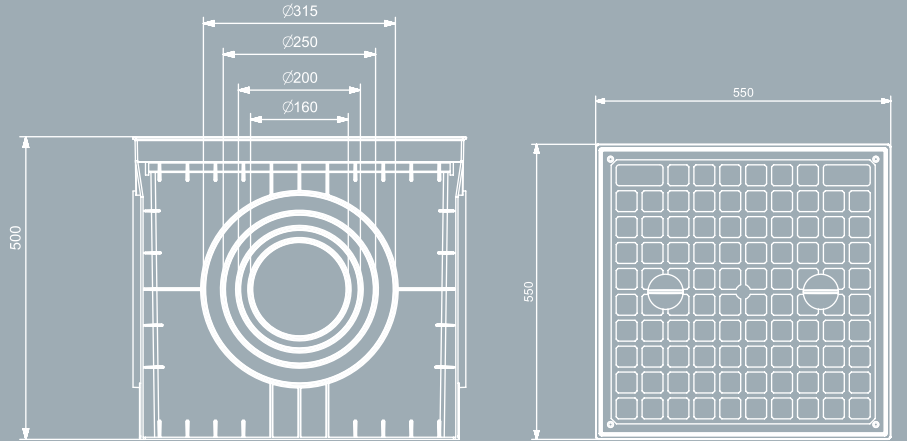

**IP 54**

KOD CODE	ÜRÜN ADI PRODUCT NAME	ÜRÜN ÖLÇÜLERİ DIMENSIONS	KOLİ BOX
<b>AK-20202000</b>	YERALTı BUATI - UNDERGROUND BOARD	200x200x200 mm	1
<b>AK-30303001</b>	YERALTı BUATI - UNDERGROUND BOARD	300x300x300 mm	1
<b>AK-40404002</b>	YERALTı BUATI - UNDERGROUND BOARD	400x400x400 mm	1
<b>AK-51555503</b>	YERALTı BUATI - UNDERGROUND BOARD	500x500x500 mm	1
<b>AK-550550500</b>	YERALTı BUATI - UNDERGROUND BOARD	550x550x500 mm	1

**Teknik Özellik : Hammadde yüksek yoğunluklu PP**

PC ŞEFFAF KAPAK  
PC TRANSPARENT DOOR



Kolayca açılıp kapanabilen  
kilit sistemi  
Easy to open and close  
Lock system



## Sigorta kutularımızın teknik özellikleri

Technical Specification of Fuse Boxes



Kolayca açılıp kapanabilen kilit sistemi  
Easy to open and close  
Lock system



IP40 Halogen Free





**1'li Sigorta Kutusu Mühürlü**  
Mounted Fuse Box 1 Fuses

**2'li Sigorta Kutusu Mühürlü**  
Mounted Fuse Box 2 Fuses

**3-4'lü Sigorta Kutusu Mühürlü**  
Mounted Fuse Box 3-4 Fuses

Ürün Kodu - Product Code **AKSU - 1**  
Koli Adet - Box Pcs. 243

Ürün Kodu - Product Code **AKSU - 2**  
Koli Adet - Box Pcs. 180

Ürün Kodu - Product Code **AKSU - 3/4**  
Koli Adet - Box Pcs. 144



**Sıvaüstü 6'lı Sigorta Kutusu**  
Surface Mounted Fuse Box 6 Fuses

**Sıvaüstü 9'lu Sigorta Kutusu**  
Surface Mounted Fuse Box 9 Fuses

**Sıvaüstü 12'li Sigorta Kutusu**  
Surface Mounted Fuse Box 12 Fuses

Ürün Kodu - Product Code **AKSU - 6**  
Koli Adet - Box Pcs. 1

Ürün Kodu - Product Code **AKSU - 9**  
Koli Adet - Box Pcs. 1

Ürün Kodu - Product Code **AKSU - 12**  
Koli Adet - Box Pcs. 1



**Sıvaüstü 16'lı Sigorta Kutusu**  
Surface Mounted Fuse Box 16 Fuses

**Sıvaüstü 24'lı Sigorta Kutusu**  
Surface Mounted Fuse Box 24 Fuses

**Sıvaüstü 36'lı Sigorta Kutusu**  
Surface Mounted Fuse Box 36 Fuses

Ürün Kodu - Product Code **AKSU - 16**  
Koli Adet - Box Pcs. 1

Ürün Kodu - Product Code **AKSU - 24**  
Koli Adet - Box Pcs. 1

Ürün Kodu - Product Code **AKSU - 36**  
Koli Adet - Box Pcs. 1



**Sıvaaltı 6'lı Sigorta Kutusu**  
Flush Mounted Fuse Box 6 Fuses

Ürün Kodu - Product Code **AKSA - 6**  
Koli Adet - Box Pcs. 1



**Sıvaaltı 9'lu Sigorta Kutusu**  
Flush Mounted Fuse Box 9 Fuses

Ürün Kodu - Product Code **AKSA - 9**  
Koli Adet - Box Pcs. 1

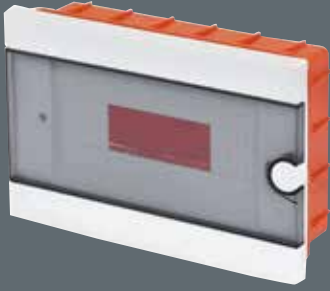

**Sıvaaltı 12'li Sigorta Kutusu**  
Flush Mounted Fuse Box 12 Fuses

Ürün Kodu - Product Code **AKSA - 12**  
Koli Adet - Box Pcs. 1



**Sıvaaltı 16'li Sigorta Kutusu**  
Flush Mounted Fuse Box 16 Fuses

Ürün Kodu - Product Code **AKSA - 16**  
Koli Adet - Box Pcs. 1



**Sıvaaltı 24'li Sigorta Kutusu**  
Flush Mounted Fuse Box 24 Fuses

Ürün Kodu - Product Code **AKSA - 24**  
Koli Adet - Box Pcs. 1



**Sıvaaltı 36'li Sigorta Kutusu**  
Flush Mounted Fuse Box 36 Fuses

Ürün Kodu - Product Code **AKSA - 36**  
Koli Adet - Box Pcs. 1





## Plastik Susta (Takviyeli) - Plastic Strina (Consolidated)

KOD CODE	ÜRÜN ÖLÇÜLERİ SIZE	KOLİ ADEDİ BOX PCS
<b>APP10005</b>	5 mt plastik susta - 5 mt plastic strina consolidated	40
<b>APP10010</b>	10 mt plastik susta - 10 mt plastic strina consolidated	25
<b>APP10015</b>	15 mt plastik susta - 15 mt plastic strina consolidated	20
<b>APP10020</b>	20 mt plastik susta - 20 mt plastic strina consolidated	15
<b>APP10025</b>	25 mt plastik susta - 25 mt plastic strina consolidated	13
<b>APP10030</b>	30 mt plastik susta - 30 mt plastic strina consolidated	10















## Çelik Susta - Steel Strina

KOD CODE	ÜRÜN ÖLÇÜLERİ SIZE	KOLİ ADEDİ BOX PCS
<b>APC10005</b>	5 mt çelik susta - 5 mt steel strina	40
<b>APC10010</b>	10 mt çelik susta - 10 mt steel strina	25
<b>APC10015</b>	15 mt çelik susta - 15 mt steel strina	20
<b>APC10020</b>	20 mt çelik susta - 20 mt steel strina	15
<b>APC10025</b>	25 mt çelik susta - 25 mt steel strina	13
<b>APC10030</b>	30 mt çelik susta - 30 mt steel strina	10



## Çelik Susta (Takviyeli) - Steel Strina (Consolidated)

KOD CODE	ÜRÜN ÖLÇÜLERİ SIZE	KOLİ ADEDİ BOX PCS
<b>APT10005</b>	5 mt çelik susta - 5 mt steel strina consolidated	40
<b>APT10010</b>	10 mt çelik susta - 10 mt steel strina consolidated	25
<b>APT10015</b>	15 mt çelik susta - 15 mt steel strina consolidated	20
<b>APT10020</b>	20 mt çelik susta - 20 mt steel strina consolidated	15
<b>APT10025</b>	25 mt çelik susta - 25 mt steel strina consolidated	13
<b>APT10030</b>	30 mt çelik susta - 30 mt steel strina consolidated	10

YENİ ÜRÜN NEW PRODUCT	KOD CODE	ÜRÜN ÖLÇÜLERİ SIZE	KOLİ ADEDİ BOX PCS
	<b>AKA365</b>	6 mm Sıkmalı Tip Kablo Pabucu - 6 mm Cable Lug	500
	<b>AKA366</b>	10 mm Sıkmalı Tip Kablo Pabucu - 10 mm Cable Lug	400
	<b>AKA367</b>	16 mm Sıkmalı Tip Kablo Pabucu - 16 mm Cable Lug	350
	<b>AKA368</b>	25 mm Sıkmalı Tip Kablo Pabucu - 25 mm Cable Lug	300
	<b>AKA369</b>	35 mm Sıkmalı Tip Kablo Pabucu - 35 mm Cable Lug	200
	<b>AKA370</b>	50 mm Sıkmalı Tip Kablo Pabucu - 50 mm Cable Lug	150
	<b>AKA371</b>	70 mm Sıkmalı Tip Kablo Pabucu - 70 mm Cable Lug	100
	<b>AKA372</b>	95 mm Sıkmalı Tip Kablo Pabucu - 95 mm Cable Lug	50
	<b>AKA373</b>	120 mm Sıkmalı Tip Kablo Pabucu - 120 mm Cable Lug	50
	<b>AKA374</b>	150 mm Sıkmalı Tip Kablo Pabucu - 150 mm Cable Lug	40
	<b>AKA375</b>	185 mm Sıkmalı Tip Kablo Pabucu - 185 mm Cable Lug	30
	<b>AKA376</b>	240 mm Sıkmalı Tip Kablo Pabucu - 240 mm Cable Lug	25

YENİ ÜRÜN  
NEW PRODUCT



**NH POLYESTER ALTLIKLI KOFRA**  
**NH POLYESTER HOODED COFFRA**

Ürün Kodu - Product Code

KB.5000

Koli Adedi - Box Pcs.

8

YENİ ÜRÜN  
NEW PRODUCT



**POLYESTER KOFRA (BOŞ)**  
**POLYESTER KOFRA (EMPTY)**

Ürün Kodu - Product Code

KB.5006

Koli Adedi - Box Pcs.

8

YENİ ÜRÜN  
NEW PRODUCT



**YÜK KESİCİLİ POLYESTER KOFRA**  
**LOAD BREAKER POLYESTER KOFRA**

Ürün Kodu - Product Code

KB.5007

Koli Adedi - Box Pcs.

8

YENİ ÜRÜN  
NEW PRODUCT



**POLYESTER BUŞON 32A. - 160A.**  
**POLYESTER BATTERY CAP 32A. - 160A.**

Ürün Kodu - Product Code

KB.5001

Koli Adedi - Box Pcs.

10

YENİ ÜRÜN  
NEW PRODUCT



**NH00 KLEMENSLİ POLYESTER ALTLIK**  
**NH00 TERMINAL POLYESTER BOTTLES**

Ürün Kodu - Product Code

KB.5002

Koli Adedi - Box Pcs.

10

YENİ ÜRÜN  
NEW PRODUCT



**DÖŞEME ALTI BUAT SAC 36 X 36**  
**UNDERFLOOR UNDERFLOOR SAC 36 X 36**

Ürün Kodu - Product Code

CA.10300

Koli Adedi - Box Pcs.

5

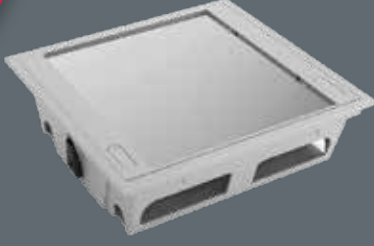
YENİ ÜRÜN  
NEW PRODUCT
**27 X 27 PRİZ KASASI ( 18 MODÜL)**  
**27 X 27 SOCKET CASE (18 MODULES)**

Ürün Kodu - Product Code	CA.10301
Koli Adedi - Box Pcs.	10

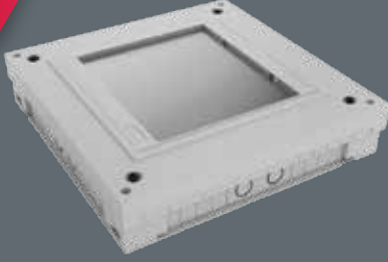
YENİ ÜRÜN  
NEW PRODUCT
**DÖŞEME ALTI BUAT (PLS) + PRİZ KUTUSU 354 X 354 MM**  
**UNDERFLOOR UNIT (PLS) + SOCKET BOX 354 X 354 MM**

Ürün Kodu - Product Code	CA.10305
Koli Adedi - Box Pcs.	5

YENİ ÜRÜN  
NEW PRODUCT
**PRİZ ÇIKIŞ KUTUSU ALÜMİNYUM (8 MODÜL)**  
**SOCKET OUTLET BOX ALUMINUM (8 MODULES)**

Ürün Kodu - Product Code	CA.10303
Koli Adedi - Box Pcs.	22
Masa Kesim Ölçüsü	238 x 84 mm

YENİ ÜRÜN  
NEW PRODUCT
**120'LİK GROMET DÖŞEME ALTI PRİZ KUTUSU**  
**120-SIZE GROMET FLOOR SOCKET OUTLET BOX**

Ürün Kodu - Product Code	CA.10302
Koli Adedi - Box Pcs.	34
Montaj Ölçüsü	120 mm

YENİ ÜRÜN  
NEW PRODUCT
**120'LİK GROMET MASA TİPİ PRİZ KUTUSU**  
**120 GROMET TABLE TYPE SOCKET BOX**

Ürün Kodu - Product Code	CA.10304
Koli Adedi - Box Pcs.	34
Montaj Ölçüsü	120 mm

YENİ ÜRÜN  
NEW PRODUCT
**DÖŞEME ALTI GROMET 8 MODÜL + 4 KEYSTONE JACK**  
**UNDERFLOOR GROMET 8 MODULE + 4 KEYSTONE JACK**

Ürün Kodu - Product Code	CA.10302
Koli Adedi - Box Pcs.	1
Montaj Ölçüsü	150 x 137 mm

	KOD CODE	AÇIKLAMA DESCRIPTION	ADET QUANTITY	AMBALAJ PACKING
<p><b>YENİ ÜRÜN</b> NEW PRODUCT</p> 	AK 324	1 x 16A Kauçuk Topraklı Priz Grounded Female Plug Rubber	120	Kutu Box
<p><b>YENİ ÜRÜN</b> NEW PRODUCT</p> 	AK 325	3 x 25A Uzatma Priz Female Plug Rubber	120	Kutu Box
<p><b>YENİ ÜRÜN</b> NEW PRODUCT</p> 	AK 326	3 x 25A Trifaze Fiş 3 x 25 Male Plug Rubber	150	Kutu Box
<p><b>YENİ ÜRÜN</b> NEW PRODUCT</p> 	AK 327	1 x 16A Kauçuk Topraklı Düz Fiş Grounded Female Plug Rubber	240	Kutu Box
<p><b>YENİ ÜRÜN</b> NEW PRODUCT</p> 	AK 328	1 x 16A Kauçuk tekli Duvar Prizi Grounded Female Plug Rubber	120	Kutu Box
<p><b>YENİ ÜRÜN</b> NEW PRODUCT</p> 	AK 329	1 x 16A Kauçuk 2'li Grup Priz Double Group Socket	72	Kutu Box
<p><b>YENİ ÜRÜN</b> NEW PRODUCT</p> 	AK 330	1 x 16A Kauçuk 3'lü Grup Priz Triple Group Socket	48	Kutu Box



	KOD CODE	AÇIKLAMA DESCRIPTION	ADET QUANTITY	AMBALAJ PACKING
<b>YENİ ÜRÜN</b> NEW PRODUCT 	AK 424	3 x 25A Tekli Duvar Prizi Wall Installation Plug Single	Kutu Box	72
<b>YENİ ÜRÜN</b> NEW PRODUCT 	AK 425	3 x 25A 2'li Grup Priz Double Group Socket	Kutu Box	36
<b>YENİ ÜRÜN</b> NEW PRODUCT 	AK 426	3 x 25A 1 Adet 1 x 16A 1 Adet Grup Priz Double Group Socket	Kutu Box	36
<b>YENİ ÜRÜN</b> NEW PRODUCT 	AK 427	3 x 25A 3'lü Grup Priz Triple Group Socket	Kutu Box	36
<b>YENİ ÜRÜN</b> NEW PRODUCT 	AK 428	3 x 25A 2 Adet 1 x 16A Grup Priz Triple Group Socket	Kutu Box	36
<b>YENİ ÜRÜN</b> NEW PRODUCT 	AK 429	3 x 25A 1 Adet 1 x 16A 2 Adet Grup Priz Triple Group Socket	Kutu Box	36

# Buat ve Makaralarımızın teknik özellikleri

Technical Specification  
of Crane Switch Boxes  
and Cable Reels

**YENİ ÜRÜN**  
NEW PRODUCT



**YENİ ÜRÜN**  
NEW PRODUCT



**YENİ ÜRÜN**  
NEW PRODUCT



**YENİ ÜRÜN**  
NEW PRODUCT



**YENİ ÜRÜN**  
NEW PRODUCT



**YENİ ÜRÜN**  
NEW PRODUCT

**YENİ ÜRÜN**  
NEW PRODUCT



15 Mt.





25 Mt.



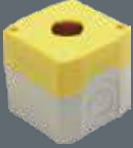

40 Mt.





50 Mt.

100 Mt.

YENİ ÜRÜNLER  
NEW PRODUCTS

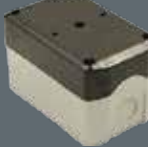
Emergency Push Button Box	Button Box For Single Button	Button Box For Double Button	Button Box For Triple Button	Button Box For Quad Button
				
AK3-1011-0002	AK3-1000-0002	AK3-2000-0002	AK3-3000-0002	AK3-4000-0002
CODE	DESCRIPTION	IP	BOX	PACK
<b>AK3-1011-0002</b>	Emergency Push Button Box (Yellow)	IP44	16	192
<b>AK3-1000-0002</b>	Button Box For Single Button (Black)	IP44	16	192
<b>AK3-2000-0002</b>	Button Box For Double Button (Black)	IP44	12	144
<b>AK3-3000-0002</b>	Button Box For Triple Button (Black)	IP44	8	96
<b>AK3-4000-0002</b>	Button Box For Quad Button (Black)	IP44	4	48

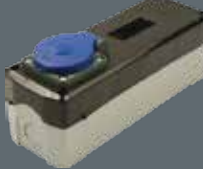
Emergency Push Button Box	Button Box For Single Button	Button Box For Double Button	Button Box For Triple Button	Button Box For Quad Button
				
AK3-1011-0006	AK3-1000-0006	AK3-2000-0006	AK3-3000-0006	AK3-4000-0006
CODE	DESCRIPTION	IP	BOX	PACK
<b>AK3-1011-0006</b>	Emergency Push Button Box (Yellow)	IP44	16	192
<b>AK3-1000-0006</b>	Button Box For Single Button (Black)	IP44	16	192
<b>AK3-2000-0006</b>	Button Box For Double Button (Black)	IP44	12	144
<b>AK3-3000-0006</b>	Button Box For Triple Button (Black)	IP44	8	96
<b>AK3-4000-0006</b>	Button Box For Quad Button (Black)	IP44	4	48

10A. Pacco Switch Box	25A. Pacco Switch Box	Fuse and Socket Box	1/16A. 220V. Fuse and with Socket Box	1/16A. 220V. Signal Fuse and with Socket Box
				
AK3-1020-0002	AK3-2030-0002	AK3-4040-0002	AK3-4050-0002	AK3-4060-0002
CODE	DESCRIPTION	IP	BOX	PACK
<b>AK3-1020-0002</b>	10A. Pacco Switch Box	IP44	16	192
<b>AK3-2030-0002</b>	25A. Pacco Switch Box	IP44	12	144
<b>AK3-4040-0002</b>	Fuse and Socket Box	IP44	4	48
<b>AK3-4050-0002</b>	1/16A. 220V. Fuse and with Socket Box	IP44	4	48
<b>AK3-4060-0002</b>	1/16A. 220V. Signal and with Socket Box	IP44	4	48

**YENİ ÜRÜNLER**  
 NEW PRODUCTS

CODE	DESCRIPTION	IP	BOX	PACK
<b>AK4-1001-0007</b>	Button Box For Single Button 80x80x60	IP67	1	65
<b>AK4-1001-0017</b>	Button Box For Single Button 80x80x73	IP67	1	45
<b>AK4-2001-0007</b>	Button Box For Double Button 80x130x73	IP67	1	35
<b>AK4-3001-0007</b>	Button Box For Triple Button 80x170x73	IP67	1	22
<b>AK4-3001-0017</b>	Button Box For Quad Button 80x170x73	IP67	1	22
<b>AK4-4001-0007</b>	Button Box For Quintet Button 80x230x73	IP67	1	15
<b>AK4-4001-0017</b>	Button Box For Six Button 80x230x73	IP67	1	15

CODE	DESCRIPTION	IP	BOX	PACK
<b>AK4-1071-0007</b>	Button Box For Single Button 80x80x60	IP67	1	65
<b>AK4-1071-0017</b>	Button Box For Single Button 80x80x73	IP67	1	45
<b>AK4-2071-0007</b>	Button Box For Double Button 80x130x73	IP67	1	35
<b>AK4-3071-0007</b>	Button Box For Triple Button 80x170x73	IP67	1	22
<b>AK4-3071-0017</b>	Button Box For Quad Button 80x170x73	IP67	1	22
<b>AK4-4071-0007</b>	Button Box For Quintet Button 80x230x73	IP67	1	15
<b>AK4-4071-0017</b>	Button Box For Six Button 80x230x73	IP67	1	15



Plastic

4 Pcs. 1/16A. 220V. Socket  
3x1,5mm TTR 25 Mt. Capacity  
Plastic Cable Reel



AK8

4 Pcs. 1/16A. 220V. Socket  
3x1,5mm TTR 25 Mt. Cable  
Plastic Cable Reel



AK8

4 Pcs. 1/16A. 220V. Socket  
3x1,5mm TTR 25 Mt. Capacity  
Thermal Fuse Plastic Cable Reel



AK8

4 Pcs. 1/16A. 220V. Socket  
3x1,5mm TTR 25 Mt. Cable  
Thermal Fuse Plastic Cable Reel



AK8

AK8-2103-0000

AK8K2103-0000

AK8-2104-0000

AK8K2104-0000

Plastic

4 Pcs. 1/16A. 220V. Socket  
3x1,5mm TTR 50 Mt. Capacity  
Plastic Cable Reel



AK9

4 Pcs. 1/16A. 220V. Socket  
3x1,5mm TTR 50 Mt. Cable  
Plastic Cable Reel



AK9

4 Pcs. 1/16A. 220V. Socket  
3x1,5mm TTR 50 Mt. Capacity  
Thermal Fuse Plastic Cable Reel



AK9

4 Pcs. 1/16A. 220V. Socket  
3x1,5mm TTR 50 Mt. Cable  
Thermal Fuse Plastic Cable Reel



AK9

AK9-3103-0000

AK9K3103-0000

AK9-3104-0000

AK9K3104-0000

Plastic

4 Pcs. 1/16A. 220V. Socket  
3x1,5mm TTR 15 Mt. Capacity  
Plastic Cable Reel



AK7

4 Pcs. 1/16A. 220V. Socket  
3x1,5mm TTR 15 Mt. Cable  
Plastic Cable Reel



AK7

3 Pcs. 1/16A. 220V. IP54 Socket  
3x1,5mm TTR 25 Mt. Capacity  
Thermal Fuse Plastic Cable Reel



AK8

IP54

3 Pcs. 1/16A. 220V. IP54 Socket  
3x1,5mm TTR 50 Mt. Capacity  
Thermal Fuse Plastic Cable Reel



AK9

IP54

AK7-1103-0000

AK7K1103-0000

AK8-2357-0004

AK9-3357-0004

Metal

Socketsiz Kulaklı Kapaklı  
3x1,5mm TTR 25 Mt. Capacity Metal  
Cable Reel



AM1

4 Pcs. 1/16A. 220V. Socket  
3x1,5mm TTR 25 Mt. Capacity  
Metal Cable Reel



AM1

4 Pcs. 1/16A. 220V. Socket  
3x1,5mm TTR 25 Mt. Cable  
Metal Cable Reel



AM1

3x1,5mm TTR 50 Mt. Capacity with  
Protection Cover Metal Cable Reel



AM2

AM1-2102-0000

AM1-2103-0000

AM1K2103-0000

AM2-3102-0000

Metal

4 Pcs. 1/16A. 220V. Socket  
3x1,5mm TTR 50 Mt. Capacity  
Metal Cable Reel



AM2

4 Pcs. 1/16A. 220V. Socket  
3x1,5mm TTR 50 Mt. Cable  
Metal Cable Reel



AM2

4 Pcs. 1/16A. 220V. Socket  
3x2,5mm TTR 25 Mt. Cable  
Metal Cable Reel



AM2

AM2-3103-0000

AM2K3103-0000

AM2K3103-0022

**YENİ ÜRÜNLER**  
 NEW PRODUCTS

Metal

 3x2,5mm TTR 50 Mt.  
 Capacity with Protection Cover  
 Metal Cable Reel

AK3

AK3-4102-0000

 4 Pcs. 1/16A. 220V. Socket  
 3x2,5mm TTR 50 Mt. Capacity Metal  
 Cable Reel

AK3

AK3-4403-0000

 3 Pcs. 1/16A. 220V. Socket  
 3x2,5mm TTR 50 Mt. Capacity  
 Metal Cable Reel

AK3

AK3-4303-0000

Metal

 5x2,5mm TTR 40 Mt.  
 Capacity Metal Cable Reel

AK4

AK4-5000-0000

 5x2,5mm TTR 40 Mt.  
 Capacity with Protection Cover  
 Metal Cable Reel

AK4

AK4-5102-0000

 6 Pcs. 1/16A. 220V. Socket  
 5x2,5mm TTR 40 Mt. Capacity  
 Metal Cable Reel

AK4

AK4-5603-0000

 2 Pcs. 1/16A. 220V. 1 Pc. 3/25A. 380V.  
 Socket 5x2,5mm TTR 40 Mt.  
 Capacity Metal Cable Reel

AK4

AK4-5203-1060

Metal

 5x2,5mm TTR 50 Mt.  
 Capacity Metal Cable Reel

AK5

AK5-6000-0000

 4 Pcs. 1/16A. 220V. IP67 Socket  
 5x2,5mm TTR 50 Mt. Capacity  
 Metal Cable Reel

AK5

AK5-6431-0000

 2 Pcs. 1/16A. 220V. 1 Pc. 5/32A. 380V.  
 1 Pc. 5/16A. 380V. IP67 Socket 5x2,5mm  
 TTR 50 Mt. Capacity Metal Cable Reel

AK5

AK5-6231-1611

 3 Pcs. 1/16A. 220V. Socket  
 5x2,5mm TTR 50 Mt. Capacity  
 Metal Cable Reel

AK5

AK5-6303-0000

Metal

 Socketsiz 5x2,5mm TTR 100 Mt.  
 Capacity Portable  
 Metal Cable Reel

AK6

AK6-7000-0000

 3 Pcs. 1/16A. 220V. Socket  
 5x2,5mm TTR 100 Mt. Capacity  
 Portable Metal Cable Reel

AK6

AK6-7303-0000

 2 Pcs. 1/16A. 220V. 2 Pcs. 5/32A. 380V.  
 IP67 Socket 5x2,5mm TTR 100 Mt.  
 Capacity Portable Metal Cable Reel

AK6

AK6-7231-2610

 4 Pcs. 1/16A. 220V. IP67 Socket  
 5x2,5mm TTR 100 Mt. Capacity  
 Portable Metal Cable Reel

AK6

AK6-7431-0000



**CEE Norm 3/16A. (2P+E) 220V. 50/60 Hz. 6h**

PRODUCT CODE	DESCRIPTION	IP	BOX	PACK
AC1-1403-2011	3/16A. Straight Plug	IP44	10	180
AC1-1403-2312	3/16A. Connector Socket	IP44	10	180
AC1-1403-2413	3/16A. Panel Mounted Socket	IP44	15	180
AC1-1403-2114	3/16A. Panel Mounted Plug	IP44	10	180
AC1-1403-2130	3/16A. 90° Angled Rotate Plug	IP44	6	108
AC1-1403-2210	3/16A. Surface Mounted Plug	IP44	6	108
AC1-1403-2236	3/16A. 90° Angled Surface Plug with Cover	IP44	6	72
AC1-1403-2235	3/16A. 90° Angled Surface Plug	IP44	6	72
AC1-1403-2535	3/16A. 90° Angled Surface Socket	IP44	3	54
AC1-1403-2420	3/16A. 45° Angled Panel Mounted Socket	IP44	8	144
AC1-1403-2510	Surface Mounted Socket	IP44	6	108

PRODUCT CODE	DESCRIPTION	IP	BOX	PACK
AC1-1403-7011	3/16A. Straight Plug	IP67	8	144
AC1-1403-7312	3/16A. Connector Socket	IP67	8	144
AC1-1403-7413	3/16A. Panel Mounted Socket	IP67	8	144
AC1-1403-7114	3/16A. Panel Mounted Plug	IP67	10	180
AC1-1403-7210	3/16A. Surface Mounted Plug	IP67	4	72
AC1-1403-7236	3/16A. 90° Angled Surface Plug	IP67	3	54
AC1-1403-7420	3/16A. 45° Angled Panel Mounted Socket	IP67	6	108
AC1-1403-7510	3/16A. Surface Mounted Socket	IP67	4	72
AC1-1403-7535	3/16A. 90° Angled Surface Socket	IP67	3	54



**CEE Norm 4/16A. (3P+E) 380V. 50/60 Hz. 6h**

PRODUCT CODE	DESCRIPTION	IP	BOX	PACK
AC1-1504-2011	4/16A. Straight Plug	IP44	8	144
AC1-1504-2312	4/16A. Connector Socket	IP44	8	144
AC1-1504-2413	4/16A. Panel Mounted Socket	IP44	15	180
AC1-1504-2114	4/16A. Panel Mounted Plug	IP44	10	180
AC1-1504-2130	4/16A. 90° Angled Rotate Plug	IP44	6	108
AC1-1504-2210	4/16A. Surface Mounted Plug	IP44	6	108
AC1-1504-2236	4/16A. 90° Angled Surface Plug	IP44	6	72
AC1-1504-2235	4/16A. 90° Angled Surface Plug with Cover	IP44	6	72
AC1-1504-2535	4/16A. 90° Angled Surface Socket	IP44	3	54
AC1-1504-2420	4/16A. 45° Angled Panel Mounted Socket	IP44	8	144
AC1-1504-2510	4/16A. Surface Mounted Socket	IP44	6	108
AR1-1504-2711	Rail Socket	IP20	6	72

PRODUCT CODE	DESCRIPTION	IP	BOX	PACK
AC1-1504-7011	4/16A. Straight Plug	IP67	6	108
AC1-1504-7312	4/16A. Connector Socket	IP67	6	108
AC1-1504-7413	4/16A. Panel Mounted Socket	IP67	8	144
AC1-1504-7114	4/16A. Panel Mounted Plug	IP67	10	180
AC1-1504-7210	4/16A. Surface Mounted Plug	IP67	4	72
AC1-1504-7236	4/16A. 90° Angled Surface Plug	IP67	3	54
AC1-1504-7420	4/16A. 45° Angled Panel Mounted Socket	IP67	6	108
AC1-1504-7510	4/16A. Surface Mounted Socket	IP67	4	72
AC1-1504-7535	4/16A. 90° Angled Surface Socket	IP67	3	54







### CEE Norm 5/16A. (3P+E+N) 380V. 50/60 Hz. 6h

PRODUCT CODE	DESCRIPTION	IP	BOX	PACK
AC1-1505-2011	5/16A. Straight Plug	IP44	8	144
AC1-1505-2312	5/16A. Connector Socket	IP44	8	144
AC1-1505-2413	5/16A. Panel Mounted Socket (75x75)	IP44	15	180
AC1-1505-2114	5/16A. Panel Mounted Plug	IP44	8	144
AC1-1505-2140	5/16A. Screwless Connection Plug	IP44	8	96
AC1-1505-2130	5/16A. 90° Angled Rotate Plug	IP44	6	108
AC1-1505-2210	5/16A. Surface Mounted Plug	IP44	6	108
AC1-1505-2236	5/16A. 90° Angled Surface Plug	IP44	3	54
AC1-1505-2235	5/16A. 90° Angled Surface Plug with Cover	IP44	3	54
AC1-1505-2420	5/16A. 45° Angled Panel Mounted Socket	IP44	6	108
AC1-1505-2440	5/16A. Screwless Connection Socket	IP44	8	96
AC1-1505-2510	5/16A. Surface Mounted Socket	IP44	6	108
AC1-1505-2535	5/16A. 90° Angled Surface Socket	IP44	3	54
AC1-1505-2537	5/16A. 90° Angled Surface Plug with Schuko	IP44	3	36
AC1-1505-2050	5/16A. Inverter Straight Plug	IP44	8	96
AC1-1505-2070	5/16A. Inverter Panel Mounted Plug	IP44	8	144
AC1-1505-2080	5/16A. 90° Angled Inverter Rotate Plug	IP44	6	108
AC1-1505-2060	5/16A. 90° Angled Inverter Surface Plug	IP44	3	54
AC1-1505-2061	5/16A. 90° Angled Inverter Surface Plug with Cover	IP44	3	54
AR1-1505-2711	5/16A. Rail Socket	IP20	6	72

PRODUCT CODE	DESCRIPTION	IP	BOX	PACK
AC1-1505-7011	5/16A. Straight Plug	IP67	4	72
AC1-1505-7312	5/16A. Connector Socket	IP67	4	72
AC1-1505-7413	5/16A. Panel Mounted Socket (75x75)	IP67	6	108
AC1-1505-7114	5/16A. Panel Mounted Plug	IP67	6	108
AC1-1505-7210	5/16A. Surface Mounted Plug	IP67	4	72
AC1-1505-7236	5/16A. 90° Angled Surface Plug	IP67	3	54
AC1-1505-7420	5/16A. 45° Angled Panel Mounted Socket	IP67	6	108
AC1-1505-7440	5/16A. Screwless Connection Socket	IP67	6	108
AC1-1505-7510	5/16A. Surface Mounted Socket	IP67	4	72
AC1-1505-7535	5/16A. 90° Angled Surface Socket	IP67	3	54
AC1-1505-7050	5/16A. Inverter Straight Plug	IP67	4	72
AC1-1505-7070	5/16A. Inverter Panel Mounted Plug	IP67	6	108
AC1-1505-7060	5/16A. 90° Angled Inverter Surface Mounted Plug	IP67	3	54





**CEE Norm 4/32A. (3P+E) 380V. 50/60 Hz. 6h**

PRODUCT CODE	DESCRIPTION	IP	BOX	PACK
AC1-3504-2011	4/32A. Straight Plug	IP44	8	96
AC1-3504-2312	4/32A. Connector Socket	IP44	8	96
AC1-3504-2413	4/32A. Panel Mounted Socket (75x75)	IP44	8	96
AC1-3504-2114	4/32A. Panel Mounted Plug	IP44	8	144
AC1-3504-2140	4/32A. Screwless Connection Plug	IP44	8	96
AC1-3504-2130	4/32A. 90° Angled Rotate Plug	IP44	6	108
AC1-3504-2210	4/32A. Surface Mounted Plug	IP44	6	108
AC1-3504-2236	4/32A. 90° Angled Surface Plug	IP44	3	54
AC1-3504-2235	4/32A. 90° Angled Surface Plug with Cover	IP44	3	54
AC1-3504-2238	4/32A. 90° Angled Surface Plug with Schuko	IP44	3	36
AC1-3504-2420	4/32A. 45° Angled Panel Mounted Socket	IP44	6	108
AC1-3504-2440	4/32A. Screwless Connection Socket	IP44	8	96
AC1-3504-2510	4/32A. Surface Mounted Socket	IP44	6	108
AC1-3504-2535	4/32A. 90° Angled Surface Socket	IP44	3	54
AC1-3504-2537	4/32A. 90° Angled Surface Socket with Schuko	IP44	3	36

PRODUCT CODE	DESCRIPTION	IP	BOX	PACK
AC1-3504-7011	4/32A. Straight Plug	IP67	3	54
AC1-3504-7312	4/32A. Connector Socket	IP67	3	54
AC1-3504-7413	4/32A. Panel Mounted Socket (83x90)	IP67	4	72
AC1-3504-7114	4/32A. Panel Mounted Plug	IP67	6	108
AC1-3504-7210	4/32A. Surface Mounted Plug	IP67	2	24
AC1-3504-7236	4/32A. 90° Angled Surface Plug	IP67	3	54
AC1-3504-7238	4/32A. 90° Angled Surface Plug with Schuko	IP67	1	18
AC1-3504-7420	4/32A. 45° Angled Panel Mounted Socket	IP67	4	72
AC1-3504-7440	4/32A. Screwless Connection Socket	IP67	4	72
AC1-3504-7510	4/32A. Surface Mounted Socket	IP67	2	36
AC1-3504-7535	4/32A. 90° Angled Surface Socket	IP67	3	54
AC1-3504-7537	4/32A. 90° Angled Surface Socket with Schuko	IP67	1	18





### CEE Norm 5/32A. (3P+E+N) 380V. 50/60 Hz. 6h

PRODUCT CODE	DESCRIPTION	IP	BOX	PACK
AC1-3505-2011	5/32A. Straight Plug	IP44	8	96
AC1-3505-2312	5/32A. Connector Socket	IP44	8	96
AC1-3505-2413	5/32A. Panel Mounted Socket (75x75)	IP44	8	96
AC1-3505-2114	5/32A. Panel Mounted Plug	IP44	8	144
AC1-3505-2140	5/32A. Screwless Connection Plug	IP44	8	96
AC1-3505-2130	5/32A. 90° Angled Rotate Plug	IP44	6	108
AC1-3505-2210	5/32A. Surface Mounted Plug	IP44	6	108
AC1-3505-2236	5/32A. 90° Angled Surface Plug	IP44	3	54
AC1-3505-2235	5/32A. 90° Angled Surface Plug with Cover	IP44	3	54
AC1-3505-2238	5/32A. 90° Angled Surface Plug with Schuko	IP44	3	36
AC1-3505-2420	5/32A. 45° Angled Panel Mounted Socket	IP44	6	108
AC1-3505-2440	5/32A. Screwless Connection Socket	IP44	8	96
AC1-3505-2510	5/32A. Surface Mounted Socket	IP44	6	108
AC1-3505-2535	5/32A. 90° Angled Surface Socket	IP44	3	54
AC1-3505-2537	5/32A. 90° Angled Surface Socket with Schuko	IP44	3	36
AC1-3505-2050	5/32A. Inverter Straight Plug	IP44	8	96
AC1-3505-2070	5/32A. Inverter Panel Mounted Plug	IP44	8	144
AC1-3505-2080	5/32A. 90° Angled Inverter Rotate Plug	IP44	6	108
AC1-3505-2060	5/32A. 90° Angled Inverter Surface Mounted Plug	IP44	3	54
AC1-3505-2061	5/32A. 90° Angled Inverter Surface Mounted Plug with Cover	IP44	3	54

PRODUCT CODE	DESCRIPTION	IP	BOX	PACK
AC1-3505-7011	5/32A. Straight Plug	IP67	3	5
AC1-3505-7312	5/32A. Connector Socket	IP67	3	454
AC1-3505-7413	5/32A. Panel Mounted Socket (75x75)	IP67	4	72
AC1-3505-7114	5/32A. Panel Mounted Plug	IP67	6	108
AC1-3505-7210	5/32A. Surface Mounted Plug	IP67	2	24
AC1-3505-7236	5/32A. 90° Angled Surface Plug	IP67	3	54
AC1-3505-7238	5/32A. 90° Angled Surface Plug with Schuko	IP67	1	18
AC1-3505-7420	5/32A. 45° Angled Panel Mounted Socket	IP67	4	72
AC1-3505-7440	5/32A. Screwless Connection Socket	IP67	4	72
AC1-3505-7510	5/32A. Surface Mounted Socket	IP67	2	36
AC1-3505-7535	5/32A. 90° Angled Surface Socket	IP67	3	54
AC1-3505-7537	5/32A. 90° Angled Surface Socket with Schuko	IP67	1	18
AC1-3505-7050	5/32A. Inverter Straight Plug	IP67	3	54
AC1-3505-7070	5/32A. Inverter Panel Mounted Plug	IP67	6	108
AC1-3505-7060	5/32A. 90° Angled Inverter Surface Mounted Plug	IP67	3	54



## CEE Norm 4/63A. (3P+E) 380V. 50/60 Hz. 6h

PRODUCT CODE	DESCRIPTION	IP	BOX	PACK
AC1-4504-2011	4/63A. Straight Plug (RS)	IP44	1	12
AC1-4504-2312	4/63A. Connector Socket (RS)	IP44	1	12
AC1-4504-2413	4/63A. Panel Mounted Socket (RS)	IP44	1	24
AC1-4504-2114	4/63A. Panel Mounted Plug (RS)	IP44	1	24
AC1-4504-2420	4/63A. 45° Angled Panel Mounted Socket (RS)	IP44	1	24
AC1-4504-2510	4/63A. Surface Mounted Socket (RS)	IP44	1	12
AC1-4504-2535	4/63A. 90° Angled Surface Socket (RS)	IP44	1	12
AC1-4504-2537	4/63A. 90° Angled Surface Socket with Schuko (RS)	IP44	1	12
AC1-4504-2210	4/63A. Surface Mounted Plug (RS)	IP44	1	12
AC1-4504-2236	4/63A. 90° Angled Surface Plug (RS)	IP44	1	12
AC1-4504-2238	4/63A. 90° Angled Surface Plug with Schuko (RS)	IP44	1	12

PRODUCT CODE	DESCRIPTION	IP	BOX	PACK
AC1-4504-7011	4/63A. Straight Plug (RS)	IP67	1	12
AC1-4504-7312	4/63A. Connector Socket (RS)	IP67	1	12
AC1-4504-7413	4/63A. Panel Mounted Socket (RS)	IP67	1	24
AC1-4504-7114	4/63A. Panel Mounted Plug (RS)	IP67	1	24
AC1-4504-7420	4/63A. 45° Angled Panel Mounted Socket (RS)	IP67	1	24
AC1-4504-7510	4/63A. Surface Mounted Socket (RS)	IP67	1	12
AC1-4504-7535	4/63A. 90° Angled Surface Socket (RS)	IP67	1	12
AC1-4504-7537	4/63A. 90° Angled Surface Socket with Schuko (RS)	IP67	1	12
AC1-4504-7210	4/63A. Surface Mounted Plug (RS)	IP67	1	12
AC1-4504-7236	4/63A. 90° Angled Surface Plug (RS)	IP67	1	12
AC1-4504-7238	4/63A. 90° Angled Surface Plug with Schuko (RS)	IP67	1	12





CEE Norm 5/63A. (3P+E+N) 380V. 50/60 Hz. 6h					
PRODUCT CODE	DESCRIPTION	IP	BOX	PACK	
AC1-4505-2011	5/63A. Straight Plug (RS)	IP44	1	12	
AC1-4505-2312	5/63A. Connector Socket (RS)	IP44	1	12	
AC1-4505-2413	5/63A. Panel Mounted Socket (RS)	IP44	1	24	
AC1-4505-2114	5/63A. Panel Mounted Plug (RS)	IP44	1	24	
AC1-4505-2420	5/63A. 45° Angled Panel Mounted Socket (RS)	IP44	1	24	
AC1-4505-2510	5/63A. Surface Mounted Socket (RS)	IP44	1	12	
AC1-4505-2535	5/63A. 90° Angled Surface Socket (RS)	IP44	1	12	
AC1-4505-2537	5/63A. 90° Angled Surface Socket with Schuko (RS)	IP44	1	12	
AC1-4505-2210	5/63A. Surface Mounted Plug (RS)	IP44	1	12	
AC1-4505-2236	5/63A. 90° Angled Surface Plug (RS)	IP44	1	12	
AC1-4505-2238	5/63A. 90° Angled Surface Plug with Schuko (RS)	IP44	1	12	

PRODUCT CODE	DESCRIPTION	IP	BOX	PACK	
AC1-4505-7011	5/63A. Straight Plug (RS)	IP67	1	12	
AC1-4505-7312	5/63A. Connector Socket (RS)	IP67	1	12	
AC1-4505-7413	5/63A. Panel Mounted Socket (RS)	IP67	1	24	
AC1-4505-7114	5/63A. Panel Mounted Plug (RS)	IP67	1	24	
AC1-4505-7420	5/63A. 45° Angled Panel Mounted Socket (RS)	IP67	1	24	
AC1-4505-7510	5/63A. Surface Mounted Socket (RS)	IP67	1	12	
AC1-4505-7535	5/63A. 90° Angled Surface Socket (RS)	IP67	1	12	
AC1-4505-7537	5/63A. 90° Angled Surface Socket with Schuko (RS)	IP67	1	12	
AC1-4505-7210	5/63A. Surface Mounted Plug (RS)	IP67	1	12	
AC1-4505-7236	5/63A. 90° Angled Surface Plug (RS)	IP67	1	12	
AC1-4505-7238	5/63A. 90° Angled Surface Plug with Schuko (RS)	IP67	1	12	





**CEE Norm 5/125A. (3P+E+N) 380V. 50/60 Hz. 6h**

PRODUCT CODE	DESCRIPTION	IP	BOX	PACK
<b>AC1-6505-7011</b>	5/125A. Straight Plug <i>(RS)</i>	IP67	1	8
<b>AC1-6505-7312</b>	5/125A. Connector Socket <i>(RS)</i>	IP67	1	8
<b>AC1-6505-7413</b>	5/125A. Panel Mounted Socket <i>(RS)</i>	IP67	1	8
<b>AC1-6505-7114</b>	5/125A. Panel Mounted Plug <i>(RS)</i>	IP67	1	8
<b>AC1-6505-7420</b>	5/125A. 45° Angled Panel Mounted Socket <i>(RS)</i>	IP67	1	8
<b>AC1-6505-7236</b>	5/125A. 90° Angled Surface Plug <i>(RS)</i>	IP67	1	12
<b>AC1-6505-7535</b>	5/125A. 90° Angled Surface Socket <i>(RS)</i>	IP67	1	12
<b>AC1-6505-7238</b>	5/125A. 90° Angled Plug Socket with Schuko <i>(RS)</i>	IP67	1	12
<b>AC1-6505-7537</b>	5/125A. 90° Angled Surface Socket with Schuko <i>(RS)</i>	IP67	1	12
<b>AC1-6505-7240</b>	5/125A. 90° Angled Surface Plug Pako Switch <i>(RS)</i>	IP67	1	12
<b>AC1-6505-7550</b>	5/125A. 90° Angled Surface Socket with Pako Switch <i>(RS)</i>	IP67	1	12

**CEE Norm 5/125A. (3P+E+N) 380V. 50/60 Hz. 6h  
PILOT CONTACT**

PRODUCT CODE	DESCRIPTION	IP	BOX	PACK
<b>AC3-6505-7011</b>	5/125A. Straight Plug <i>(RS)</i>	IP67	1	8
<b>AC3-6505-7312</b>	5/125A. Connector Socket <i>(RS)</i>	IP67	1	8
<b>AC3-6505-7413</b>	5/125A. Panel Mounted Socket <i>(RS)</i>	IP67	1	8
<b>AC3-6505-7114</b>	5/125A. Panel Mounted Plug <i>(RS)</i>	IP67	1	8
<b>AC3-6505-7420</b>	5/125A. 45° Angled Panel Mounted Socket <i>(RS)</i>	IP67	1	8
<b>AC3-6505-7236</b>	5/125A. 90° Angled Surface Plug <i>(RS)</i>	IP67	1	12
<b>AC3-6505-7535</b>	5/125A. 90° Angled Surface Socket <i>(RS)</i>	IP67	1	12
<b>AC3-6505-7238</b>	5/125A. 90° Angled Plug Socket with Schuko <i>(RS)</i>	IP67	1	12
<b>AC3-6505-7537</b>	5/125A. 90° Angled Surface Socket with Schuko <i>(RS)</i>	IP67	1	12
<b>AC3-6505-7240</b>	5/125A. 90° Angled Surface Plug Pako Switch <i>(RS)</i>	IP67	1	12
<b>AC3-6505-7550</b>	5/125A. 90° Angled Surface Socket with Pako Switch <i>(RS)</i>	IP67	1	12





# Borularımızın teknik özellikleri

Technical Specifications  
for our Spirals

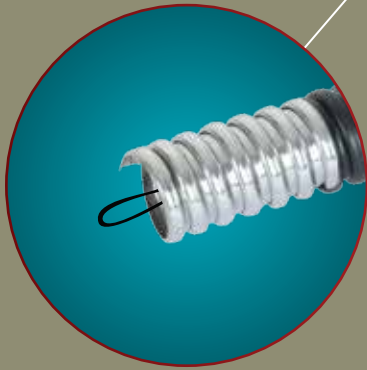

Kılavuz Telli  
With Guide Wire

Ağır Hizmet Tipi Boru  
Heavy Duty Pipe

**YENİ ÜRÜN**  
NEW PRODUCT

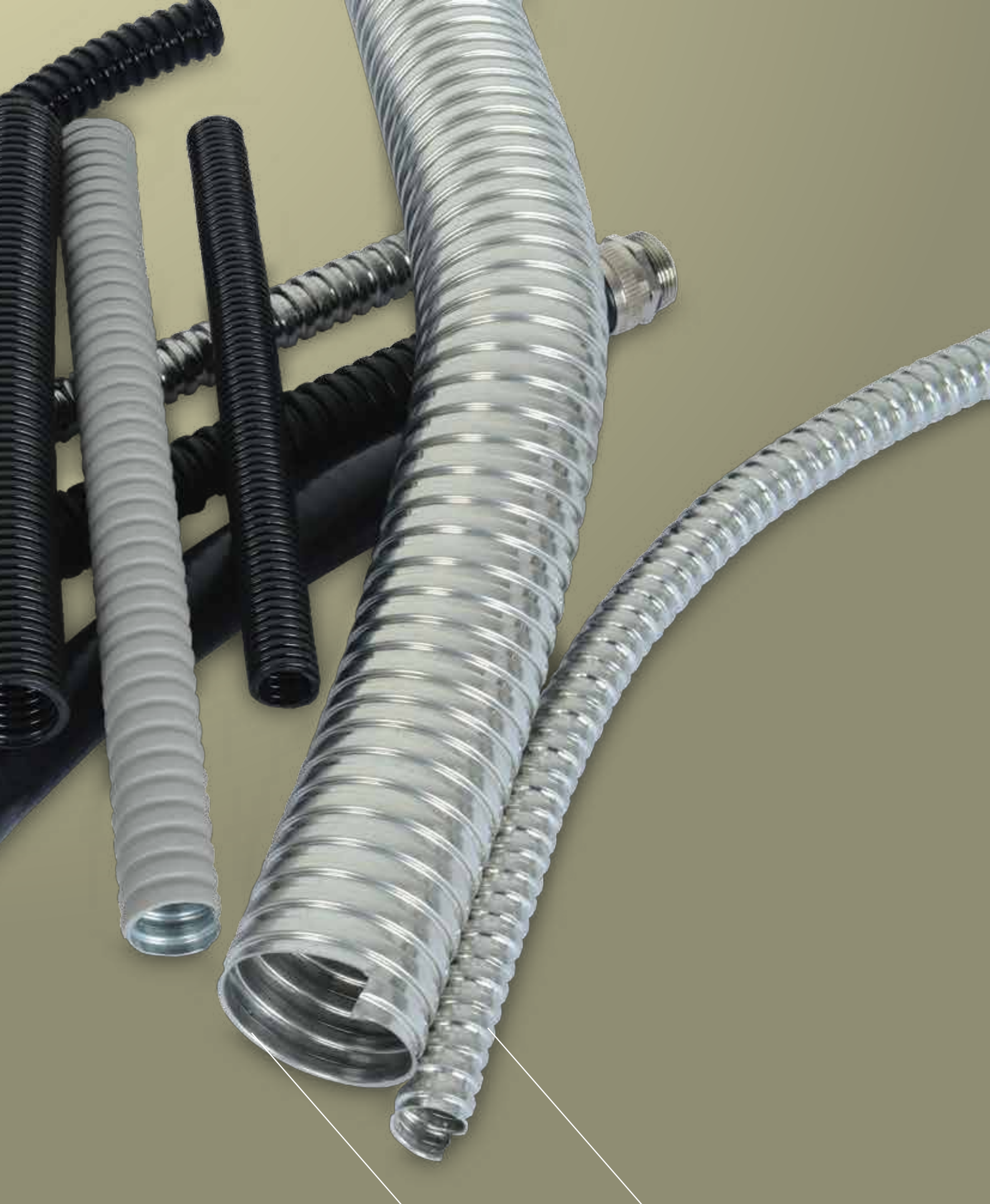

Çelik  
Steel

Golvaniz

## PVC Düz Boru 3m PVC Rigid Conduit Hafif Seri / Light Gauge



Alev Yayımayan  
Yayıla Bükülebilen

Self Extinguishing  
Malleable Rigid Conduit

Ürün Renkleri - Product Colors



Gri Grey  
Siyah Black

KOD CODE	DIŞ ÇAP (MM) EX. DIAMETER (MM)	İÇ ÇAP (MM) INT. DIAMETER (MM)	AMBALAJ PACKAGING
<b>AK 10121</b>	Ø 16	14,5	102 m
<b>AK 10122</b>	Ø 20	17,5	102 m
<b>AK 10123</b>	Ø 25	22,1	51 m
<b>AK 10124</b>	Ø 32	29,2	45 m

 **320 Newton**

TEKNİK ÖZELLİKLER		TECHNICAL SPECIFICATIONS	
Standart	: EN 61386-21 / 22	Standart	: En 61386-21 / 22
Malzeme	: PVC Bazlı Termoplastik	Material	: PVC Based Thermoplastic
Sıkıştırma Dayanımı	: 320 Newton / 60 sn./sec / 23 +2°C	Compression Resistance	: 320 Newton / 60 sn./sec / 23 +2°C
Darbe Dayanımı	: 1 kg. / 100 mm / -25°C	Impact Resistance	: 1 kg. / 100 mm / -25°C
Çalışma Ortamı Sıcaklığı	: -25°C + 60°C	Working Temperature	: -25°C + 60°C
Yalıtım Gerilimi	: 2000 V/50 H. / 15 dak.	Insulating Strength	: 2000 V/50 Hz. / 15 min.
Kendiliğinden Sönen PVC Malzeme	: UL94 V0	PVC Material (Self Extinguishing)	: UL94 V0
Boru Boyu	: 3 m	Conduit Length	: 3 m



### PP SPİRAL BORU REKORU - HALOJEN FREE (RECORD)

ANMA ÇAPI	Ø 16	Ø 20	Ø 25	Ø 32
AMBALAJ - PCS.	100	100	100	100
KOD - CODE	AKK - 16 - PP	AKR - 20 - PP	AKR - 25 - PP	AKR - 32 - PP



### PP DİRSEK - HALOJEN FREE (ELBOW)

ANMA ÇAPI	Ø 16	Ø 20	Ø 25	Ø 32
AMBALAJ - PCS.	100	100	100	100
KOD - CODE	AKD - 16 - PP	AKD - 20 - PP	AKD - 25 - PP	AKD - 32 - PP



### PP AÇILIR DİRSEK - HALOJEN FREE

ANMA ÇAPI	Ø 16	Ø 20	Ø 25	Ø 32
AMBALAJ - PCS.	25	25	25	15
KOD - CODE	AKA - 16 - PP	AKA - 20 - PP	AKA - 25 - PP	AKA - 32 - PP



### PP T BAĞLANTI - HALOJEN FREE

ANMA ÇAPI	Ø 16	Ø 20	Ø 25	Ø 32
AMBALAJ - PCS.	100	100	100	100
KOD - CODE	AKT - 16 - PP	AKT - 20 - PP	AKT - 25 - PVC	AKT - 32 - PP

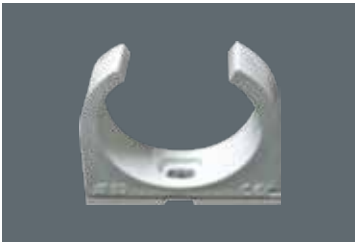

### PP SPİRAL BORU REKORU - HALOJEN FREE

ANMA ÇAPI	Ø 16	Ø 20	Ø 25	Ø 32
AMBALAJ - PCS.	50	50	50	25
KOD - CODE	AKS - 16 - PP	AKS - 25 - PP	AKS - 25 - PP	AKS - 32 - PP

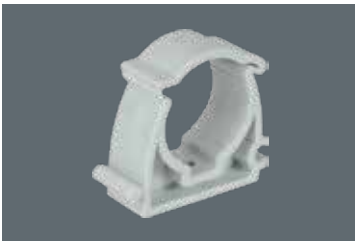

### PP KAPAKLI KROŞE - HALOJEN FREE

ANMA ÇAPI	Ø 16	Ø 20	Ø 25	Ø 32
AMBALAJ - PCS.	100	100	100	100
KOD - CODE	AKK - 16 - PP	AKK - 20 - PP	AKK - 25 - PP	AKK - 32 - PP



### PVC ESNEK MUF - HALOJEN FREE

ANMA ÇAPI	Ø 16	Ø 20	Ø 25	Ø 32
AMBALAJ - PCS.	70	20	10	10
KOD - CODE	AKM - 16 - PVC	AKM - 20 - PVC	AKM - 25 - PVC	AKM - 32 - PVC



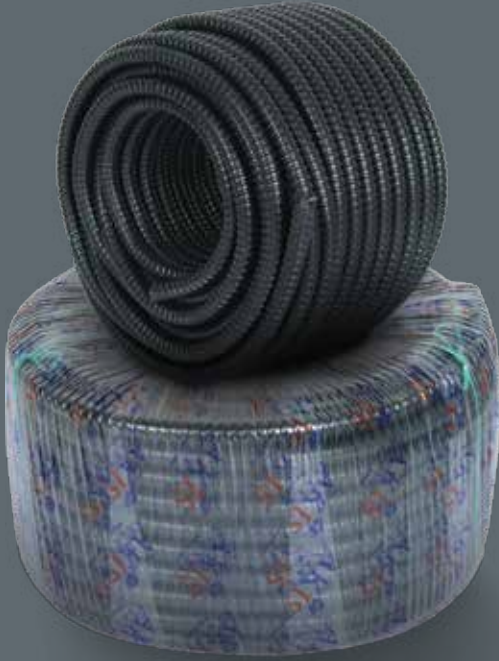

## PVC İZOLELİ ÇELİK SİRİL BORU PVC INSULATED STEEL SPIRAL CONDUIT

KOD CODE	ÜRÜN ADI PRODUCT NAME	MT. PACK
APS - ICS 9	9 mm İzoleli Çelik SİRİL Boru 9 mm Insulated Steel Spirals	50
APS - ICS 11	11 mm İzoleli Çelik SİRİL Boru 11 mm Insulated Steel Spirals	50
APS - ICS 14	14 mm İzoleli Çelik SİRİL Boru 14 mm Insulated Steel Spirals	50
APS - ICS 16	16 mm İzoleli Çelik SİRİL Boru 16 mm Insulated Steel Spirals	50
APS - ICS 18	18 mm İzoleli Çelik SİRİL Boru 18 mm Insulated Steel Spirals	50
APS - ICS 21	21 mm İzoleli Çelik SİRİL Boru 21 mm Insulated Steel Spirals	50
APS - ICS 26	26 mm İzoleli Çelik SİRİL Boru 26 mm Insulated Steel Spirals	25
APS - ICS 29	29 mm İzoleli Çelik SİRİL Boru 29 mm Insulated Steel Spirals	25
APS - ICS 32	32 mm İzoleli Çelik SİRİL Boru 32 mm Insulated Steel Spirals	25
APS - ICS 35	35 mm İzoleli Çelik SİRİL Boru 35 mm Insulated Steel Spirals	25
APS - ICS 37	37 mm İzoleli Çelik SİRİL Boru 37 mm Insulated Steel Spirals	25
APS - ICS 40	40 mm İzoleli Çelik SİRİL Boru 40 mm Insulated Steel Spirals	25
APS - ICS 42	42 mm İzoleli Çelik SİRİL Boru 42 mm Insulated Steel Spirals	25
APS - ICS 45	45 mm İzoleli Çelik SİRİL Boru 45 mm Insulated Steel Spirals	25
APS - ICS 50	50 mm İzoleli Çelik SİRİL Boru 50 mm Insulated Steel Spirals	25

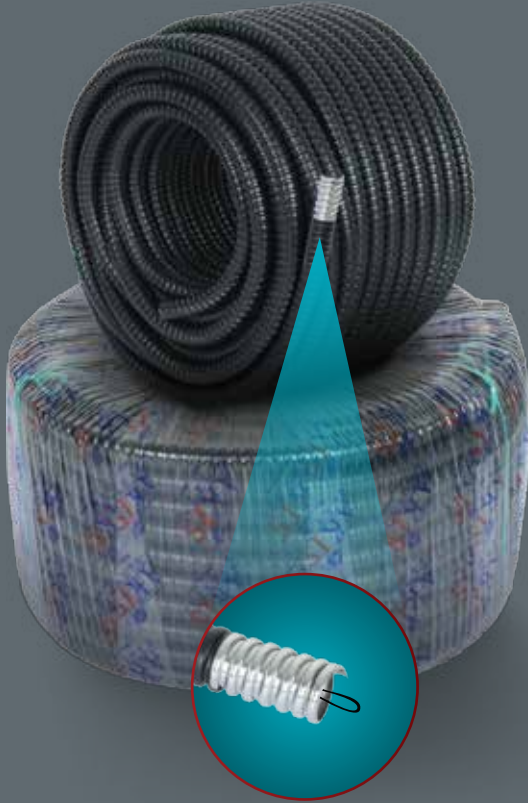

## KILAVUZ TELLİ İZOLELİ ÇELİK SİRİL BORU PVC INSULATED STEEL SPIRAL CONDUIT WITH GUIDE

KOD CODE	ÜRÜN ADI PRODUCT NAME	MT. PACK
APS - ICST 9	9 mm İzoleli Çelik SİRİL Boru Telli 9 mm Insulated Steel Spirals Conduit With Guide	50
APS - ICST 11	11 mm İzoleli Çelik SİRİL Boru Telli 11 mm Insulated Steel Spirals Conduit With Guide	50
APS - ICST 14	14 mm İzoleli Çelik SİRİL Boru Telli 14 mm Insulated Steel Spirals Conduit With Guide	50
APS - ICST 16	16 mm İzoleli Çelik SİRİL Boru Telli 16 mm Insulated Steel Spirals Conduit With Guide	50
APS - ICST 18	18 mm İzoleli Çelik SİRİL Boru Telli 18 mm Insulated Steel Spirals Conduit With Guide	50
APS - ICST 21	21 mm İzoleli Çelik SİRİL Boru Telli 21 mm Insulated Steel Spirals Conduit With Guide	50
APS - ICST 26	26 mm İzoleli Çelik SİRİL Boru Telli 26 mm Insulated Steel Spirals Conduit With Guide	25
APS - ICST 29	29 mm İzoleli Çelik SİRİL Boru Telli 29 mm Insulated Steel Spirals Conduit With Guide	25
APS - ICST 32	32 mm İzoleli Çelik SİRİL Boru Telli 32 mm Insulated Steel Spirals Conduit With Guide	25
APS - ICST 35	35 mm İzoleli Çelik SİRİL Boru Telli 35 mm Insulated Steel Spirals Conduit With Guide	25
APS - ICST 37	37 mm İzoleli Çelik SİRİL Boru Telli 37 mm Insulated Steel Spirals Conduit With Guide	25
APS - ICST 40	40 mm İzoleli Çelik SİRİL Boru Telli 40 mm Insulated Steel Spirals Conduit With Guide	25
APS - ICST 42	42 mm İzoleli Çelik SİRİL Boru Telli 42 mm Insulated Steel Spirals Conduit With Guide	25
APS - ICST 45	45 mm İzoleli Çelik SİRİL Boru Telli 45 mm Insulated Steel Spirals Conduit With Guide	25
APS - ICST 50	50 mm İzoleli Çelik SİRİL Boru Telli 50 mm Insulated Steel Spirals Conduit With Guide	25



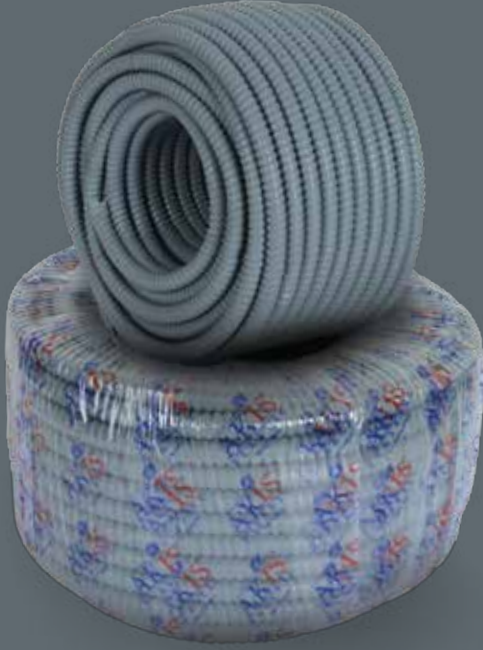

## PVC İZOLELİ ÇELİK SİRAL BORU PVC INSULATED STEEL SPIRAL CONDUIT GREY COLOR

KOD CODE	ÜRÜN ADI PRODUCT NAME	MT. PACK
APS - ICG 9	9 mm İzoleli Çelik Spiral Boru 9 mm Insulated Steel Spirals	50
APS - ICG 11	11 mm İzoleli Çelik Spiral Boru 11 mm Insulated Steel Spirals	50
APS - ICG 14	14 mm İzoleli Çelik Spiral Boru 14 mm Insulated Steel Spirals	50
APS - ICG 16	16 mm İzoleli Çelik Spiral Boru 16 mm Insulated Steel Spirals	50
APS - ICG 18	18 mm İzoleli Çelik Spiral Boru 18 mm Insulated Steel Spirals	50
APS - ICG 21	21 mm İzoleli Çelik Spiral Boru 21 mm Insulated Steel Spirals	50
APS - ICG 26	26 mm İzoleli Çelik Spiral Boru 26 mm Insulated Steel Spirals	25
APS - ICG 29	29 mm İzoleli Çelik Spiral Boru 29 mm Insulated Steel Spirals	25
APS - ICG 32	32 mm İzoleli Çelik Spiral Boru 32 mm Insulated Steel Spirals	25
APS - ICG 35	35 mm İzoleli Çelik Spiral Boru 35 mm Insulated Steel Spirals	25
APS - ICG 37	37 mm İzoleli Çelik Spiral Boru 37 mm Insulated Steel Spirals	25
APS - ICG 40	40 mm İzoleli Çelik Spiral Boru 40 mm Insulated Steel Spirals	25
APS - ICG 42	42 mm İzoleli Çelik Spiral Boru 42 mm Insulated Steel Spirals	25
APS - ICG 45	45 mm İzoleli Çelik Spiral Boru 45 mm Insulated Steel Spirals	25
APS - ICG 50	50 mm İzoleli Çelik Spiral Boru 50 mm Insulated Steel Spirals	25

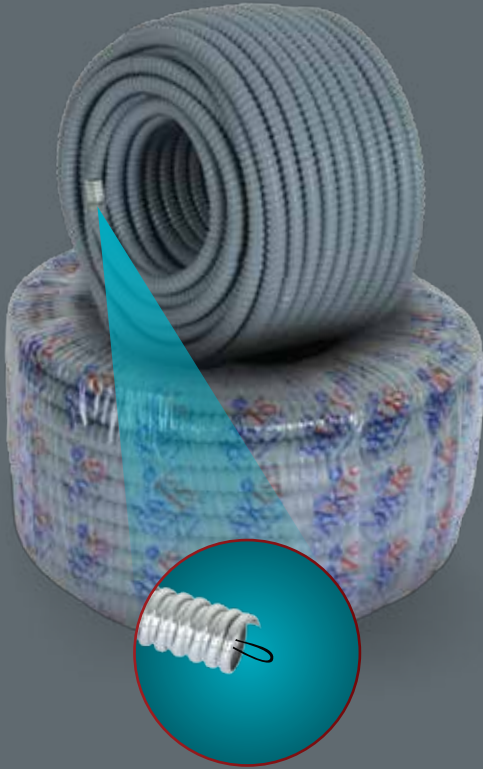

## KILAVUZ TELLİ İZOLELİ ÇELİK SİRAL BORU PVC INSULATED STEEL SPIRAL CONDUIT GREY COLOR WITH GUIDE

KOD CODE	ÜRÜN ADI PRODUCT NAME	MT. PACK
APS - ICGT 9	9 mm İzoleli Çelik Spiral Boru Telli 9 mm Insulated Steel Spirals Conduit With Guide	50
APS - ICGT 11	11 mm İzoleli Çelik Spiral Boru Telli 11 mm Insulated Steel Spirals Conduit With Guide	50
APS - ICGT 14	14 mm İzoleli Çelik Spiral Boru Telli 14 mm Insulated Steel Spirals Conduit With Guide	50
APS - ICGT 16	16 mm İzoleli Çelik Spiral Boru Telli 16 mm Insulated Steel Spirals Conduit With Guide	50
APS - ICGT 18	18 mm İzoleli Çelik Spiral Boru Telli 18 mm Insulated Steel Spirals Conduit With Guide	50
APS - ICGT 21	21 mm İzoleli Çelik Spiral Boru Telli 21 mm Insulated Steel Spirals Conduit With Guide	50
APS - ICGT 26	26 mm İzoleli Çelik Spiral Boru Telli 26 mm Insulated Steel Spirals Conduit With Guide	25
APS - ICGT 29	29 mm İzoleli Çelik Spiral Boru Telli 29 mm Insulated Steel Spirals Conduit With Guide	25
APS - ICGT 32	32 mm İzoleli Çelik Spiral Boru Telli 32 mm Insulated Steel Spirals Conduit With Guide	25
APS - ICGT 35	35 mm İzoleli Çelik Spiral Boru Telli 35 mm Insulated Steel Spirals Conduit With Guide	25
APS - ICGT 37	37 mm İzoleli Çelik Spiral Boru Telli 37 mm Insulated Steel Spirals Conduit With Guide	25
APS - ICGT 40	40 mm İzoleli Çelik Spiral Boru Telli 40 mm Insulated Steel Spirals Conduit With Guide	25
APS - ICGT 42	42 mm İzoleli Çelik Spiral Boru Telli 42 mm Insulated Steel Spirals Conduit With Guide	25
APS - ICGT 45	45 mm İzoleli Çelik Spiral Boru Telli 45 mm Insulated Steel Spirals Conduit With Guide	25
APS - ICGT 50	50 mm İzoleli Çelik Spiral Boru Telli 50 mm Insulated Steel Spirals Conduit With Guide	25



## ÇELİK SİRAL BORU STEEL SPIRAL CONDUITS

KOD CODE	ÜRÜN ADI PRODUCT NAME	MT. PACK
APS - CS 9	9 mm Çelik Spiral Boru 9 mm Steel Spirals	50
APS - CS 11	11 mm Çelik Spiral Boru 11 mm Steel Spirals	50
APS - CS 14	14 mm Çelik Spiral Boru 14 mm Steel Spirals	50
APS - CS 16	16 mm Çelik Spiral Boru 16 mm Steel Spirals	50
APS - CS 18	18 mm Çelik Spiral Boru 18 mm Steel Spirals	50
APS - CS 21	21 mm Çelik Spiral Boru 21 mm Steel Spirals	50
APS - CS 26	26 mm Çelik Spiral Boru 26 mm Steel Spirals	25
APS - CS 29	29 mm Çelik Spiral Boru 29 mm Steel Spirals	25
APS - CS 32	32 mm Çelik Spiral Boru 32 mm Steel Spirals	25
APS - CS 35	35 mm Çelik Spiral Boru 35 mm Steel Spirals	25
APS - CS 37	37 mm Çelik Spiral Boru 37 mm Steel Spirals	25
APS - CS 40	40 mm Çelik Spiral Boru 40 mm Steel Spirals	25
APS - CS 42	42 mm Çelik Spiral Boru 42 mm Steel Spirals	25
APS - CS 45	45 mm Çelik Spiral Boru 45 mm Steel Spirals	25
APS - CS 50	50 mm Çelik Spiral Boru 50 mm Steel Spirals	25



## KILAVUZ TELLİ ÇELİK SİRAL BORU STEEL SPIRAL CONDUITS WITH GUIDE

KOD CODE	ÜRÜN ADI PRODUCT NAME	MT. PACK
APS - CST 9	9 mm Çelik Spiral Boru Telli 9 mm Steel Spirals Conduit With Guide	50
APS - CST 11	11 mm Çelik Spiral Boru Telli 11 mm Steel Spirals Conduit With Guide	50
APS - CST 14	14 mm Çelik Spiral Boru Telli 14 mm Steel Spirals Conduit With Guide	50
APS - CST 16	16 mm Çelik Spiral Boru Telli 16 mm Steel Spirals Conduit With Guide	50
APS - CST 18	18 mm Çelik Spiral Boru Telli 18 mm Steel Spirals Conduit With Guide	50
APS - CST 21	21 mm Çelik Spiral Boru Telli 21 mm Steel Spirals Conduit With Guide	50
APS - CST 26	26 mm Çelik Spiral Boru Telli 26 mm Steel Spirals Conduit With Guide	25
APS - CST 29	29 mm Çelik Spiral Boru Telli 29 mm Steel Spirals Conduit With Guide	25
APS - CST 32	32 mm Çelik Spiral Boru Telli 32 mm Steel Spirals Conduit With Guide	25
APS - CST 35	35 mm Çelik Spiral Boru Telli 35 mm Steel Spirals Conduit With Guide	25
APS - CST 37	37 mm Çelik Spiral Boru Telli 37 mm Steel Spirals Conduit With Guide	25
APS - CST 40	40mm Çelik Spiral Boru Telli 40 mm Steel Spirals Conduit With Guide	25
APS - CST 42	42 mm Çelik Spiral Boru Telli 42 mm Steel Spirals Conduit With Guide	25
APS - CST 45	45 mm Çelik Spiral Boru Telli 45 mm Steel Spirals Conduit With Guide	25
APS - CST 50	50 mm Çelik Spiral Boru Telli 50 mm Steel Spirals Conduit With Guide	25

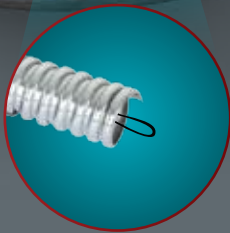

**Series Code** | **AK.04**  
**Features** | No water seal,  
Fixed type,  
Nickel plated brass

**Temperature Range** | -50°C~+200°C  
**IP Rating** | IP54  
**Mareial** | Nickel plated, brass.  
**Certificate** | CE



Product Photo

Exploded View

Item Code	NPT Size	Metric Size	PG Size	Suitable Flex. Conduit Size	Pack. /Pc
AK.04.1007	-	M12x1,5	Pg 7	10	50
AK.04.1009	1/4"	M16x1,5	Pg 9	12	50
AK.04.1011	3/8"	M16x1,5	Pg 11	16	50
AK.04.1016	1/2"	M20x1,5	Pg 16	20	50
AK.04.1021	3/4"	M25x1,5	Pg 21	25	25
AK.04.1029	1"	M32x1,5	Pg 29	32	10
AK.04.1036	1 1/4"	M40x1,5	Pg 36	40	5
AK.04.1042	1 1/2"	M50x1,5	Pg 42	50	5
AK.04.1048	2"	M63x1,5	Pg 48	63	4

**Series Code** | **AK.04**  
**Features** | No water seal,  
Swivel type,  
Nickel plated brass

**Temperature Range** | -50°C~+200°C  
**IP Rating** | IP54  
**Mareial** | Nickel plated, brass.  
**Certificate** | CE



Product Photo

Exploded View

Item Code	NPT Size	Metric Size	PG Size	Suitable Flex. Conduit Size	Pack. /Pc
AK.042007	-	M12x1,5	Pg 7	10	50
AK.04.2009	1/4"	M16x1,5	Pg 9	12	50
AK.04.2011	3/8"	M16x1,5	Pg 11	16	50
AK.04.2016	1/2"	M20x1,5	Pg 16	20	50
AK.04.2021	3/4"	M25x1,5	Pg 21	25	25
AK.04.2029	1"	M32x1,5	Pg 29	32	10
AK.04.2036	1 1/4"	M40x1,5	Pg 36	40	5
AK.04.2042	1 1/2"	M50x1,5	Pg 42	50	5
AK.04.2048	2"	M63x1,5	Pg 48	63	4

**Series Code** | **AK.05**  
**Features** | No water seal, Fixed type,  
Nickel plated brass

**Temperature Range** | -45 °C +105 °C  
**IP Rating** | IP67  
**Mareial** | Nickel plated, brass.  
**Certificate** | CE

**Product Photo** | **Profile**

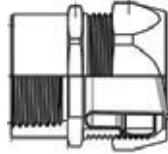

Item Code	NPT Size	Metric Size	PG Size	Suitable Flex. Conduit Size	Pack. /Pc
AK.05.1007	-	M12x1,5	Pg 7	10	50
AK.05.1009	1/4"	M16x1,5	Pg 9	12	50
AK.05.1011	3/8"	M16x1,5	Pg 11	16	50
AK.05.1016	1/2"	M20x1,5	Pg 16	20	50
AK.05.1021	3/4"	M25x1,5	Pg 21	25	25
AK.05.1029	1"	M32x1,5	Pg 29	32	10
AK.05.1036	1 1/4"	M40x1,5	Pg 36	40	5
AK.05.1042	1 1/2"	M50x1,5	Pg 42	50	5
AK.05.1048	2"	M63x1,5	Pg 48	63	4

**Series Code** | **AK.05**  
**Features** | No water seal, Swivel type,  
Nickel plated brass

**Temperature Range** | -45 °C +105 °C  
**IP Rating** | IP67  
**Mareial** | Nickel plated, brass.  
**Certificate** | CE

**Product Photo** | **Profile**

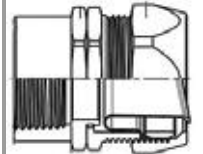

Item Code	NPT Size	Metric Size	PG Size	Suitable Flex. Conduit Size	Pack. /Pc
AK.05.2007	-	M12x1,5	Pg 7	10	50
AK.05.2009	1/4"	M16x1,5	Pg 9	12	50
AK.05.2011	3/8"	M16x1,5	Pg 11	16	50
AK.05.2016	1/2"	M20x1,5	Pg 16	20	50
AK.05.2021	3/4"	M25x1,5	Pg 21	25	25
AK.05.2029	1"	M32x1,5	Pg 29	32	10
AK.05.2036	1 1/4"	M40x1,5	Pg 36	40	5
AK.05.2042	1 1/2"	M50x1,5	Pg 42	50	5
AK.05.2048	2"	M63x1,5	Pg 48	63	4

**Male - Female Adaptor With Screw**



Item Code	Metric Size
AK-BB20MS	20x20
AK-BB25MS	25x25
AK-BB32MS	32x32
AK-BB38MS	1-1/2" x 1-1/2"
AK-BB50MS	2" x2"





## PLASTİK SİYAH SİRAL BORU BLACK PVC SPIRAL PIPE

KOD CODE	ÜRÜN ADI PRODUCT NAME	MT. PACK
<b>APS - PS 14</b>	14 mm Plastik Spiral Boru 14 mm Plastic Spirals Conduit	100
<b>APS - PS 16</b>	16 mm Plastik Spiral Boru 16 mm Plastic Spirals Conduit	100
<b>APS - PS 18</b>	18 mm Plastik Spiral Boru 18 mm Plastic Spirals Conduit	100
<b>APS - PS 20</b>	20 mm Plastik Spiral Boru 20 mm Plastic Spirals Conduit	100
<b>APS - PS 26</b>	26 mm Plastik Spiral Boru 26 mm Plastic Spirals Conduit	50
<b>APS - PS 32</b>	32 mm Plastik Spiral Boru 32 mm Plastic Spirals Conduit	25



### Ürün Renkleri - Product Colors



Turuncu  
Orange



Gri  
Grey



Mavi  
Blue

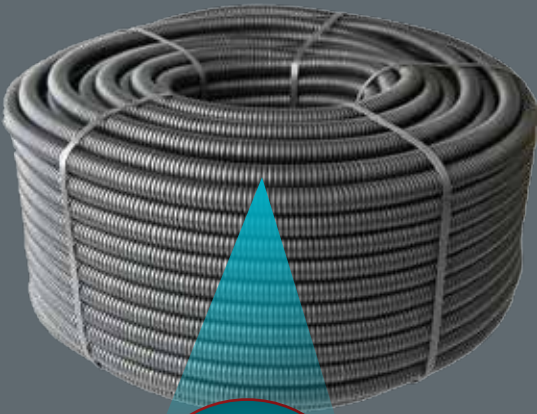

## PLASTİK SİYAH SİRAL BORU KILAVUZ TELLİ BLACK PVC SPIRAL PIPE WITH WIRE

KOD CODE	ÜRÜN ADI PRODUCT NAME	MT. PACK
<b>APS - PST 14</b>	14 mm Plastik Spiral Boru 14 mm Plastic Spirals Conduit	100
<b>APS - PST 16</b>	16 mm Plastik Spiral Boru 16 mm Plastic Spirals Conduit	100
<b>APS - PST 18</b>	18 mm Plastik Spiral Boru 18 mm Plastic Spirals Conduit	100
<b>APS - PST 20</b>	20 mm Plastik Spiral Boru 20 mm Plastic Spirals Conduit	100
<b>APS - PST 26</b>	26 mm Plastik Spiral Boru 26 mm Plastic Spirals Conduit	50
<b>APS - PST 32</b>	32 mm Plastik Spiral Boru 32 mm Plastic Spirals Conduit	25



### Ürün Renkleri - Product Colors



Turuncu  
Orange



Gri  
Grey



Mavi  
Blue



### Ürün Renkleri - Product Colors



Turuncu  
Orange



Gri  
Grey

### PP POLİPROPLEN ALEV YAYAN

## PP PLASTİK GRİ SİRİAL BORU GREY PP SPIRAL PIPE

KOD CODE	ÜRÜN ADI PRODUCT NAME	İÇ ÇAP INNER	DIŞ ÇAP OUTHER	MT. PACK
<b>APS - PSG 9</b>	Plastik SİRİAL Boru Plastic Spirals Conduit	10 mm	13	100
<b>APS - PSG 11</b>	Plastik SİRİAL Boru Plastic Spirals Conduit	12,4 mm	16	100
<b>APS - PSG 13,5</b>	Plastik SİRİAL Boru Plastic Spirals Conduit	14,4 mm	18,5	100
<b>APS - PSG 16</b>	Plastik SİRİAL Boru Plastic Spirals Conduit	17 mm	21,4	100
<b>APS - PSG 20</b>	Plastik SİRİAL Boru Plastic Spirals Conduit	20 mm	25,5	50
<b>APS - PSG 21</b>	Plastik SİRİAL Boru Plastic Spirals Conduit	23,17 mm	28,7	25
<b>APS - PSG 29</b>	Plastik SİRİAL Boru Plastic Spirals Conduit	29 mm	34,5	25



## LS TİPİ PLASTİK GRİ SİRİAL BORU LS GREY SPIRAL PIPE

KOD CODE	ÜRÜN ADI PRODUCT NAME	ÖLÇÜ SIZE	PAKET PACK
<b>APS-ICD 16</b>	16 mm Dişli SİRİAL Boru 16 mm LS Spiral Hoses	5/8	50
<b>APS-ICD 21</b>	21 mm Dişli SİRİAL Boru 21 mm LS Spiral Hoses	3/4	50
<b>APS-ICD 25</b>	25 mm Dişli SİRİAL Boru 25 mm LS Spiral Hoses	1"	25
<b>APS-ICD 29</b>	29 mm Dişli SİRİAL Boru 29 mm LS Spiral Hoses	1 1/7	25
<b>APS-ICD 32</b>	32 mm Dişli SİRİAL Boru 32 mm LS Spiral Hoses	1 1/4	25
<b>APS-ICD 38</b>	38 mm Dişli SİRİAL Boru 38 mm LS Spiral Hoses	1 1/2	25
<b>APS-ICD 50</b>	50 mm Dişli SİRİAL Boru 50 mm LS Spiral Hoses	2/P	25







## 6 ATÜ - 6 ATU

### POLİETİLEN KANGAL BORULAR (SİYAH) POLYETHYLENE COIL PIPES (BLACK)

KOD CODE	ÜRÜN ADI PRODUCT NAME	NEWTON	MT. PACK
<b>APS - KB 14</b>	<b>14 mm Polietilen Boru 6 ATÜ</b> 14 mm Polythene Pipe 6 ATU	450	100
<b>APS - KB 16</b>	<b>16 mm Polietilen Boru 6 ATÜ</b> 16 mm Polythene Pipe 6 ATU	450	100
<b>APS - KB 18</b>	<b>18 mm Polietilen Boru 6 ATÜ</b> 18 mm Polythene Pipe 6 ATU	450	100
<b>APS - KB 20</b>	<b>20 mm Polietilen Boru 6 ATÜ</b> 20 mm Polythene Pipe 6 ATU	450	100
<b>APS - KB 25</b>	<b>25 mm Polietilen Boru 6 ATÜ</b> 26 mm Polythene Pipe 6 ATU	450	100
<b>APS - KB 32</b>	<b>32 mm Polietilen Boru 6 ATÜ</b> 32 mm Polythene Pipe 6 ATU	450	50



## 10 ATÜ - 10 ATU

### POLİETİLEN KANGAL BORULAR (SİYAH) POLYETHYLENE COIL PIPES (BLACK)

KOD CODE	ÜRÜN ADI PRODUCT NAME	NEWTON	MT. PACK
<b>APS - KBD 14</b>	<b>14 mm Polietilen Boru 10 ATÜ</b> 14 mm Polythene Pipe 10 ATU	750	100
<b>APS - KBD 16</b>	<b>16 mm Polietilen Boru 10 ATÜ</b> 16 mm Polythene Pipe 10 ATU	750	100
<b>APS - KBD 18</b>	<b>18 mm Polietilen Boru 10 ATÜ</b> 18 mm Polythene Pipe 10 ATU	750	100
<b>APS - KBD 20</b>	<b>20 mm Polietilen Boru 10 ATÜ</b> 20 mm Polythene Pipe 10 ATU	750	100
<b>APS - KBD 25</b>	<b>25 mm Polietilen Boru 10 ATÜ</b> 26 mm Polythene Pipe 10 ATU	750	100
<b>APS - KBD 32</b>	<b>32 mm Polietilen Boru 10 ATÜ</b> 32 mm Polythene Pipe 10 ATU	750	50



## HALOGEN FREE KANGAL BORULAR (TURUNCU) HALOGEN FREE COIL PIPES (ORANGE)

KOD CODE	ÜRÜN ADI PRODUCT NAME	NEWTON	MT. PACK
<b>APS - HB 14</b>	14 mm Polietilen Boru 6 ATÜ 14 mm Polythene Pipe 6 ATU	450	100
<b>APS - HB 16</b>	16 mm Polietilen Boru 6 ATÜ 16 mm Polythene Pipe 6 ATU	450	100
<b>APS - HB 18</b>	18 mm Polietilen Boru 6 ATÜ 18 mm Polythene Pipe 6 ATU	450	100
<b>APS - HB 20</b>	20 mm Polietilen Boru 6 ATÜ 20 mm Polythene Pipe 6 ATU	450	100
<b>APS - HB 25</b>	25 mm Polietilen Boru 6 ATÜ 26 mm Polythene Pipe 6 ATU	450	100
<b>APS - HB 32</b>	32 mm Polietilen Boru 6 ATÜ 32 mm Polythene Pipe 6 ATU	450	50



**6 ATÜ - 6 ATU**  
**ALEV YAYAN**

## HALOGEN FREE KANGAL BORULAR (TURUNCU) HALOGEN FREE COIL PIPES (ORANGE)

KOD CODE	ÜRÜN ADI PRODUCT NAME	NEWTON	MT. PACK
<b>APS - HBD 14</b>	14 mm Polietilen Boru 10 ATÜ 14 mm Polythene Pipe 10 ATU	750	100
<b>APS - HBD 16</b>	16 mm Polietilen Boru 10 ATÜ 16 mm Polythene Pipe 10 ATU	750	100
<b>APS - HBD 18</b>	18 mm Polietilen Boru 10 ATÜ 18 mm Polythene Pipe 10 ATU	750	100
<b>APS - HBD 20</b>	20 mm Polietilen Boru 10 ATÜ 20 mm Polythene Pipe 10 ATU	750	100
<b>APS - HBD 25</b>	25 mm Polietilen Boru 10 ATÜ 26 mm Polythene Pipe 10 ATU	750	100
<b>APS - HBD 32</b>	32 mm Polietilen Boru 10 ATÜ 32 mm Polythene Pipe 10 ATU	750	50



**10 ATÜ - 10 ATU**  
**ALEV YAYAN**



**YENİ ÜRÜN**  
NEW PRODUCT

**KOD - CODE**

unshielded twisted pairs / ekranlız bükülü çiftler

IEEE 802.3 standartlarına göre 5e kategorisi  
category 5e according to IEEE 802.3 standards

**CAT-5e UTP**

**YAPISI - CONSTRUCTION**

- ① **Elektrolitik Bakır İletken - Electrolytic Copper Wire**      ② **PE İzolasyon / PE Insulation**      ③ **FR - PVC Dış Kılıf / Fr - PVC Outer Sheath**

**KULLANIM YERLERİ - APPLICATION**

Bu kablolar veri iletişimde, 10 BaseT (IEEE 802.3) ETHERNET ,100 BaseT (IEEE 802.3u) FAST ETHERNET , 100 Vg-AnyLAN (IEEE 802.12) , 4/16 Mbps Token Ring (IEEE 802.5) , 100 Mbps CDDI , 52/155 Mbps ATM , 1000 Base T (Gigabit Ethernet)(IEEE 802.3 ab) kabloları olarak kullanılırlar.

These types of cables are used for 10 BaseT (IEEE 802.3) ETHERNET ,100 BaseT (IEEE 802.3u) FAST ETHERNET , 100 Vg-AnyLAN (IEEE 802.12) , 4/16 Mbps Token Ring (IEEE 802.5) , 100 Mbps CDDI , 52/155 Mbps ATM , 1000 Base T ( Gigabit Ethernet) (IEEE 802.3 ab).

**TEKNİK BİLGİLER - TECHNICAL DATA**

<b>İletken Direnci</b> Conductor Resistance	94 Ω/km	<b>Efektif Taşıma Kapasitesi</b> Mutual Capacitance	52 pf/m	<b>Direnç Dengesizliği</b> Resistance Unbalanced	%3
<b>Yalıtım Direnci</b> Insulation Resistance	5000 MΩ .km	<b>Bükülme Min. Yarıçapı</b> Bending Min. Diameter	8XD mm	<b>Karakteristik Empedans</b> Characteristic Impedance	100±15 Ω
<b>Test Voltajı</b> Test Voltage	1200 V	<b>Çalışma Sıcaklığı</b> Working Temperature	-20°C... +60°C	<b>Yayımla Hızı</b> Velocity of Propagation	%67
<b>Çalışma Voltajı</b> Working Voltage	250 V	<b>Alev Testi Standardı</b> Flame Test Standard	IEC 60332-1-2, VDE 0482-332-1-2, EN 60332-1-2	<b>Dış Kılıf Renk No</b> Outer Sheath Colour No	RAL 7032

**NOTLAR - NOTES**

Bu kablolar 250 Mbit/sn hıza kadar analog ve dijital sinyallerin iletimine uygun kullanıma sahiptirler.

These cables are suitable for analog and digital signal transmission up to 250 Mbit/sec.

**DAMAR TANITIM RENKLERİ - CORE IDENTIFICATION COLOURS**

RENK NO COLOUR NUMBER	A TELİ A WIRE	B TELİ B WIRE
1	Mavi / Blue	Beyaz-Mavi / White-Blue
2	Turuncu / Orange	Beyaz-Turuncu / White-Orange
3	Yeşil / Green	Beyaz-Yeşil / White-Green
4	Kahve / Brown	Beyaz-Kahverengi / White-Brown

**GÖRSEL TANITIM - VISUAL INTRODUCTION**



IEC-EN-VDE 60332-1-2  
alev testi standardı  
flame test standard



reach uyumluluğu  
reach compliance



rohs uyumluluğu  
rohs compliance



avrupa konformasyonu  
european conformity

**Unitech**

**ELEKTRİKSEL ÖZELLİKLER - ELECTRICAL SPECIFICATIONS**

FREKANS FREQUENCY	ZAYIFLAMA ATTENUATION	YAKIN UÇ DİAFONİSİ NEAR END CROSSTALK	GERİ DÖNÜŞ KAYBI
1	2,1	65,3	20
4	4,1	56,3	23
10	6,5	50,3	25
16	8,3	47,2	25
20	9,3	45,8	25

**ELEKTRİKSEL ÖZELLİKLER - ELECTRICAL SPECIFICATIONS**

FREKANS FREQUENCY	ZAYIFLAMA ATTENUATION	YAKIN UÇ DİAFONİSİ NEAR END CROSSTALK	GERİ DÖNÜŞ KAYBI
31,2	11,7	42,9	24
62,5	17	39,4	22
100	22	85,3	20
125	24,9	33,8	19



**YENİ ÜRÜN**  
NEW PRODUCT

### KOD - CODE

unshielded twisted pairs / ekranlısüz bükülü çiftler

IEEE 802.3 standartlarına göre 6. kategori  
category 6 according to IEEE 802.3 standards

**CAT-6 UTP**

### YAPISI - CONSTRUCTION

- ① Elektrolitik Bakır İletken - Electrolytic Copper Wire      ② PE İzolasyon / PE Insulation      ③ PVC Dış Kılıf / PVC Outer Sheath

### KULLANIM YERLERİ - APPLICATION

Bu kablolar veri iletişimde, 10 BaseT (IEEE 802.3) ETHERNET ,100 BaseT (IEEE 802.3u) FAST ETHERNET, 100 Vg-AnyLAN (IEEE 802.12) , 4/16 Mbps Token Ring (IEEE 802.5) , 100 Mbps CDDI , 250 Mbps ATM, 1000 Base T (Gigabit Ethernet)(IEEE 802.3 ab) kabloları olarak kullanılırlar.

These types of cables are used for 10 BaseT (IEEE 802.3) ETHERNET ,100 BaseT (IEEE 802.3u) FAST ETHERNET, 100 Vg-AnyLAN (IEEE 802.12) , 4/16 Mbps Token Ring (IEEE 802.5) , 100 Mbps CDDI , 250 Mbps ATM , 1000 Base T ( Gigabit Ethernet) (IEEE 802.3 ab).

### TEKNİK BİLGİLER - TECHNICAL DATA

<b>İletken Direnci</b> Conductor Resistance	23 AWG = 78 Ω/km 24 AWG = 94 Ω/km	<b>Efektif Taşıma Kapasitesi</b> Mutual Capacitance	48 pf/m	<b>Direnç Dengesizliği</b> Resistance Unbalanced	%3
<b>Yalıtım Direnci</b> Insulation Resistance	5000 MΩ .km	<b>Bükülme Min. Yarıçapı</b> Bending Min. Diameter	8XD mm	<b>Karakteristik Empedans</b> Characteristic Impedance	100±15 Ω
<b>Test Voltajı</b> Test Voltage	1200 V	<b>Çalışma Sıcaklığı</b> Working Temperature	-20°C... +60°C	<b>Yayımla Hızı</b> Velocity of Propagation	%67
<b>Çalışma Voltajı</b> Working Voltage	250 V	<b>Alev Testi Standardı</b> Flame Test Standard	IEC 60332-1-2, VDE 0482-332-1-2, EN 60332-1-2	<b>Dış Kılıf Renk No</b> Outer Sheath Colour No	RAL 7032

### NOTLAR - NOTES

Bu kablolar 250 Mbit/sn hıza kadar analog ve dijital sinyallerin iletimine uygun kullanıma sahiptirler.

These cables are suitable for analog and digital signal transmission up to 250 Mbit/sec.

### DAMAR TANITIM RENKLERİ - CORE IDENTIFICATION COLOURS

RENK NO COLOUR NUMBER	A TELİ A WIRE	B TELİ B WIRE
1	Mavi / Blue	Beyaz-Mavi / White-Blue
2	Turuncu / Orange	Beyaz-Turuncu / White-Orange
3	Yeşil / Green	Beyaz-Yeşil / White-Green
4	Kahve / Brown	Beyaz-Kahverengi / White-Brown

### GÖRSEL TANITIM - VISUAL INTRODUCTION



IEC-EN-VDE 60332-1-2  
alev testi standardı  
flame test standard



reach uyumluluğu  
reach compliance



rohs uyumluluğu  
rohs compliance



avrupa konformasyonu  
european conformity

**Unitech**

### ELEKTRİKSEL ÖZELLİKLER - ELECTRICAL SPECIFICATIONS

FREKANS FREQUENCY	ZAYIFLAMA ATTENUATION	YAKIN UÇ DİAFONİSİ NEAR END CROSSTALK	GERİ DÖNÜŞ KAYBI
1	2,1	74	20
10	6	59	25
16	7,6	56	25
20	8,5	55	25
62,5	15,5	47	21,5

### ELEKTRİKSEL ÖZELLİKLER - ELECTRICAL SPECIFICATIONS

FREKANS FREQUENCY	ZAYIFLAMA ATTENUATION	YAKIN UÇ DİAFONİSİ NEAR END CROSSTALK	GERİ DÖNÜŞ KAYBI
100	19,9	44	20,1
125	22,5	43	19,5
155,5	25,4	42	18,8
200	29,2	40	18
250	33	38	17,3

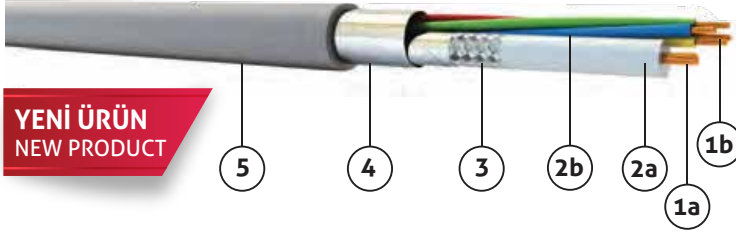

YENİ ÜRÜN  
NEW PRODUCT

KOD - CODE

closed-circuit television / kapalı devre görüntüleme

CCTV

### YAPISI - CONSTRUCTION

- 1 Koaksiyel - Coaxial : **7x0,20 mm<sup>2</sup> Bükülü Elektrolitik Tavlı Bakır İletken / Electrolytic Stranded Copper Conductor**  
**Sinyal Damarları - Signal Cores : 0,22 mm<sup>2</sup> Bükülü Elektrolitik Tavlı Bakır İletken / Electrolytic Stranded Copper Conductor**  
**Kontrol Damarları - Control Cores : 0,50 mm<sup>2</sup> Bükülü Elektrolitik Tavlı Bakır İletken / Electrolytic Stranded Copper Conductor**
- 2 Koaksiyel - Coaxial : **2,5 mm<sup>2</sup> Solid PE İzolasyon / Solid Insulation**  
**Sinyal Damarları - Signal Cores : Solid PE İzolasyon / Solid Insulation**  
**Kontrol Damarları - Control Cores : PVC İzolasyon / PVC Insulation**
- 3 Elektrolitik Alüminyum Örgü / Electrolytic Aluminum Braiding
- 4 Al-Pes Bant + Alüminyum Örgü / Al-Pes Tape + Aliminum Braid
- 5 PVC Dış Kılıf / PVC Outer Sheath

### KULLANIM YERLERİ - APPLICATION

Bu kablolar kapalı devre tv ve kamera sistemlerinde kısa mesafeli video, ses ve sinyal iletiminde kullanılırlar.  
 Bu tür kompozit kablolar kullanım amaçlarına göre farklı kesitlerde üretilebilmektedir.

These types of cables are used in closed-circuit tv and camera systems, video,sound and signal transmission in short ranges.  
 These type of composite cables can be produced in different sections regarding to their respective application

### TEKNİK BİLGİLER - TECHNICAL DATA

İletken Direnci Conductor Resistance	0,22 mm <sup>2</sup> = 79 Ω/km 0,5 mm <sup>2</sup> = 39 Ω/km	Efektif Taşıma Kapasitesi Mutual Capacitance	67 pf/m	Empedans Empendance	75±3 Ω
Test Voltajı Test Voltage	1200 V	Bükülme Min. Yarıçapı Bending Min. Diameter	10XD mm	Dış Kılıf Renk No Outer Sheath Colour No	RAL 7032
Çalışma Voltajı Working Voltage	250 V	Çalışma Sıcaklığı Working Temperature	-30°C... +70°C	Alev Testi Standardı Flame Test Standard	IEC 60332-1-2, VDE 0482-332-1-2, EN 60332-1-2

### GÖRSEL TANITIM - VISUAL INTRODUCTION



-30/+70 °C  
çalışma sıcaklığı  
working temperature



IEC-EN-VDE 60332-1-2  
alev testi standardı  
flame test standard



reach uyumluluğu  
reach compliance



rohs uyumluluğu  
rohs compliance



avrupa konformasyonu  
european conformity

### BOYUT VE AĞIRLIKLAR - DIMENSIONS AND WEIGHTS

NOMINAL KESİT NOMINAL CROSS SECTION mm <sup>2</sup>	DIŞ ÇAP OVERALL DIAMETER mm	BAKIR AĞIRLIĞI COPPER WEIGHT kg/km	KABLO AĞIRLIĞI CABLE WEIGHT kg/km	STANDART SEVK UZUNLUĞU STANDARD DELIVERY LENGTH m
Mini Coax + (2x0,50 + 1x0,22) mm <sup>2</sup>	6,00	24	55	100/500/1000
Mini Coax + (2x0,50 + 2x0,22) mm <sup>2</sup>	6,00	26	57	100/500/1000
Mini Coax + (2x0,50 + 3x0,22) mm <sup>2</sup>	6,00	28	58	100/500/1000
Mini Coax + (2x0,50 + 4x0,22) mm <sup>2</sup>	6,00	30	60	100/500/1000
Mini Coax + (2x0,50 + 6x0,22) mm <sup>2</sup>	6,50	34	63	100/500/1000
Mini Coax + 12x0,22 mm <sup>2</sup>	8,00	36	85	100/500/1000



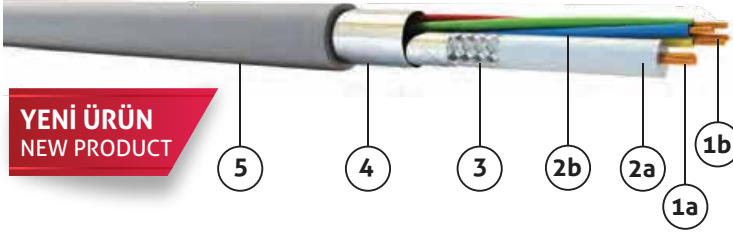

**YENİ ÜRÜN**  
NEW PRODUCT

### KOD - CODE

aluminum braided / alüminyum örgülü

closed-circuit television / kapalı devre görüntüleme

CCTV-AL

### YAPISI - CONSTRUCTION

- 1 Koaksiyel - Coaxial : **7x0,20 mm<sup>2</sup> Bükülü Elektrolitik Tavlı Bakır İletken / Electrolytic Stranded Copper Conductor**  
**Sinyal Damarları - Signal Cores : 0,22 mm<sup>2</sup> Bükülü Elektrolitik Tavlı Bakır İletken / Electrolytic Stranded Copper Conductor**  
**Kontrol Damarları - Control Cores : 0,50 mm<sup>2</sup> Bükülü Elektrolitik Tavlı Bakır İletken / Electrolytic Stranded Copper Conductor**
- 2 Koaksiyel - Coaxial : **2,5 mm<sup>2</sup> Solid PE İzolasyon / Solid Insulation**  
**Sinyal Damarları - Signal Cores : Solid PE İzolasyon / Solid Insulation**  
**Kontrol Damarları - Control Cores : PVC İzolasyon / PVC Insulation**
- 3 Elektrolitik Alüminyum Örgü / Electrolytic Aluminum Braiding
- 4 Al-Pes Bant + Alüminyum Örgü / Al-Pes Tape + Aluminum Braid
- 5 PVC Dış Kılıf / PVC Outer Sheath

### KULLANIM YERLERİ - APPLICATION

Bu kablolar kapalı devre tv ve kamera sistemlerinde kısa mesafeli video, ses ve sinyal iletiminde kullanılırlar.  
 Bu tür kompozit kablolar kullanım amaçlarına göre farklı kesitlerde üretilebilmektedir.

These types of cables are used in closed-circuit tv and camera systems, video, sound and signal transmission in short ranges.  
 These type of composite cables can be produced in different sections regarding to their respective application

### TEKNİK BİLGİLER - TECHNICAL DATA

<b>İletken Direnci</b> Conductor Resistance	0,22 mm <sup>2</sup> = 79 Ω/km 0,5 mm <sup>2</sup> = 39 Ω/km	<b>Efektif Taşıma Kapasitesi</b> Mutual Capacitance	67 pf/m	<b>Empedans</b> Empedance	75±3 Ω
<b>Test Voltajı</b> Test Voltage	1200 V	<b>Bükülme Min. Yarıçapı</b> Bending Min. Diameter	10XD mm	<b>Dış Kılıf Renk No</b> Outer Sheath Colour No	RAL 7032
<b>Çalışma Voltajı</b> Working Voltage	250 V	<b>Çalışma Sıcaklığı</b> Working Temperature	-30°C... +70°C	<b>Alev Testi Standardı</b> Flame Test Standard	IEC 60332-1-2, VDE 0482-332-1-2, EN 60332-1-2

### GÖRSEL TANITIM - VISUAL INTRODUCTION



-30/+70 °C  
çalışma sıcaklığı  
working temperature



IEC-EN-VDE 60332-1-2  
alev testi standardı  
flame test standard



reach uyumluluğu  
reach compliance



rohs uyumluluğu  
rohs compliance



avrupa konformasyonu  
european conformity

### BOYUT VE AĞIRLIKLAR - DIMENSIONS AND WEIGHTS

NOMINAL KESİT NOMINAL CROSS SECTION mm <sup>2</sup>	DIŞ ÇAP OVERALL DIAMETER mm	BAKIR AĞIRLIĞI COPPER WEIGHT kg/km	KABLO AĞIRLIĞI CABLE WEIGHT kg/km	STANDART SEVK UZUNLUĞU STANDARD DELIVERY LENGTH m
Mini Coax + (2x0,50 + 1x0,22) mm <sup>2</sup>	6,00	24	55	100/500/1000
Mini Coax + (2x0,50 + 2x0,22) mm <sup>2</sup>	6,00	26	57	100/500/1000
Mini Coax + (2x0,50 + 3x0,22) mm <sup>2</sup>	6,00	28	58	100/500/1000
Mini Coax + (2x0,50 + 4x0,22) mm <sup>2</sup>	6,00	30	60	100/500/1000
Mini Coax + (2x0,50 + 6x0,22) mm <sup>2</sup>	6,50	34	63	100/500/1000
Mini Coax + 12x0,22 mm <sup>2</sup>	8,00	36	85	100/500/1000

**EKONOMİK SERİ PLASTİK SIRA KLEMENSLER - ECONOMIC SERIE PLASTIC WIRE CONNECTORS**



KOD - CODE	ÜRÜN ADI - PRODUCT NAME	SIRA - SEQUENCE	PAKET - PACKAGE
<b>AS 100</b>	No. 1 (2.5 - 4 mm <sup>2</sup> )	12'li	50
<b>AS 200</b>	No. 2 (4 - 6 mm <sup>2</sup> )	12'li	50
<b>AS 300</b>	No. 3 (6 - 10 mm <sup>2</sup> )	10'lu	50
<b>AS 400</b>	No. 4 (10 - 16 mm <sup>2</sup> )	6'lı	50
<b>AS 500</b>	No. 5 (16 - 25 mm <sup>2</sup> )	6'lı	50

**150 C° ISIYA DAYANIKLI PLASTİK SIRA KLEMENSLER - FIRE - PROOF PLASTIC WIRE CONNECTORS**

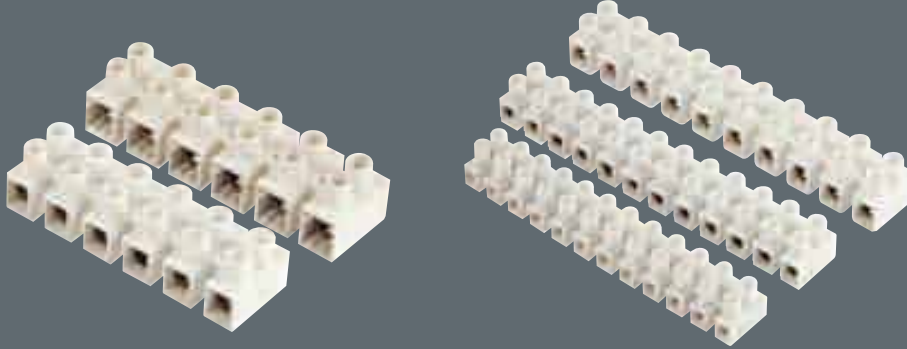

KOD - CODE	ÜRÜN ADI - PRODUCT NAME	SIRA - SEQUENCE	PAKET - PACKAGE
<b>AS 501</b>	No. 1 (2.5 - 4 mm <sup>2</sup> ) ısıya dayanıklı	12'li	50
<b>AS 502</b>	No. 2 (4 - 6 mm <sup>2</sup> ) ısıya dayanıklı	12'li	50
<b>AS 503</b>	No. 3 (6 - 10 mm <sup>2</sup> ) ısıya dayanıklı	10'lu	50
<b>AS 504</b>	No. 4 (10 - 16 mm <sup>2</sup> ) ısıya dayanıklı	6'lı	50
<b>AS 505</b>	No. 5 (16 - 25 mm <sup>2</sup> ) ısıya dayanıklı	6'lı	50

**ŞEFFAF PLASTİK SIRA KLEMENSLER - TRANSPARENT PLASTIC WIRE CONNECTORS**

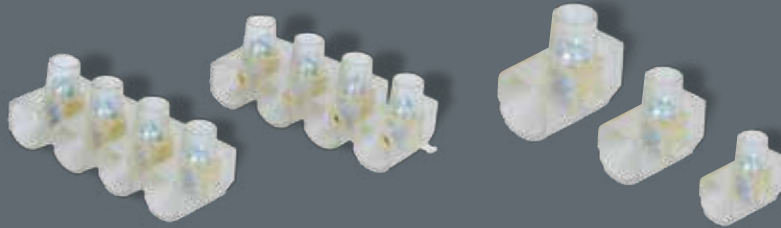

KOD - CODE	ÜRÜN ADI - PRODUCT NAME	PAKET - PACKAGE
<b>APL 102</b>	No. 2 (4 - 6 mm <sup>2</sup> ) 12'li Şeffaf Isıya Dayanıklı - 12'li Transparent Fire Proof	50
<b>APL 103</b>	No. 3 (6 - 10 mm <sup>2</sup> ) 10'lu Şeffaf Isıya Dayanıklı - 10'lu Transparent Fire Proof	50
<b>APL 104</b>	No. 4 (10 - 16 mm <sup>2</sup> ) 6'lı Şeffaf Isıya Dayanıklı - 6'lı Transparent Fire Proof	50
<b>APL 105</b>	No. 5 (16 - 25 mm <sup>2</sup> ) 6'lı Şeffaf Isıya Dayanıklı - 6'lı Transparent Fire Proof	50

**BUAT KLEMENSLERİ (1.0 - 2.5 mm<sup>2</sup>) Halogen Free - Alev İletmez**

KOD - CODE	ÜRÜN ADI - PRODUCT NAME	PAKET - PACKAGE
<b>WAGO.2273-202</b>	2 Kutuplu Buat İç Klemens	100
<b>WAGO.2273-203</b>	3 Kutuplu Buat İç Klemens	100
<b>WAGO.2273-204</b>	4 Kutuplu Buat İç Klemens	100
<b>WAGO.2273-205</b>	5 Kutuplu Buat İç Klemens	100
<b>WAGO.773-106</b>	6 Kutuplu Buat İç Klemens	50
<b>WAGO.2273-208</b>	8 Kutuplu Buat İç Klemens	50

**BUAT KLEMENSLERİ (1.0 - 2.5 mm<sup>2</sup>) Halogen Free - Alev İletmez**

KOD - CODE	ÜRÜN ADI - PRODUCT NAME	PAKET - PACKAGE
<b>WAGO.221-412</b>	2 x 4 mm Çok Amaçlı Klemens	100
<b>WAGO.221-413</b>	3 x 4 mm Çok Amaçlı Klemens	50
<b>WAGO.221-415</b>	5 x 4 mm Çok Amaçlı Klemens	25
<b>WAGO.221-500</b>	Ray Montaj Adaptörü	50

**BUAT KLEMENSLERİ (1.0 - 2.5 mm<sup>2</sup>) Halogen Free - Alev İletmez**

KOD - CODE	ÜRÜN ADI - PRODUCT NAME	PAKET - PACKAGE
<b>WAGO.224-101</b>	2.5 mm Tek Girişli Konnektör	100
<b>WAGO.224-112</b>	2.5 mm Çift Girişli Konnektör	100
<b>WAGO.224-201</b>	2.5 m İki Taraflı Yaylı Konnektör	50

## SİYAH KASA BUATLAR KASING JUNCTION BOX BLACK



KOD CODE	ÜRÜN ADI PRODUCT NAME	ÇUVAL SACK	KOLİ BOX
AK - 568	Norm Buat Kapaklı With cover	500	50
AK - 565	Geçmeli Derin Kasa Kapaksız Deep Case Junction Box With Out Cover	500	50
AK - 564	Ayçıpan Kasa 1'li Dry Wall Case 1	500	50
AK - 560	Norm Kasa Normal Junction Box	500	50

## TURUNCU KASA BUATLAR HALOGEN FREE KASING JUNCTION BOX ORANGE HALOGEN FREE



KOD CODE	ÜRÜN ADI PRODUCT NAME	ÇUVAL SACK	KOLİ BOX
AK.0629	Geçmeli Derin Kasa KAPAKSIZ	500	50
AK.0637	Norm Kasa	500	50
AK.0638	Norm Buat	500	50
AK.0630	Alçıpan Kasa	500	50
AK.0640	Alçıpan Kasa GEÇMELİ	500	50
AK.0652	Alçıpan Kasa 2'li	500	50
AK.0653	Alçıpan Kasa 3'lü	500	50
AK.0654	Alçıpan Kasa 4'lü	500	50
AK.0655	Alçıpan Kasa 5'li	500	50
AK.0656	Alçıpan Kasa 6'lı	500	50
AK.0632	Alçıpan Buat	500	50
AK.0642	Plastik Takoz 14-18	500	50



### 80 X 80 X 45 TERMOPLASTİK BUAT

### 80 X 80 X 45 THERMOPLASTIC JUNCTION BOX

KOD CODE	ÜRÜN ADI PRODUCT NAME	KOLİ BOX
APL - 106	80 x 80 x 45 Termoplastik Buat	10

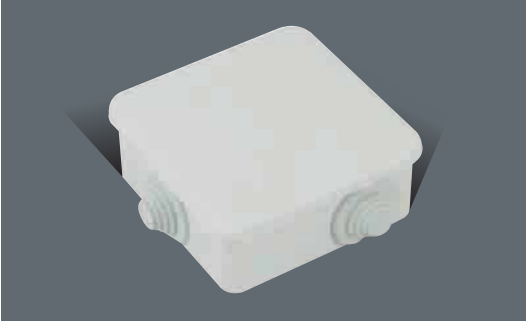

### 85 X 85 KARE ANTİGRÖN BUAT

### 85 X 85 ANTİGRÖN JUNCTION BOX

KOD CODE	ÜRÜN ADI PRODUCT NAME	KOLİ BOX
APL - 107	85 x 85 Kare Antigrön Buat	10



### SİVA ALTI KARE BUAT (SİYAH)

### FLUSH MOUNTED SQUARE JUNCTION BOX (BLACK)

KOD CODE	ÜRÜN ADI PRODUCT NAME	KOLİ BOX
AKA 350	100 x 100 Kare Buat - Square Junction	10
AKA 351	120 x 120 Kare Buat - Square Junction	10
AKA 352	150 x 150 Kare Buat - Square Junction	10
AKA 353	200 x 200 Kare Buat - Square Junction	10

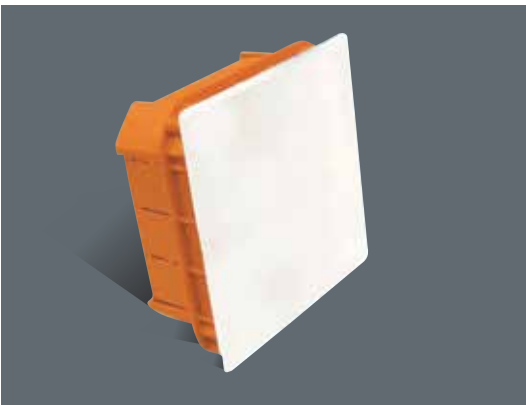

### SİVA ALTI KARE BUAT (TURUNCU)

### FLUSH MOUNTED SQUARE JUNCTION BOX (ORANGE)

KOD CODE	ÜRÜN ADI PRODUCT NAME	KOLİ BOX
AKA 360	100 x 100 Kare Buat - Square Junction	10
AKA 361	120 x 120 Kare Buat - Square Junction	10
AKA 362	150 x 150 Kare Buat - Square Junction	10
AKA 363	200 x 200 Kare Buat - Square Junction	10

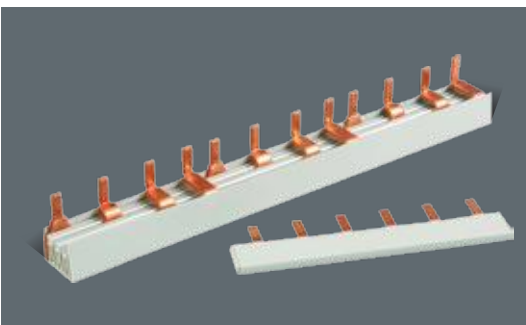

### BARALAR

### BARA

KOD CODE	ÜRÜN ADI PRODUCT NAME	KOLİ BOX
AP 1001	Trifaze Otomat Baras 1mm 53cm (10 grup) 80A	25
AP 1002	Monofaze Otomat Baras 1mm 106cm (56 otomat) 80A	50



## BETON ÇİVİ KROŞE - CONCRETE NAIL CROCHET

**YENİ ÜRÜN**  
NEW PRODUCT



KOD - CODE	ÜRÜN ADI - PRODUCT NAME	KOLİ - BOX
AK-0000	0 NO. ÇİVİLİ KROŞE	20.000
AK-0001	1 NO. ÇİVİLİ KROŞE	20.000
AK-0002	2 NO. ÇİVİLİ KROŞE	20.000
AK-0003	3 NO. ÇİVİLİ KROŞE	20.000
AK-0004	4 NO. ÇİVİLİ KROŞE	20.000
AK-0005	5 NO. ÇİVİLİ KROŞE	10.000
AK-0006	6 NO. ÇİVİLİ KROŞE	10.000
AK-0007	7 NO. ÇİVİLİ KROŞE	10.000

## ETANJ TİPİ KABLO RAKORLARI (SOMUNLU) - ETANJ TYPE CABLE FITTINGS (NUT) IP68

**YENİ ÜRÜN**  
NEW PRODUCT



KOD - CODE	ÜRÜN ADI - PRODUCT NAME	KUTU - BOX
AK.2918	PG 7 Kablo Rakoru	400
AK.2919	PG 9 Kablo Rakoru	300
AK.2920	PG 11 Kablo Rakoru	200
AK.2921	PG 13,5 Kablo Rakoru	150
AK.2922	PG 16 Kablo Rakoru	125
AK.2923	PG 21 Kablo Rakoru	75
AK.2924	PG 29 Kablo Rakoru	30
AK.2925	PG 36 Kablo Rakoru	20
AK.2926	PG 42 Kablo Rakoru	15
AK.2927	PG 48 Kablo Rakoru	8

Polyamid  
Halogen Free, Alev Yanmaz

## KABLO BAĞLARI - CABLE TIES

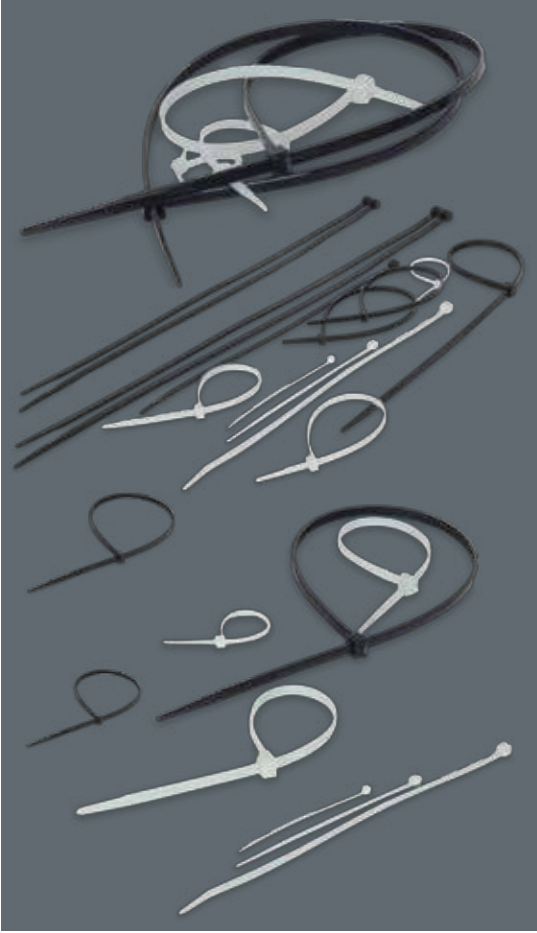

KOD CODE	EN WIDTH	BOY SIZE	POŞET MİKTARI BAG PCS.	KOLİ MİKTARI BOX PCS.	MAKSİMUM SIKMA ÇAPI (MM) MAX. CLAMPING DIAMETER (MM)	AÇILMA MUKAVEMETİ (KG) TENSILE STRENGTH (KG)
AK 12510	2,5	100	250	40.000	26	8
AK 12515	2,5	150	100	20.000	35	8
AK 12520	2,5	200	100	15.000	50	8
AK 13615	3,6	150	100	10.000	35	18
AK 13620	3,6	200	100	10.000	50	18
AK 13625	3,6	250	100	10.000	65	18
AK 13630	3,6	300	100	10.000	80	18
AK 13637	3,6	370	100	10.000	100	18
AK 14820	4,8	200	100	10.000	50	25
AK 14825	4,8	250	100	10.000	65	25
AK 14830	4,8	300	100	10.000	80	25
AK 14838	4,8	380	100	5.000	100	25
AK 14840	4,8	400	100	5.000	102	25
AK 17630	7,6	300	100	3.000	85	55
AK 17638	7,6	380	100	2.500	102	55
AK 17645	7,6	450	100	3.000	135	55
AK 17655	7,6	550	100	2.500	165	55
AK 19078	9,0	780	100	1.000	235	80
AK 19095	9,0	950	100	1.000	280	80

## YAPIŞKANLI KROŞE - ADHESIVE STRAPS

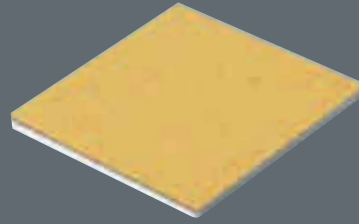
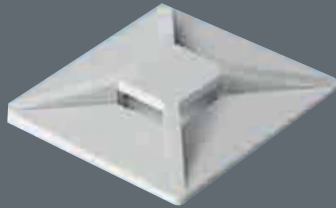

KOD - CODE	ÜRÜN ADI - PRODUCT NAME	PAKET - PACKAGE	KOLİ - BOX
AK 919	19 x 19 Yapışkan Kroşe	100	10.000
AK 828	28 x 28 Yapışkan Kroşe	100	4.000

## HELEZON PANO SİRALLERİ - HELEZON PANEL SPIRAL



KOD CODE	ÜRÜN ADI PRODUCT NAME	PAKET PACKAGE	KOLİ BOX
AKPS - 1	No. 1 (6mm)	100	4.000
AKPS - 2	No. 2 (8mm)	100	2.000
AKPS - 3	No. 3 (11mm)	100	1.500
AKPS - 4	No. 4 (14mm)	50	800
AKPS - 5	No. 5 (17mm)	50	800

**KHLSM**  
**Electricity**  
**Meters**  
**Offers**  
**Quality,**  
**Confidence**  
**and**  
**Economy**  
**to its**  
**Customers!**

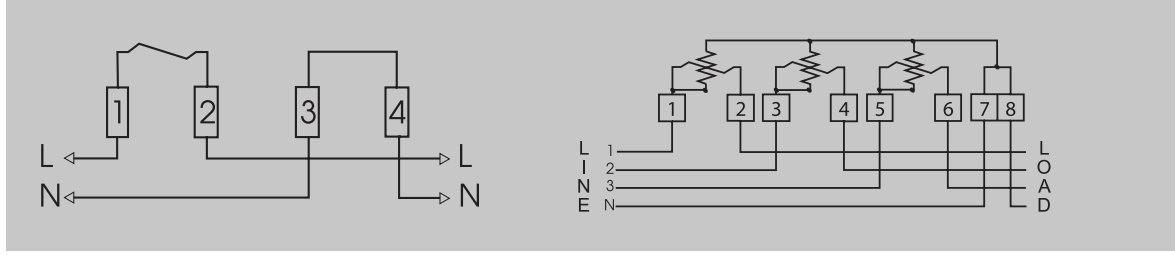

**SINGLE-PHASE ELECTRONIC METERS**

**THREE-PHASE ELECTRONIC METERS**

	<b>SINGLE-PHASE ELECTRONIC METERS</b>	<b>THREE-PHASE ELECTRONIC METERS</b>
<b>MODEL NAME</b>	AEL.MF.11	AEL.TF.16-2
<b>MODEL DEFINITION</b>	Single Phase, 2 wires, 4 tariffs, demandmeter property, outdoor, active electronic electricity meter	Single Phase, 2 wires, 4 tariffs, demandmeter, outdoor, Pre-paid active electronic electrical meter
<b>ACCURACY (TS EN 504701-1)</b>	B	B
<b>REFERENCE VOLTAGE</b>	230V	3X230/400V
<b>VOLTAGE TOLERANCE</b>	0,8Un-1,5Un	0,8Un-1,5Un
<b>REFERENCE FREQUENCY (Fn)</b>	50Hz ±%5	50Hz ±%5
<b>STARTING CURRENT (Ist)</b>	20mA (0,04 Ib)	20mA (0,04 Itr)
<b>MINIMUM CURRENT (Imin)</b>	0,25 A	0,25 A
<b>TRANSLANT CURRENT (Itr)</b>	0,5 A	0,5 A
<b>REFERENCE CURRENT (Ib)</b>	5 A	5 A
<b>MAXIMUM CURRENT (Imax)</b>	90 A	100 A
<b>IP CLASS</b>	IP54 Outdoor	IP54
<b>PROTECTION CLASS</b>	2	2
<b>RELATIVE HUMIDITY</b>	%95	%95
<b>TEMPERATURE CONDITION</b>	-40 °C, +80 °C (3K7)	-40 °C, +70 °C
<b>CONNECTION TYPE</b>	Direct Connection	-
<b>MECHANICAL ENVIRONMENT CLASS</b>	M1 (2014/32/EU Directive)	M1 (2014/32/EU Directive)
<b>ELECTROMAGNETIC ENVIRONMENT CLASS</b>	E2 (201/32/EU Directive)	E2 (201/32/EU Directive)
<b>WORK CONDITION</b>	Non-Condensing Humidity	Non-Condensing Humidity
<b>POWER CONSUMPTION-VOLTAGE CIRCUIT</b>	≤ 2W	≤ 2W, ≤ 10VA
<b>POWER CONSUMPTION-CURRENT CIRCUIT</b>	≤ 4 VA	≤ 4 VA
<b>SURGE WITHSTAND</b>	6kV	12kV
<b>ESD VOLTAGE SENSITIVITY</b>	By direct contact: 8kV - By air: 15kV	By direct contact: 8kV - By air: 15kV
<b>METER IMPULSE CONSTANT</b>	1600 imp/kWh	1000 imp/kWh
<b>LCD SCREEN</b>	6+3 Digit	6+3 Digit
<b>COMMUNICATION RATES</b>	300-4800 Boud (IEC 62056-21 Model C)	300-4800 Boud (IEC 62056-21)
<b>INTERFACE</b>	Optical Port	Optical Port (IEC 62056-21)
<b>BATTERY LIFE</b>	≥ 10 year	≥ 10 year
<b>BATTERY LIFE FOR RTC</b>	≥ 10 year	≥ 10 year
<b>SHELF LIFE FOR METER</b>	≥ 4 year	≥ 4 year
<b>RTC SENSITIVITY</b>	0,5 s/date (room temperature) (TS EN 62054-21)	0,5 s/date (room temperature) (TS EN 62054-21)
<b>LOAD STORAGE CAPACITY</b>	1 year	1 year
<b>RELATED STANDARDS</b>	TS EN 50470-1, TS EN 50470-3	TS EN 50470-1, TS EN 50470-3

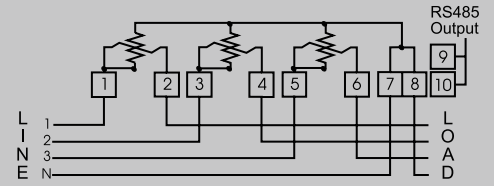
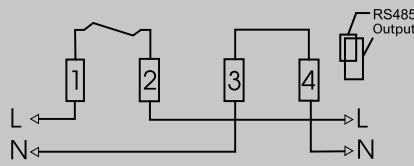
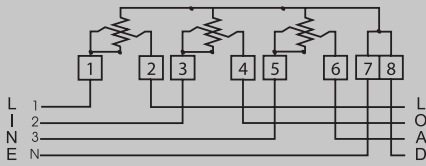
**THREE-PHASE ELECTRONIC METERS****SINGLE-PHASE ELECTRONIC METERS****THREE-PHASE ELECTRONIC METERS**

AEL.TF.32	AEL.TF.32 (RS485 Communication Output)	AEL.TF.22 (RS485 Communication Output)
Single Phase, 2 wires, 4 tariffs, demandmeter property, outdoor, active electronic electrical meter	Single Phase, 2 wires, 4 tariffs, demandmeter, outdoor, RS485 Communication, active electronic meter	3 Phase, 4 wires, 4 tariffs, demandmeter, direct connected, outdoor, RS485 Communication, active electronic electricity meter
B	B	B
3X230/400V	230V	3X230/400V
0,8Un-1,5Un	0,8Un-1,5Un	0,8Un-1,5Un
50Hz ±%5	50Hz ±%5	50Hz ±%5
20mA (0,04 ltr)	20mA (0,04 lb)	20mA (0,04 ltr)
0,25 A	0,25 A	0,25 A
0,5 A	0,5 A	0,5 A
5 A	5 A	5 A
100 A	90 A	100 A
IP54	IP54 Outdoor	IP54
2	2	2
%95	%95	%95
-40 °C, +70 °C	-40 °C, +70 °C (3K7)	-40 °C, +70 °C
-	Direct Connection	-
M1 (2014/32/EU Directive)	M1 (2014/32/EU Directive)	M1 (2014/32/EU Directive)
E2 (201/32/EU Directive)	E2 (201/32/EU Directive)	E2 (201/32/EU Directive)
Non-Condensing Humidity	Non-Condensing Humidity	Non-Condensing Humidity
≤ 2W, ≤ 10VA	≤ 2W, ≤ 10VA	≤ 2W, ≤ 10VA
≤ 4 VA	≤ 4 VA	≤ 4 VA
12kV	12kV	12kV
By direct contact: 8kV - By air: 15kV	By direct contact: 8kV - By air: 15kV	By direct contact: 8kV - By air: 15kV
1000 imp/kWh	1000 imp/kWh	1000 imp/kWh
6+3 Digit	6+3 Digit	6+3 Digit
300-4800 Boud (IEC 62056-21)	Optical Port 300-4800, RS485 300-9600 (IEC 62056-21 Mode C)	Optical Port 300-4800 Boud, RS485 300-9600 (IEC 62056-21)
Optical Port (IEC 62056-21)	Optical Port, RS485	Optical Port, (IEC 62056-21), RS485
≥ 10 year	≥ 10 year	≥ 10 year
≥ 10 year	≥ 10 year	≥ 10 year
≥ 4 year	≥ 4 year	≥ 4 year
0,5 s/date (room temperature) (TS EN 62054-21)	0,5 s/date (room temperature) (TS EN 62054-21)	0,5 s/date (room temperature) (TS EN 62054-21)
1 year	1 year	1 year
TS EN 50470-1, TS EN 50470-3	TS EN 50470-1, TS EN 50470-3	TS EN 50470-1, TS EN 50470-3

# Aydınlatma ürünlerimizin teknik özellikleri

Technical Specification of  
Lighting Products



LED Sensörlü Armatür  
LED Sensor Fixture



LED Armatür  
LED Armature

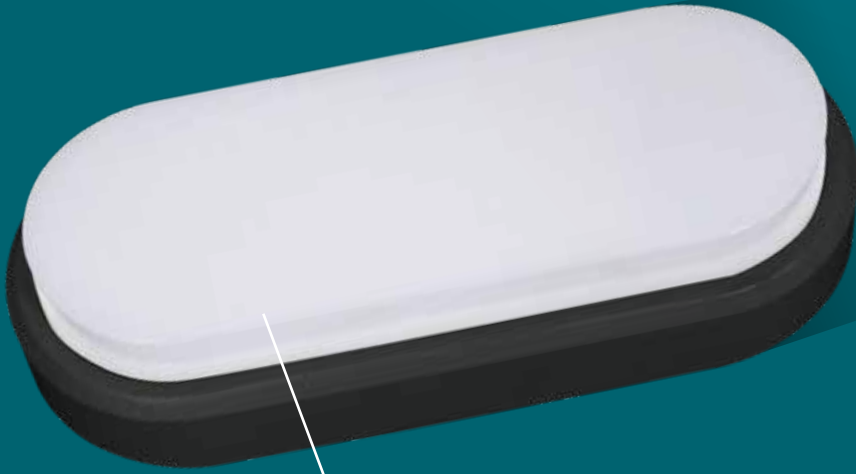

LED Armatür  
LED Armature





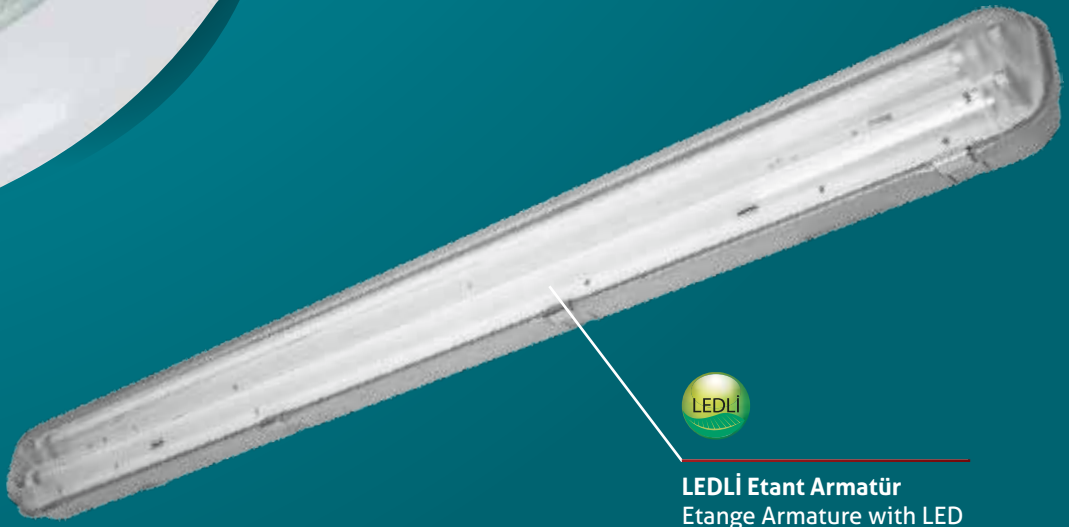

**LEDLİ Etant Armatür**  
Etange Armature with LED





## KAFESLİ ARMATÜR - CAGED LIGHTING

Ürün Kodu - Product Code

IP 40



**AK-108-İ 11**

Güç - Power

1 X E27 MAX. 26W

Kutu - Box

48



## SENSÖRLÜ ARMATÜR SENSORED ARMATURE

Ürün Kodu - Product Code

**AK-02**

Güç - Power

2 X 25 W

Kutu - Box

10

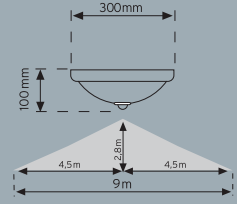

## PİLLİ SENSÖRLÜ ARMATÜR BATTERY SENSORED ARMATURE



Ürün Kodu - Product Code

**AK-03**

Güç - Power

2 X 25 W

Kutu - Box

10

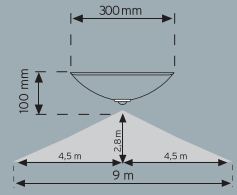

## LEDLİ SENSÖRLÜ ARMATÜR LED SENSORED ARMATURE



Ürün Kodu - Product Code

**AK-04**

Güç - Power

2 X 25 W

Kutu - Box

10

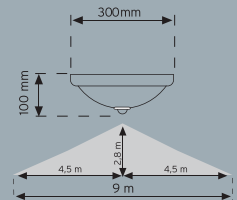

## LEDLİ PİLLİ SENSÖRLÜ ARMATÜR LED BATTERY SENSORED ARMATURE



Ürün Kodu - Product Code

**AK-05**

Güç - Power

2 X 25 W

Kutu - Box

10

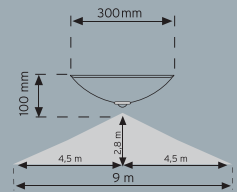

**YENİ ÜRÜN**  
NEW PRODUCT



## UFO LED ARMATÜRÜ - UFO LIGHT

Ürün Kodu - Product Code  
**AK-UFO18**

Ölçü - Size 26 CM

Lümen - Lumen 1800

Güç - Power 18 WATT

Kutu/Koli - Box/Carton 1/20

**YENİ ÜRÜN**  
NEW PRODUCT



## PLASTİK SENSÖRLÜ ARMATÜR PLASTIC SENSOR FIXTURE



Ürün Kodu - Product Code  
**AK-S201**

Ölçü - Size 30 X 7,5 CM

Duy - Lampholder LED

Güç - Power 18 WATT

Kutu/Koli - Box/Carton 1/14

**YENİ ÜRÜN**  
NEW PRODUCT



## PLASTİK E27 SENSÖRLÜ ARMATÜR PLASTIC E27 SENSOR FIXTURE

Ürün Kodu - Product Code  
**AK-S205**

Ölçü - Size 30 X 10 CM

Body / Diffusse Iron / Glass

Duy - Lampholder E27

Güç - Power 2 X 25

Kutu/Koli - Box/Carton 1/12

**YENİ ÜRÜN**  
NEW PRODUCT



## PLASTİK E27 SENSÖRLÜ ARMATÜR PLASTIC E27 SENSOR FIXTURE

Ürün Kodu - Product Code  
**AK-S206**

Ölçü - Size 30 X 10 CM

Body / Diffusse PC / PC

Duy - Lampholder E27

Güç - Power 2 X 25

Kutu/Koli - Box/Carton 1/12

**YENİ ÜRÜN**  
NEW PRODUCT



### AK-EN370W

Ölçü - Size 30 X 10 CM

Body / Diffusse PC/ PC

Güç - Power E - 27

Kutu/Koli - Box/Carton 1/10

**YENİ ÜRÜN**  
NEW PRODUCT



### AK-EN370B

Ölçü - Size 30 X 10 CM

Body / Diffusse PC/ PC

Güç - Power E - 27

Kutu/Koli - Box/Carton 1/10

**YENİ ÜRÜN**  
NEW PRODUCT



### AK-EN370G

Ölçü - Size 30 X 10 CM

Body / Diffusse PC/ PC

Güç - Power E - 27

Kutu/Koli - Box/Carton 1/10

**YENİ ÜRÜN**  
NEW PRODUCT



### AK-EN370LO

Ölçü - Size 30 X 10 CM

Body / Diffusse PC/ PC

Güç - Power 18 WATT

Kutu/Koli - Box/Carton 1/10

**YENİ ÜRÜN**  
NEW PRODUCT**AK-01 MINI**Ölçü - Size  $\varnothing$ : 21,5 / H: 9,8 CM

Güç - Power 1 X 60 WATT

Kutu - Box 4/48

**YENİ ÜRÜN**  
NEW PRODUCT**AK-02 MEGA**Ölçü - Size  $\varnothing$ : 24,2 / H: 10 CM

Güç - Power 1 X 60 WATT

Kutu - Box 4/48

**YENİ ÜRÜN**  
NEW PRODUCT**AK-403**Ölçü - Size  $\varnothing$ : 24,2 / H: 10 CM

Güç - Power 1 X 60 WATT

Kutu - Box 4/48

**YENİ ÜRÜN**  
NEW PRODUCT**AK-404**Ölçü - Size  $\varnothing$ : 24,2 / H: 10 CM

Güç - Power 1 X 60 WATT

Kutu - Box 4/48



**YENİ ÜRÜN**  
NEW PRODUCT

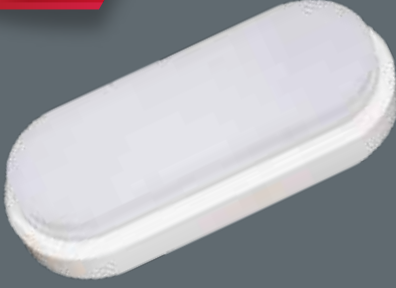

**18 W VİZYON LED ARMATÜR (OVAL)**



Ürün Kodu - Product Code

**AK 348185**

Ambalaj Miktarı - Package total 1

Koli Adet - Box Pcs. 24

**YENİ ÜRÜN**  
NEW PRODUCT



**28 W VİZYON LED ARMATÜR (YUVARLAK)**



Ürün Kodu - Product Code

**AK 348304**

Ambalaj Miktarı - Package total 1

Koli Adet - Box Pcs. 24

**YENİ ÜRÜN**  
NEW PRODUCT



**36 W VİZYON LED ARMATÜR (YUVARLAK)**



Ürün Kodu - Product Code

**AK 348186**

Ambalaj Miktarı - Package total 1

Koli Adet - Box Pcs. 24

**YENİ ÜRÜN**  
NEW PRODUCT



**54 W VİZYON LED ARMATÜR (YUVARLAK)**



Ürün Kodu - Product Code

**AK 348302**

Ambalaj Miktarı - Package total 1

Koli Adet - Box Pcs. 24

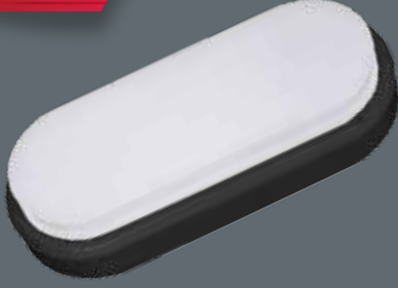
**YENİ ÜRÜN**  
 NEW PRODUCT

**18 W VİZYON LED ARMATÜR (OVAL)**

Ürün Kodu - Product Code

**AK 348185**

Ürün Renkleri - Product Colors



Ambalaj Miktarı - Package total

1

Koli Adet - Box Pcs.

24

**YENİ ÜRÜN**  
 NEW PRODUCT

**28 W VİZYON LED ARMATÜR (YUVARLAK)**

Ürün Kodu - Product Code

**AK 348305**

Ürün Renkleri - Product Colors



Ambalaj Miktarı - Package total

1

Koli Adet - Box Pcs.

24

**YENİ ÜRÜN**  
 NEW PRODUCT

**36 W VİZYON LED ARMATÜR (YUVARLAK)**

Ürün Kodu - Product Code

**AK 348186**

Ürün Renkleri - Product Colors



Ambalaj Miktarı - Package total

1

Koli Adet - Box Pcs.

24

**YENİ ÜRÜN**  
 NEW PRODUCT

**54 W VİZYON LED ARMATÜR (YUVARLAK)**

Ürün Kodu - Product Code

**AK 348303**

Ürün Renkleri - Product Colors



Ambalaj Miktarı - Package total

1

Koli Adet - Box Pcs.

24

## LED ETANJ ARMATÜR - LED ETANJ FIXTURE



KOD - CODE	ÖLÇÜ - SIZE	GÜÇ - POWER	KUTU / KOLİ - BOX/CARTOON
AK-ETJLED9W	60 CM	9 WATT	4/32
AK-ETJLED18W	60 CM	18 WATT	2/24
AK-ETJLED36W	120 CM	36 WATT	2/18
AK-ETJLED54W	120 CM	54 WATT	2/12
AK-ETJLED72W	120 CM	72 WATT	2/12

## ETANJ ARMATÜR T5 - WATERPROOF LUMINAIRES T5



KOD - CODE	ÖLÇÜ - SIZE	BALAST	GÜÇ - POWER	KUTU / KOLİ - BOX/CARTOON
AK-ETJ114	60 CM	Electronic	1 X 14 WATT	4/32
AK-ETJ214	60 CM	Electronic	2 X 14 WATT	2/24
AK-ETJ154	120 CM	Electronic	1 X 54 WATT	2/18
AK-ETJ254	120 CM	Electronic	2 X 54 WATT	2/12
AK-ETJ9X1	60 CM	Led Tube	9 WATT	4/32
AK-ETJ9X2	60 CM	Led Tube	18 WATT	2/24
AK-ETJ18X1	120 CM	Led Tube	18 WATT	2/18
AK-ETJ18X2	120 CM	Led Tube	36 WATT	2/12

## ETANJ ARMATÜR T8 - WATERPROOF LUMINAIRES T8



KOD - CODE	ÖLÇÜ - SIZE	BALAST	GÜÇ - POWER	KUTU / KOLİ - BOX/CARTOON
AK-ETJ118E	60 CM	Electronic	1 X 18 WATT	4/32
AK-ETJ218E	60 CM	Electronic	2 X 18 WATT	2/24
AK-ETJ136E	120 CM	Electronic	1 X 36 WATT	2/18
AK-ETJ236E	120 CM	Electronic	2 X 36 WATT	2/12
AK-ETJ118OP	60 CM	Osram / Philips	1 X 18 WATT	4/32
AK-ETJ218OP	60 CM	Osram / Philips	2 X 18 WATT	2/24
AK-ETJ136OP	120 CM	Osram / Philips	1 X 36 WATT	2/18
AK-ETJ236OP	120 CM	Osram / Philips	2 X 36 WATT	2/12

## TCS TİPİ ARMATÜR T-8 / T/5 - SCHOOL LUMINAIRES T-8 / T/5

**YENİ ÜRÜN**  
**NEW PRODUCT**



KOD - CODE	ÖLÇÜ - SIZE	BALAST	GÜÇ - POWER	KUTU / KOLİ - BOX/CARTOON
AK-TSC118	60 CM	Electronic	1 X 18 WATT	4/32
AK-TSC218	60 CM	Electronic	2 X 18 WATT	2/24
AK-TSC136	120 CM	Electronic	1 X 36 WATT	2/18
AK-TSC236	120 CM	Electronic	2 X 36 WATT	2/12

YENİ ÜRÜN  
NEW PRODUCT

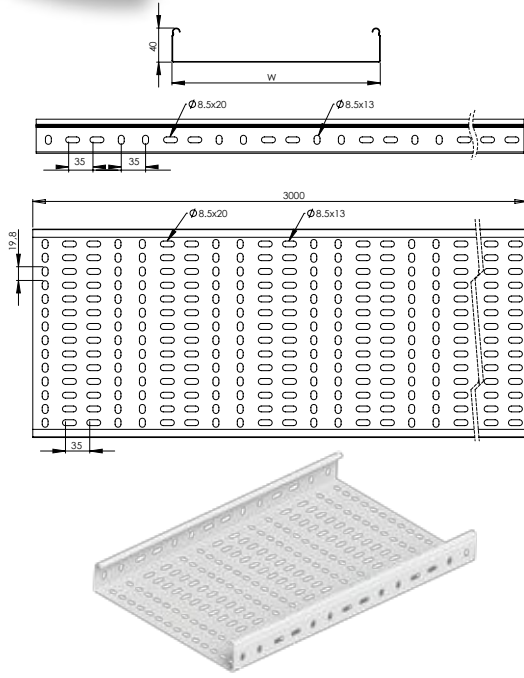

#### H40

SİPARİŞ KODU ORDER CODE	STOK KODU STOCK CODE	H mm	W mm	T mm	AĞIRLIK (KG/MT) WEIGHT (KG/MT) (P.G to ISO 10346)
A05-04A-08 PG	01002A0504A08PG	40	50	0,8	0,650
A08-04A-10 PG	01002A0804A10PG	40	80	1,0	1,040
A10-04A-08 PG	01002A1004A08PG	40	100	0,8	0,890
A12-04A-10 PG	01002A1204A10PG	40	120	1,0	1,250
A15-04A-15 PG	01002A1504A15PG	40	150	1,5	2,210
A16-04A-10 PG	01002A1604A10PG	40	160	1,0	1,460
A20-04A-10 PG	01002A2004A10PG	40	200	1,0	1,680
A22-04A-10 PG	01002A2204A10PG	40	225	1,0	1,810
A25-04A-10 PG	01002A2504A10PG	40	250	1,0	1,950
A30-04A-10 PG	01002A3004A10PG	40	300	1,0	2,210
A40-04A-10 PG	01002A4004A10PG	40	400	1,0	2,750
A45-04A-12 PG	01002A4504A12PG	40	450	1,2	3,700
A50-04A-12 PG	01002A5004A12PG	40	500	1,2	4,030

YENİ ÜRÜN  
NEW PRODUCT

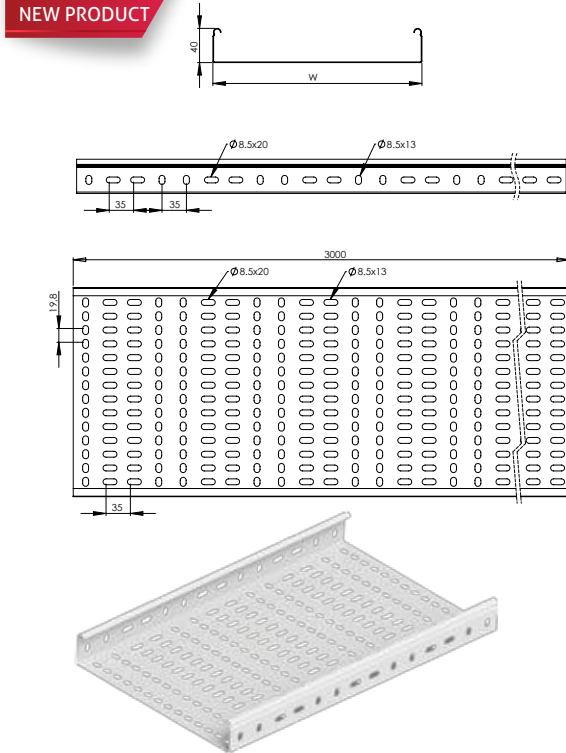

#### H40

SİPARİŞ KODU ORDER CODE	STOK KODU STOCK CODE	H mm	W mm	T mm	AĞIRLIK (KG/MT) WEIGHT (KG/MT) (H.D.G to ISO 1461)
A05-04A-08 HDG	01002A0504A08HDG	40	50	0,8	0,660
A08-04A-10 HDG	01002A0804A10HDG	40	80	1,0	1,070
A10-04A-08 HDG	01002A1004A08HDG	40	100	0,8	0,880
A12-04A-10 HDG	01002A1204A10HDG	40	120	1,0	1,300
A16-04A-10 HDG	01002A1604A10HDG	40	160	1,0	1,520
A20-04A-10 HDG	01002A2004A10HDG	40	200	1,0	1,740
A22-04A-10 HDG	01002A2204A10HDG	40	225	1,0	1,880
A25-04A-10 HDG	01002A2504A10HDG	40	250	1,0	2,010
A30-04A-10 HDG	01002A3004A10HDG	40	300	1,0	2,290
A40-04A-10 HDG	01002A4004A10HDG	40	400	1,0	2,840
A45-04A-12 HDG	01002A4504A12HDG	40	450	1,2	3,920
A50-04A-12 HDG	01002A5004A12HDG	40	500	1,2	4,270

1,0 - 1,2 - 1,5 - 2,0 mm Kalınlıkları mevcuttur - 1,0 - 1,2 - 1,5 - 2,0 Available in thicknesses

#### AÇIKLAMALAR

- 1- Kablo kanalı standart uzunluk 3000 mm'dir.
- 2- Kablo kanalı bağlantısı için 2 adet ek elemanı kullanılmalıdır.
- 3- Ek Elemanı bağlantısı için 4 adet M8x15 civata somun kullanılmalıdır.
- 4- Paslanmaz sac'tan üretimimiz vardır.
- 5- Lütfen siparişlerinizde ürün kodu ve kaplama şeklini belirtiniz.
- 6- Farklı sac kalınlıklarında üretim yapılabilmektedir.

#### DESCRIPTIONS

- 1- Cable tray standard length is 3000 mm.
- 2- Each cable tray needs 2 pcs straight connectors.
- 3- Each straight connector needs 4 sets of M8x15 nuts&bolts.
- 4- We use stainless steel material upon request.
- 5- Please indicate order code and the type of coating in your orders.
- 6- Different sheet thicknesses can be produced.

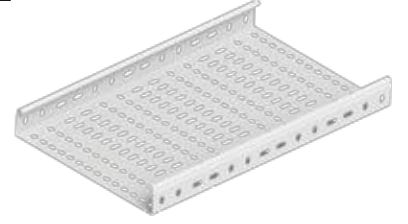
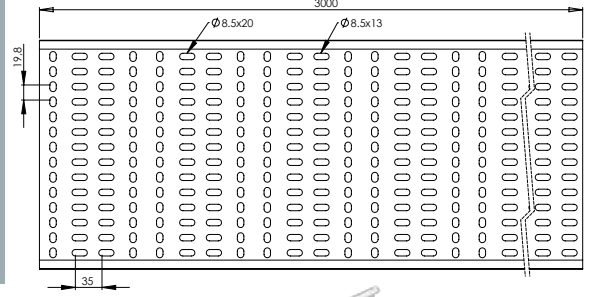
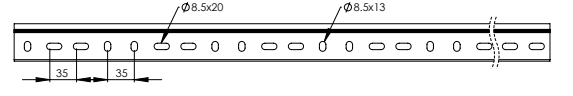

**YENİ ÜRÜN**  
**NEW PRODUCT**

**H50**

SİPARİŞ KODU ORDER CODE	STOK KODU STOCK CODE	H mm	W mm	T mm	AĞIRLIK (KG/MT) WEIGHT (KG/MT) (PG to ISO 10346)
A05-05A-08 PG	01002A0505A08PG	50	50	0,8	0,760
A08-05A-10 PG	01002A0805A10PG	50	80	1,0	1,180
A10-05A-08 PG	01002A1005A08PG	50	100	0,8	1,000
A12-05A-10 PG	01002A1205A10PG	50	120	1,0	1,400
A15-05A-15 PG	01002A1505A15PG	50	150	1,5	2,440
A16-05A-10 PG	01002A1605A10PG	50	160	1,0	1,610
A20-05A-10 PG	01002A2005A10PG	50	200	1,0	1,820
A22-05A-10 PG	01002A2205A10PG	50	225	1,0	1,960
A25-05A-10 PG	01002A2505A10PG	50	250	1,0	2,090
A30-05A-10 PG	01002A3005A10PG	50	300	1,0	2,360
A40-05A-10 PG	01002A4005A10PG	50	400	1,0	2,890
A45-05A-12 PG	01002A4505A12PG	50	450	1,2	3,880
A50-05A-12 PG	01002A5005A12PG	50	500	1,2	4,210

**H50**

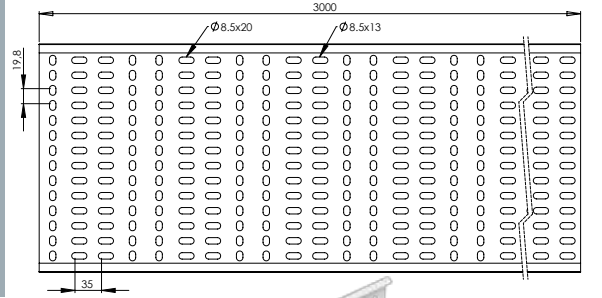
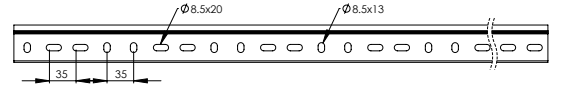
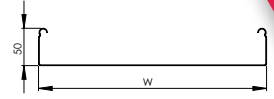
SİPARİŞ KODU ORDER CODE	STOK KODU STOCK CODE	H mm	W mm	T mm	AĞIRLIK (KG/MT) WEIGHT (KG/MT) (H.D.G to ISO 1461)
A05-05A-08 HDG	01002A0505A08HDG	50	50	0,8	0,780
A08-05A-10 HDG	01002A0805A10HDG	50	80	1,0	1,220
A10-05A-08 HDG	01002A1005A08HDG	50	100	0,8	1,000
A12-05A-10 HDG	01002A1205A10HDG	50	120	1,0	1,440
A15-05A-20 HDG	01002A1505A20HDG	50	150	2,0	3,420
A16-05A-10 HDG	01002A1605A10HDG	50	160	1,0	1,670
A20-05A-10 HDG	01002A2005A10HDG	50	200	1,0	1,890
A22-05A-10 HDG	01002A2205A10HDG	50	225	1,0	2,020
A25-05A-10 HDG	01002A2505A10HDG	50	250	1,0	2,160
A30-05A-10 HDG	01002A3005A10HDG	50	300	1,0	2,440
A40-05A-10 HDG	01002A4005A10HDG	50	400	1,0	2,990
A45-05A-12 HDG	01002A4505A12HDG	50	450	1,2	4,110
A50-05A-12 HDG	01002A5005A12HDG	50	500	1,2	4,450
A60-05A-12 HDG	01002A6005A12HDG	50	600	1,2	5,150



1,0 - 1,2 - 1,5 - 2,0 mm Kalınlıkları mevcuttur - 1,0 - 1,2 - 1,5 - 2,0 Available in thicknesses

**AÇIKLAMALAR**

- 1- Kablo kanalı standart uzunluk 3000 mm'dir.
- 2- Kablo kanalı bağlantısı için 2 adet ek elemanı kullanılmalıdır.
- 3- Ek Elemanı bağlantısı için 4 adet M8x15 civata somun kullanılmalıdır.
- 4- Paslanmaz sac'tan üretimimiz vardır.
- 5- Lütfen siparişlerinizde ürün kodu ve kaplama şeklini belirtiniz.
- 6- Farklı sac kalınlıklarında üretim yapılabilir.

**DESCRIPTIONS**

- 1- Cable tray standard length is 3000 mm.
- 2- Each cable tray needs 2 pcs straight connectors.
- 3- Each straight connector needs 4 sets of M8x15 nuts&bolts.
- 4- We use stainless steel material upon request.
- 5- Please indicate order code and the type of coating in your orders.
- 6- Different sheet thicknesses can be produced.

YENİ ÜRÜN  
NEW PRODUCT

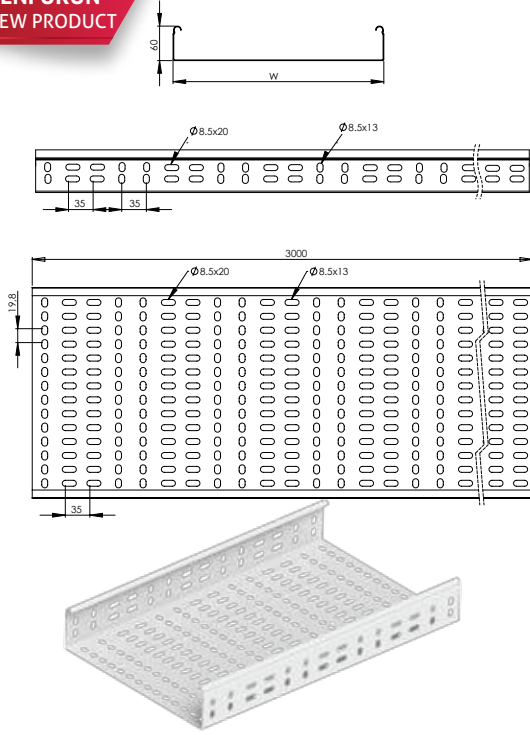

### H60

SİPARİŞ KODU ORDER CODE	STOK KODU STOCK CODE	H mm	W mm	T mm	AĞIRLIK (KG/MT) WEIGHT (KG/MT) (P.G to ISO 10346)
A08-06A-10 PG	01002A0806A10PG	60	80	1,0	1,180
A10-06A-08 PG	01002A1006A08PG	60	100	0,8	1,000
A12-06A-10 PG	01002A1206A10PG	60	120	1,0	1,400
A15-06A-15 PG	01002A1506A15PG	60	150	1,5	2,440
A16-06A-10 PG	01002A1606A10PG	60	160	1,0	1,610
A20-06A-10 PG	01002A2006A10PG	60	200	1,0	1,820
A22-06A-10 PG	01002A2206A10PG	60	225	1,0	1,960
A25-06A-10 PG	01002A2506A10PG	60	250	1,0	2,090
A30-06A-10 PG	01002A3006A10PG	60	300	1,0	2,360
A40-06A-10 PG	01002A4006A10PG	60	400	1,0	2,890
A45-06A-12 PG	01002A4506A12PG	60	450	1,2	3,880
A50-06A-12 PG	01002A5006A12PG	60	500	1,2	4,210
A60-06A-12 PG	01002A6006A12PG	60	600	1,2	4,860

Ek Elemanı bağlantısı için 4 adet M8x15 civata somun kullanılmalıdır.  
Each straight connector needs 4 sets of M8x15 nuts&bolts.

YENİ ÜRÜN  
NEW PRODUCT

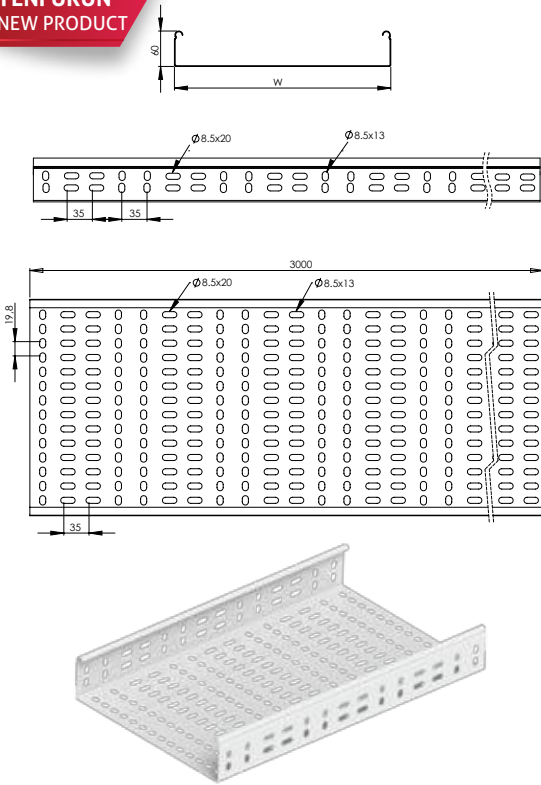

### H60

SİPARİŞ KODU ORDER CODE	STOK KODU STOCK CODE	H mm	W mm	T mm	AĞIRLIK (KG/MT) WEIGHT (KG/MT) (H.D.G to ISO 1461)
A08-06A-10 HDG	01002A0806A10HDG	60	80	1,0	1,220
A10-06A-08 HDG	01002A1006A08HDG	60	100	0,8	1,000
A12-06A-10 HDG	01002A1206A10HDG	60	120	1,0	1,440
A15-06A-15 HDG	01002A1506A15HDG	60	150	1,5	2,540
A16-06A-10 HDG	01002A1606A10HDG	60	160	1,0	1,670
A20-06A-10 HDG	01002A2006A10HDG	60	200	1,0	1,890
A22-06A-10 HDG	01002A2206A10HDG	60	225	1,0	2,020
A25-06A-10 HDG	01002A2506A10HDG	60	250	1,0	2,160
A30-06A-10 HDG	01002A3006A10HDG	60	300	1,0	2,440
A40-06A-10 HDG	01002A4006A10HDG	60	400	1,0	2,990

Ek Elemanı bağlantısı için 8 adet M8x15 civata somun kullanılmalıdır.  
Each straight connector needs 8 sets of M8x15 nuts&bolts.

1,0 - 1,2 - 1,5 - 2,0 mm Kalınlıkları mevcuttur - 1,0 - 1,2 - 1,5 - 2,0 Available in thicknesses

### AÇIKLAMALAR

- 1- Kablo kanalı standart uzunluk 3000 mm'dir.
- 2- Kablo kanalı bağlantısı için 2 adet ek elemanı kullanılmalıdır.
- 3- Paslanmaz sac'tan üretimimiz vardır.
- 4- Lütfen siparişlerinizde ürün kodu ve kaplama şeklini belirtiniz.
- 5- Farklı sac kalınlıklarında üretim yapılabilmektedir.

### DESCRIPTIONS

- 1- Cable tray standard length is 3000 mm.
- 2- Each cable tray needs 2 pcs straight connectors.
- 3- We use stainless steel material upon request.
- 4- Please indicate order code and the type of coating in your orders.
- 5- Different sheet thicknesses can be produced.

**YENİ ÜRÜN**  
NEW PRODUCT

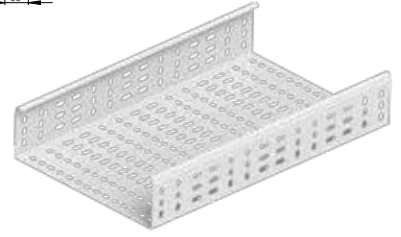
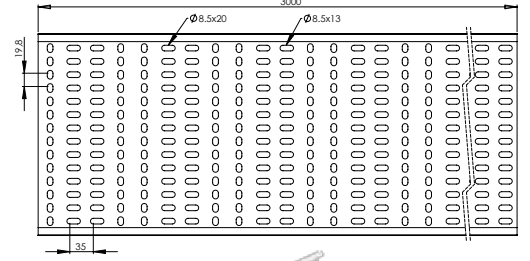
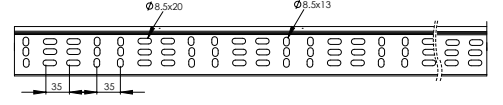

## H80

SİPARİŞ KODU ORDER CODE	STOK KODU STOCK CODE	H mm	W mm	T mm	AĞIRLIK (KG/MT) WEIGHT (KG/MT) (PG to ISO 10346)
A08-08A-10 PG	01002A0808A10PG	80	80	1,0	1,460
A10-08A-08 PG	01002A1008A08PG	80	100	0,8	1,210
A12-08A-10 PG	01002A1208A10PG	80	120	1,0	1,680
A15-08A-15 PG	01002A1508A15PG	80	150	1,5	2,890
A16-08A-10 PG	01002A1608A10PG	80	160	1,0	1,890
A20-08A-10 PG	01002A2008A10PG	80	200	1,0	2,110
A22-08A-10 PG	01002A2208A10PG	80	225	1,0	2,240
A25-08A-10 PG	01002A2508A10PG	80	250	1,0	2,370
A30-08A-10 PG	01002A3008A10PG	80	300	1,0	2,640
A40-08A-10 PG	01002A4008A10PG	80	400	1,0	3,170

## H75

SİPARİŞ KODU ORDER CODE	STOK KODU STOCK CODE	H mm	W mm	T mm	AĞIRLIK (KG/MT) WEIGHT (KG/MT)
A20-075A-15 HDG	01002A2008A15HDG	75	200	1,5	3,575

## H80

SİPARİŞ KODU ORDER CODE	STOK KODU STOCK CODE	H mm	W mm	T mm	AĞIRLIK (KG/MT) WEIGHT (KG/MT) (H.D.G to ISO 1461)
A08-08A-10 HDG	01002A0808A10HDG	80	80	1,0	1,520
A10-08A-08 HDG	01002A1008A08HDG	80	100	0,8	1,210
A12-08A-10 HDG	01002A1208A10HDG	80	120	1,0	1,740
A15-08A-15 HDG	01002A1508A15HDG	80	150	1,5	3,000
A16-08A-10 HDG	01002A1608A10HDG	80	160	1,0	1,960
A20-08A-10 HDG	01002A2008A10HDG	80	200	1,0	2,180
A22-08A-10 HDG	01002A2208A10HDG	80	225	1,0	2,320
A25-08A-10 HDG	01002A2508A10HDG	80	250	1,0	2,460
A30-08A-10 HDG	01002A3008A10HDG	80	300	1,0	2,730
A40-08A-10 HDG	01002A4008A10HDG	80	400	1,0	3,280

**YENİ ÜRÜN**  
NEW PRODUCT

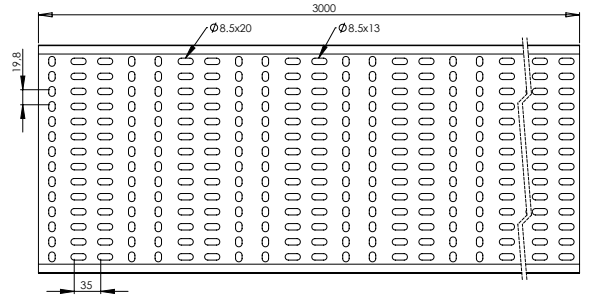
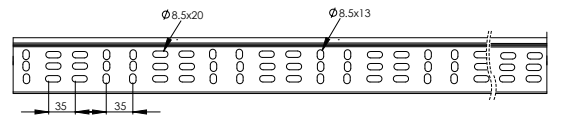

1,0 - 1,2 - 1,5 - 2,0 mm Kalınlıkları mevcuttur - 1,0 - 1,2 - 1,5 - 2,0 Available in thicknesses

## AÇIKLAMALAR

- 1- Kablo kanalı standart uzunluk 3000 mm'dir.
- 2- Kablo kanalı bağlantısı için 2 adet ek elemanı kullanılmalıdır.
- 3- Ek Elemanı bağlantısı için 4 adet M8x15 civata somun kullanılmalıdır.
- 4- Paslanmaz sactan üretimimiz vardır.
- 5- Lütfen siparişlerinizde ürün kodu ve kaplama şeklini belirtiniz.
- 6- Farklı sac kalınlıklarında üretim yapılabilir.

## DESCRIPTIONS

- 1- Cable tray standard length is 3000 mm.
- 2- Each cable tray needs 2 pcs straight connectors.
- 3- Each straight connector needs 4 sets of M8x15 nuts&bolts.
- 4- We use stainless steel material upon request.
- 5- Please indicate order code and the type of coating in your orders.
- 6- Different sheet thicknesses can be produced.

YENİ ÜRÜN  
NEW PRODUCT

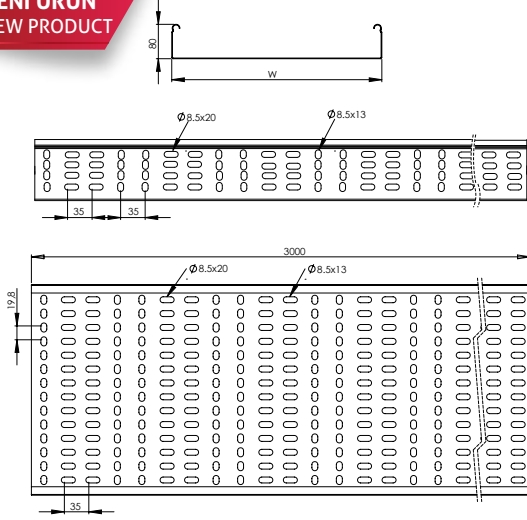

### H100

SİPARİŞ KODU ORDER CODE	STOK KODU STOCK CODE	H mm	W mm	T mm	AĞIRLIK (KG/MT) WEIGHT (KG/MT) (P.G to ISO 10346)
<b>A10-10A-08 PG</b>	01002A1010A08PG	100	100	0,8	1,300
<b>A12-10A-10 PG</b>	01002A1210A10PG	100	120	1,0	1,890
<b>A15-10A-15 PG</b>	01002A1510A15PG	100	150	1,5	3,220
<b>A16-10A-10 PG</b>	01002A1610A10PG	100	160	1,0	2,110
<b>A20-10A-10 PG</b>	01002A2010A10PG	100	200	1,0	2,320
<b>A22-10A-10 PG</b>	01002A2210A10PG	100	225	1,0	2,450
<b>A25-10A-10 PG</b>	01002A2510A10PG	100	250	1,0	2,590
<b>A30-10A-10 PG</b>	01002A3010A10PG	100	300	1,0	2,850
<b>A40-10A-10 PG</b>	01002A4010A10PG	100	400	1,0	3,390



YENİ ÜRÜN  
NEW PRODUCT

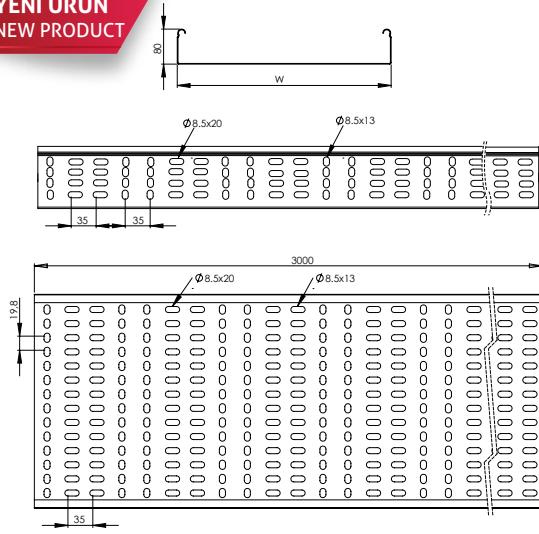

### H100

SİPARİŞ KODU ORDER CODE	STOK KODU STOCK CODE	H mm	W mm	T mm	AĞIRLIK (KG/MT) WEIGHT (KG/MT) (H.D.G to ISO 1461)
<b>A10-10A-08 HDG</b>	01002A1010A08HDG	100	100	0,8	1,380
<b>A12-10A-10 HDG</b>	01002A1210A10HDG	100	120	1,0	1,960
<b>A15-10A-15 HDG</b>	01002A1510A15HDG	100	150	1,5	3,350
<b>A16-10A-10 HDG</b>	01002A1610A10HDG	100	160	1,0	2,180
<b>A20-10A-10 HDG</b>	01002A2010A10HDG	100	200	1,0	2,400
<b>A22-10A-10 HDG</b>	01002A2210A10HDG	100	225	1,0	2,540
<b>A25-10A-10 HDG</b>	01002A2510A10HDG	100	250	1,0	2,680
<b>A30-10A-10 HDG</b>	01002A3010A10HDG	100	300	1,0	2,950
<b>A40-10A-10 HDG</b>	01002A4010A10HDG	100	400	1,0	3,510



1,0 - 1,2 - 1,5 - 2,0 mm Kalınlıkları mevcuttur - 1,0 - 1,2 - 1,5 - 2,0 Available in thicknesses

## AÇIKLAMALAR

- 1- Kablo kanalı standart uzunluk 3000 mm'dir.
- 2- Kablo kanalı bağlantısı için 2 adet ek elemanı kullanılmalıdır.
- 3- Ek Elemanı bağlantısı için 4 adet M8x15 civata somun kullanılmalıdır.
- 4- Paslanmaz sac'tan üretimimiz vardır.
- 5- Lütfen siparişlerinizde ürün kodu ve kaplama şeklini belirtiniz.
- 6- Farklı sac kalınlıklarında üretim yapılabilmektedir.

## DESCRIPTIONS

- 1- Cable tray standard length is 3000 mm.
- 2- Each cable tray needs 2 pcs straight connectors.
- 3- Each straight connector needs 4 sets of M8x15 nuts&bolts.
- 4- We use stainless steel material upon request.
- 5- Please indicate order code and the type of coating in your orders.
- 6- Different sheet thicknesses can be produced.

**H40 Ek Elemanı - Straight Connection Coupler H40**

SİPARİŞ KODU ORDER CODE	STOK KODU STOCK CODE	L mm	T mm	AĞIRLIK (KG/MT) WEIGHT (KG/MT)
A1-04-12-140 PG	01002A10412140PG	140	1.2	0.055
A1-04-15-140 PG	01002A10415140PG	140	1.5	0.070
A1-04-12-210 PG	01002A10412210PG	210	1.2	0.084
A1-04-15-210 PG	01002A10415210PG	210	1.5	0.105
A1-04-12-140 HDG	01002A10412140HDG	140	1.2	0.075
A1-04-15-140 HDG	01002A10415140HDG	140	1.5	0.100
A1-04-12-210 HDG	01002A10412210HDG	210	1.2	0.115
A1-04-15-210 HDG	01002A10415210HDG	210	1.5	0.150

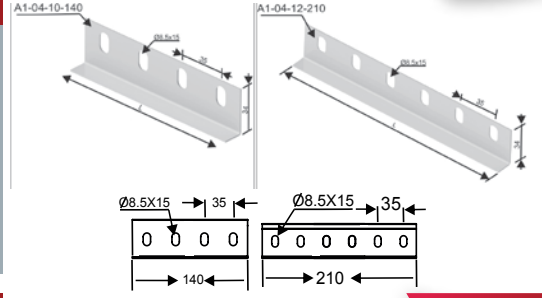
**YENİ ÜRÜN**  
NEW PRODUCT**H50 Ek Elemanı - Straight Connection Coupler H50**

SİPARİŞ KODU ORDER CODE	STOK KODU STOCK CODE	L mm	T mm	AĞIRLIK (KG/MT) WEIGHT (KG/MT)
A1-05-12-140 PG	01002A10512140PG	140	1.2	0.070
A1-05-15-140 PG	01002A10515140PG	140	1.5	0.090
A1-05-12-210 PG	01002A10512210PG	210	1.2	0.105
A1-05-15-210 PG	01002A10515210PG	210	1.5	0.135
A1-05-12-140 HDG	01002A10512140HDG	140	1.2	0.090
A1-05-15-140 HDG	01002A10515140HDG	140	1.5	0.120
A1-05-12-210 HDG	01002A10512210HDG	210	1.2	0.140
A1-05-15-210 HDG	01002A10515210HDG	210	1.5	0.185

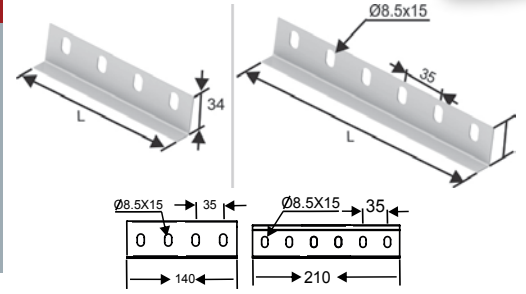
**YENİ ÜRÜN**  
NEW PRODUCT**H60 Ek Elemanı - Straight Connection Coupler H60**

SİPARİŞ KODU ORDER CODE	STOK KODU STOCK CODE	L mm	T mm	AĞIRLIK (KG/MT) WEIGHT (KG/MT)
A1-06-12-140 PG	01002A10612140PG	140	1.2	0.078
A1-06-15-140 PG	01002A10615140PG	140	1.5	0.100
A1-06-12-210 PG	01002A10612210PG	210	1.2	0.120
A1-06-15-210 PG	01002A10615210PG	210	1.5	0.150
A1-06-12-140 HDG	01002A10612140HDG	140	1.2	0.100
A1-06-15-140 HDG	01002A10615140HDG	140	1.5	0.135
A1-06-12-210 HDG	01002A10612210HDG	210	1.2	0.150
A1-06-15-210 HDG	01002A10615210HDG	210	1.5	0.200

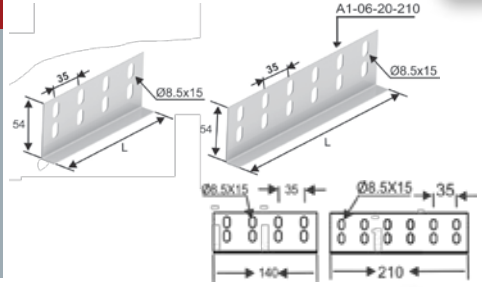
**YENİ ÜRÜN**  
NEW PRODUCT**H80 Ek Elemanı - Straight Connection Coupler H80**

SİPARİŞ KODU ORDER CODE	STOK KODU STOCK CODE	L mm	T mm	AĞIRLIK (KG/MT) WEIGHT (KG/MT)
A1-08-12-140 PG	01002A10812140PG	140	1.2	0.095
A1-08-15-140 PG	01002A10815140PG	140	1.5	0.125
A1-08-12-210 PG	01002A10812210PG	210	1.2	0.145
A1-08-15-210 PG	01002A10815210PG	210	1.5	0.185
A1-08-12-140 HDG	01002A10812140HDG	140	1.2	0.130
A1-08-15-140 HDG	01002A10815140HDG	140	1.5	0.170
A1-08-12-210 HDG	01002A10812210HDG	210	1.2	0.195
A1-08-15-210 HDG	01002A10815210HDG	210	1.5	0.255

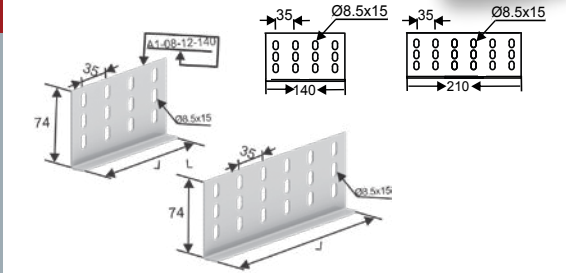
**YENİ ÜRÜN**  
NEW PRODUCT**H100 Ek Elemanı - Straight Connection Coupler H100**

SİPARİŞ KODU ORDER CODE	STOK KODU STOCK CODE	L mm	T mm	AĞIRLIK (KG/MT) WEIGHT (KG/MT)
A1-10-12-140 PG	01002A11012140PG	140	1.2	0.120
A1-10-15-140 PG	01002A11015140PG	140	1.5	0.150
A1-10-12-210 PG	01002A11012210PG	210	1.2	0.175
A1-10-15-210 PG	01002A11015210PG	210	1.5	0.225
A1-10-12-140 HDG	01002A11012140HDG	140	1.2	0.165
A1-10-15-140 HDG	01002A11015140HDG	140	1.5	0.220
A1-10-12-210 HDG	01002A11012210HDG	210	1.2	0.245
A1-10-15-210 HDG	01002A11015210HDG	210	1.5	0.325

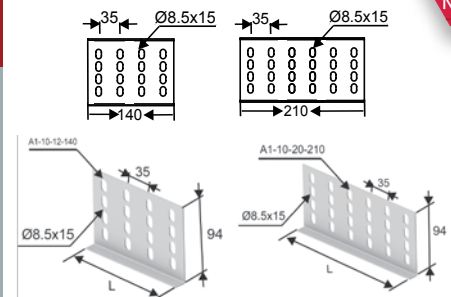
**YENİ ÜRÜN**  
NEW PRODUCT



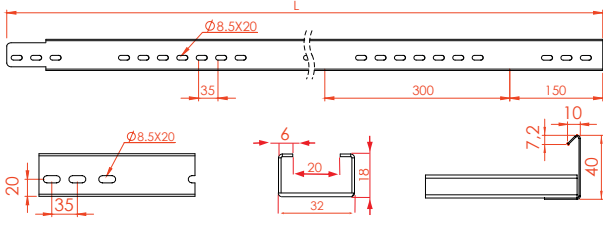

### M4 Serisi Kablo Merdivenleri - Cable Ladder M4 Series H40

SİPARİŞ KODU ORDER CODE	STOK KODU STOCK CODE	H mm	W mm	T mm	AĞIRLIK (KG/MT) WEIGHT (KG/MT) (PG to ISO 10346)
A 10-M4-10 PG	01008A10M410PG	40	100	1.0	1.100
A 20-M4-10 PG	01008A10M410PG	40	200	1.0	1.240
A 30-M4-10 PG	01008A30M410PG	40	300	1.0	1.380
A 40-M4-10 PG	01008A40M410PG	40	400	1.0	1.660
A 50-M4-10 PG	01008A50M410PG	40	500	1.0	1.830
A 60-M4-10 PG	01008A60M410PG	40	600	1.0	2.010
A 70-M4-20 PG	01008A70M420PG	40	700	2.0	3.110
A 80-M4-20 PG	01008A80M420PG	40	800	2.0	3.280
A 90-M4-20 PG	01008A90M420PG	40	900	2.0	3.450
A 100-M4-20 PG	01008A100M420PG	40	1000	2.0	3.630

1,0 - 1,2 - 1,5 - 2,0 mm Kalınlıkları mevcuttur  
1,0 - 1,2 - 1,5 - 2,0 Available in thicknesses

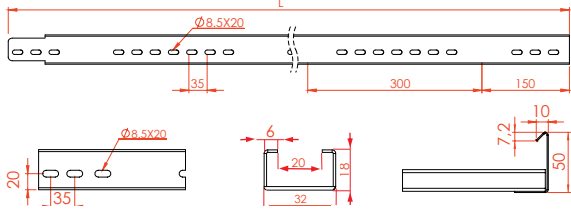

### M5 Serisi Kablo Merdivenleri - Cable Ladder M5 Series H50

SİPARİŞ KODU ORDER CODE	STOK KODU STOCK CODE	H mm	W mm	T mm	AĞIRLIK (KG/MT) WEIGHT (KG/MT) (PG to ISO 10346)
A 10-M5-10 PG	01008A10M510PG	50	100	1.0	1.240
A 20-M5-10 PG	01008A10M510PG	50	200	1.0	1.390
A 30-M5-10 PG	01008A30M510PG	50	300	1.0	1.520
A 40-M5-10 PG	01008A40M510PG	50	400	1.0	1.800
A 50-M5-10 PG	01008A50M5-10PG	50	500	1.0	1.970
A 60-M5-10 PG	01008A60M510PG	50	600	1.0	2.150
A 70-M5-20 PG	01008A70M520PG	50	700	2.0	3.370
A 80-M5-20 PG	01008A80M520PG	50	800	2.0	3.540
A 90-M5-20 PG	01008A90M520PG	50	900	2.0	3.710
A 100-M5-20 PG	01008A100M520PG	50	1000	2.0	3.890

1,0 - 1,2 - 1,5 - 2,0 mm Kalınlıkları mevcuttur  
1,0 - 1,2 - 1,5 - 2,0 Available in thicknesses

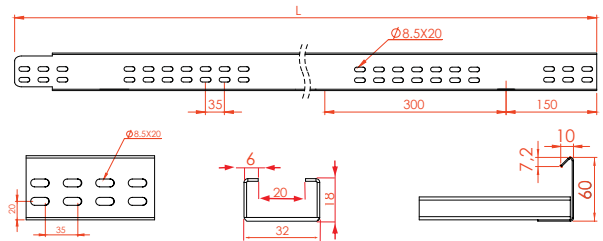

### M6 Serisi Kablo Merdivenleri - Cable Ladder M6 Series H60

SİPARİŞ KODU ORDER CODE	STOK KODU STOCK CODE	H mm	W mm	T mm	AĞIRLIK (KG/MT) WEIGHT (KG/MT) (PG to ISO 10346)
A 10-M6-10 PG	01008A10M610PG	60	100	1.0	1.330
A 20-M6-10 PG	01008A10M610PG	60	200	1.0	1.480
A 30-M6-10 PG	01008A30M610PG	60	300	1.0	1.610
A 40-M6-10 PG	01008A40M610PG	60	400	1.0	1.890
A 50-M6-10 PG	01008A50M610PG	60	500	1.0	2.060
A 60-M6-10 PG	01008A60M610PG	60	600	1.0	2.240

**M7 Serisi Kablo Merdivenleri - Cable Ladder M7 Series H70**

SİPARİŞ KODU ORDER CODE	STOK KODU STOCK CODE	H mm	W mm	T mm	AĞIRLIK (KG/MT) WEIGHT (KG/MT) (PG to ISO 10346)
A 10-M7-10 PG	01008A10M710PG	70	100	1.0	1.470
A 20-M7-10 PG	01008A10M710PG	70	200	1.0	1.620
A 30-M7-10 PG	01008A30M710PG	70	300	1.0	1.750
A 40-M7-10 PG	01008A40M710PG	70	400	1.0	2.030
A 50-M7-10 PG	01008A50M710PG	70	500	1.0	2.200
A 60-M7-10 PG	01008A60M710PG	70	600	1.0	2.380

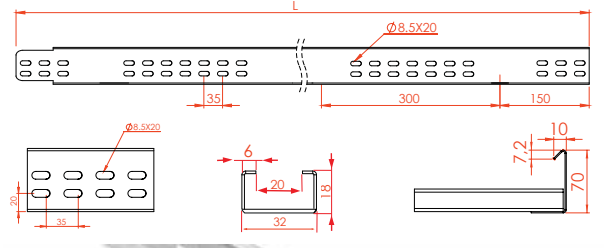
**M10 Serisi Kablo Merdivenleri - Cable Ladder M10 Series H100**

SİPARİŞ KODU ORDER CODE	STOK KODU STOCK CODE	H mm	W mm	T mm	AĞIRLIK (KG/MT) WEIGHT (KG/MT) (PG to ISO 10346)
A 10-M10-10 PG	01008A10M1010PG	100	100	1.0	1.800
A 20-M10-10 PG	01008A10M1010PG	100	200	1.0	1.940
A 30-M10-10 PG	01008A30M1010PG	100	300	1.0	2.070
A 40-M10-10 PG	01008A40M1010PG	100	400	1.0	2.360
A 50-M10-10 PG	01008A50M1010PG	100	500	1.0	2.520
A 60-M10-10 PG	01008A60M1010PG	100	600	1.0	2.710

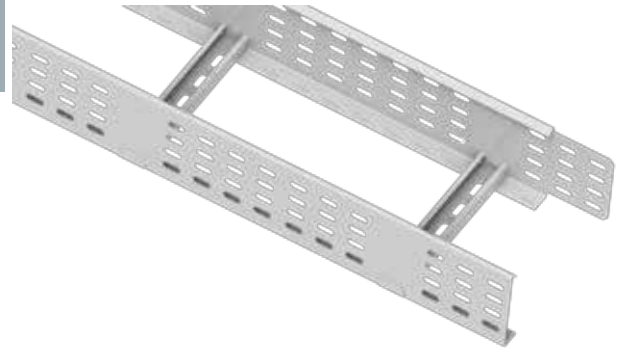
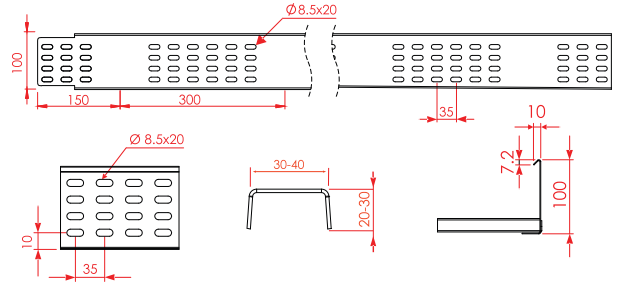
**U Serisi Kablo Merdivenleri - Cable Ladder U Series H40**

SİPARİŞ KODU ORDER CODE	STOK KODU STOCK CODE	H mm	W mm	T mm	AĞIRLIK (KG/MT) WEIGHT (KG/MT) (HDG TS EN ISO 1461)
A 10-M4-4015-U HDG	01008A10M44015UHDG	40	100	1.5	1,930
A 20-M4-4015-U HDG	01008A20M44015UHDG	40	200	1.5	2,115
A 30-M4-4015-U HDG	01008A30M44015UHDG	40	300	1.5	2,295
A 40-M4-4015-U HDG	01008A40M44015UHDG	40	400	1.5	2,480
A 50-M4-4015-U HDG	01008A50M44015UHDG	40	500	1.5	2,670
A 60-M4-4012-U HDG	01008A60M44012UHDG	40	600	1.2	2,520
A 60-M4-4020-U HDG	01008A60M44020UHDG	40	600	2.0	3,440
A 70-M4-4020-U HDG	01008A70M44020UHDG	40	700	2.0	3,625
A 80-M4-4020-U HDG	01008A80M44020UHDG	40	800	2.0	3,805
A 90-M4-400-U HDG	01008A90M44020UHDG	40	900	2.0	3,995
A 100-M4-4020-U HDG	01008A100M44020UHDG	40	1000	2.0	4,190

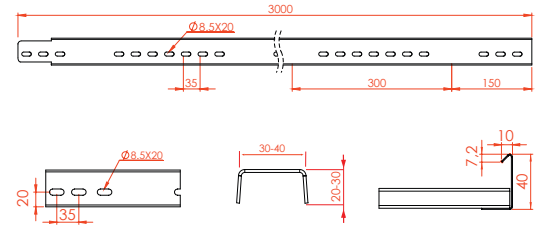

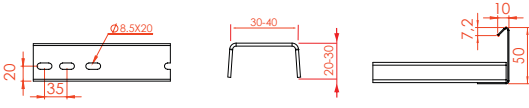
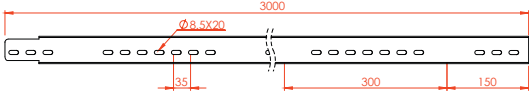

### U Serisi Kablo Merdivenleri - Cable Ladder U Series **H50**

SİPARİŞ KODU ORDER CODE	STOK KODU STOCK CODE	H mm	W mm	T mm	AĞIRLIK (KG/MT) WEIGHT (KG/MT) (HDG TS EN ISO 1461)
A 10-M5-5015-U HDG	01008A10M55015UHDG	50	100	1.5	2,195
A 20-M5-5015-U HDG	01008A20M55015UHDG	50	200	1.5	2,380
A 30-M5-5015-U HDG	01008A30M55015UHDG	50	300	1.5	2,560
A 40-M5-5015-U HDG	01008A40M55015UHDG	50	400	1.5	2,745
A 50-M5-5015-U HDG	01008A50M55015UHDG	50	500	1.5	2,935
A 60-M5-5015-U HDG	01008A60M55015UHDG	50	600	1.5	3,130
A 70-M5-5020-U HDG	01008A70M55020UHDG	50	700	2.0	3,975
A 80-M5-5020-U HDG	01008A80M55020UHDG	50	800	2.0	4,160
A 90-M5-5020-U HDG	01008A90M55020UHDG	50	900	2.0	4,350
A 100-M5-5020-U HDG	01008A100M55020UHDG	50	1000	2.0	4,540

### U Serisi Kablo Merdivenleri - Cable Ladder U Series **H60**

SİPARİŞ KODU ORDER CODE	STOK KODU STOCK CODE	H mm	W mm	T mm	AĞIRLIK (KG/MT) WEIGHT (KG/MT) (HDG TS EN ISO 1461)
A 10-M6-6015-U HDG	01008A10M66015UHDG	60	100	1.5	2,375
A 20-M6-6015-U HDG	01008A20M66015UHDG	60	200	1.5	2,560
A 30-M6-6015-U HDG	01008A30M66015UHDG	60	300	1.5	2,740
A 40-M6-6015-U HDG	01008A40M66015UHDG	60	400	1.5	2,925
A 50-M6-6015-U HDG	01008A50M66015UHDG	60	500	1.5	3,115
A 60-M6-6015-U HDG	01008A60M66015UHDG	60	600	1.5	3,310
A 70-M6-6020-U HDG	01008A70M66020UHDG	60	700	2.0	4,215
A 80-M6-6020-U HDG	01008A80M66020UHDG	60	800	2.0	4,400
A 90-M6-6020-U HDG	01008A90M66020UHDG	60	900	2.0	4,590
A 100-M6-6020-U HDG	01008A100M66020UHDG	60	1000	2.0	4,785

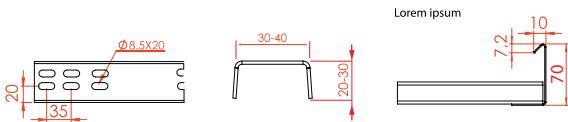
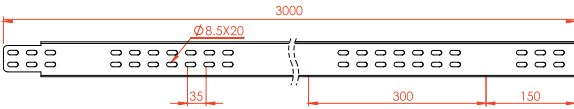
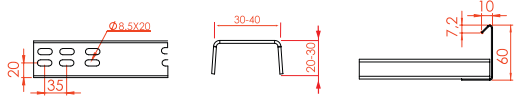
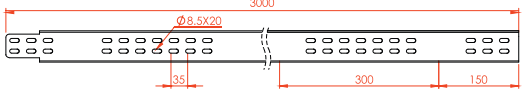

### U Serisi Kablo Merdivenleri - Cable Ladder U Series **H70**

SİPARİŞ KODU ORDER CODE	STOK KODU STOCK CODE	H mm	W mm	T mm	AĞIRLIK (KG/MT) WEIGHT (KG/MT) (HDG TS EN ISO 1461)
A 10-M7-7015-U HDG	01008A10M77015UHDG	70	100	1.5	2,635
A 20-M7-7015-U HDG	01008A20M77015UHDG	70	200	1.5	2,820
A 30-M7-7015-U HDG	01008A30M77015UHDG	70	300	1.5	3,000
A 40-M7-7015-U HDG	01008A40M77015UHDG	70	400	1.5	3,185
A 50-M7-7015-U HDG	01008A50M77015UHDG	70	500	1.5	3,375
A 60-M7-7015-U HDG	01008A60M77015UHDG	70	600	1.5	3,570
A 70-M7-7020-U HDG	01008A70M77020UHDG	70	700	2.0	4,560
A 80-M7-7020-U HDG	01008A80M77020UHDG	70	800	2.0	4,745
A 90-M7-7020-U HDG	01008A90M77020UHDG	70	900	2.0	4,935
A 100-M7-7020-U HDG	01008A100M77020UHDG	70	1000	2.0	5,130

**U Serisi Kablo Merdivenleri - Cable Ladder U Series H100**

SİPARİŞ KODU ORDER CODE	STOK KODU STOCK CODE	H mm	W mm	T mm	AĞIRLIK (KG/MT) WEIGHT (KG/MT) (HDG TS EN ISO 1461)
A 10-M10-10015-U HDG	01008A10M1010015UHDG	100	100	1.5	3.255
A 20-M10-10015-U HDG	01008A20M1010015UHDG	100	200	1.5	3.440
A 30-M10-10015-U HDG	01008A30M1010015UHDG	100	300	1.5	3.620
A 40-M10-10015-U HDG	01008A40M1010015UHDG	100	400	1.5	3.805
A 50-M10-10015-U HDG	01008A50M1010015UHDG	100	500	1.5	3.995
A 60-M10-10015-U HDG	01008A60M1010015UHDG	100	600	1.5	4.190
A 70-M10-10020-U HDG	01008A70M1010020UHDG	100	700	2.0	5.390
A 80-M10-10020-U HDG	01008A80M1010020UHDG	100	800	2.0	5.575
A 90-M10-10020-U HDG	01008A90M1010020UHDG	100	900	2.0	5.765
A 100-M10-10020-U HDG	01008A100M1010020UHDG	100	1000	2.0	5.955

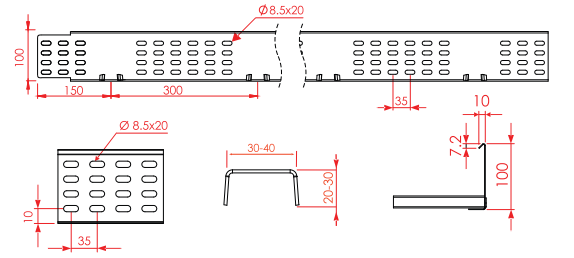

**H35**

SİPARİŞ KODU ORDER CODE	STOK KODU STOCK CODE	H mm	W mm	T mm	AĞIRLIK (KG/MT) WEIGHT (KG/MT) (E.G to TS EN 149:2005)
ATK-05-04 EG	01006ATK0504EG	35	50	4.0	0.760
ATK-10-04 EG	01006ATK1004EG	35	100	4.0	1.080
ATK-15-04 EG	01006ATK1504EG	35	150	4.0	1.330
ATK-20-04 EG	01006ATK2004EG	35	200	4.0	1.580
ATK-25-04 EG	01006ATK2504EG	35	250	4.0	1.830
ATK-30-04 EG	01006ATK3004EG	35	300	4.0	2.090
ATK-35-04 EG	01006ATK3504EG	35	350	4.0	2.440
ATK-40-04 EG	01006ATK4004EG	35	400	4.0	2.590
ATK-45-04 EG	01006ATK4504EG	35	450	4.0	2.840
ATK-50-04 EG	01006ATK5004EG	35	500	4.0	3.090
ATK-55-04 EG	01006ATK5504EG	35	550	4.0	3.440
ATK-60-04 EG	01006ATK6004EG	35	600	4.0	3.600

5 mm Kalınlıkları mevcuttur  
5 Available in thicknesses

**H35**

SİPARİŞ KODU ORDER CODE	STOK KODU STOCK CODE	H mm	W mm	T mm	AĞIRLIK (KG/MT) WEIGHT (KG/MT) (HDG to TS EN ISO 1461)
ATK-05-04 HDG	01006ATK0504HDG	35	50	4.0	0.840
ATK-10-04 HDG	01006ATK1004HDG	35	100	4.0	1.190
ATK-15-04 HDG	01006ATK1504HDG	35	150	4.0	1.465
ATK-20-04 HDG	01006ATK2004HDG	35	200	4.0	1.740
ATK-25-04 HDG	01006ATK2504HDG	35	250	4.0	2.015
ATK-30-04 HDG	01006ATK3004HDG	35	300	4.0	2.300
ATK-35-04 HDG	01006ATK3504HDG	35	350	4.0	2.575
ATK-40-04 HDG	01006ATK4004HDG	35	400	4.0	2.850
ATK-45-04 HDG	01006ATK4504HDG	35	450	4.0	3.125
ATK-50-04 HDG	01006ATK5004HDG	35	500	4.0	3.400
ATK-55-04 HDG	01006ATK5504HDG	35	550	4.0	3.675
ATK-60-04 HDG	01006ATK6004HDG	35	600	4.0	3.960

5 mm Kalınlıkları mevcuttur  
5 Available in thicknesses

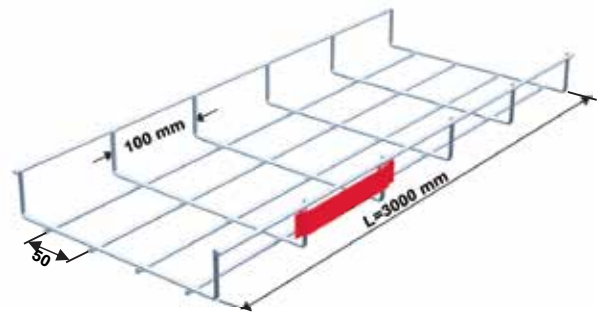
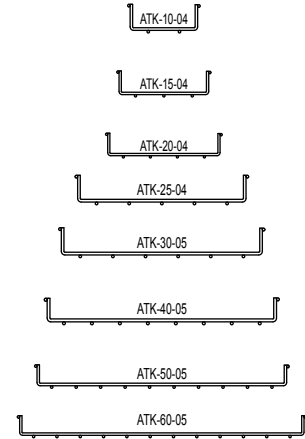
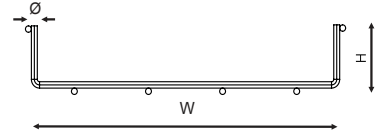

YENİ ÜRÜN  
NEW PRODUCT

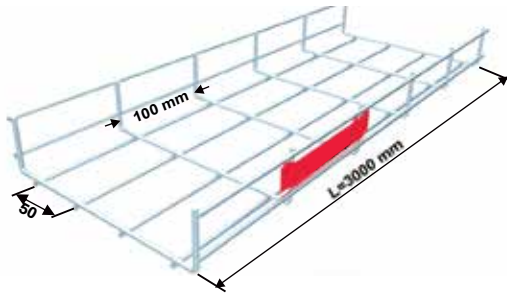
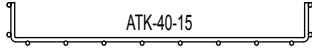
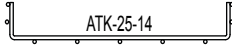
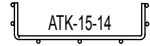
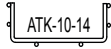
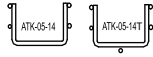
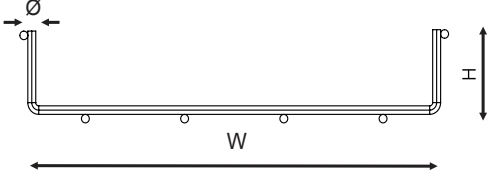

## H55

SİPARİŞ KODU ORDER CODE	STOK KODU STOCK CODE	H mm	W mm	T mm	AĞIRLIK (KG/MT) WEIGHT (KG/MT) (E.G to TS EN 149:2005)
ATK-05-14 EG	01006ATK0514EG	55	50	4.0	0.855
ATK-10-14 EG	01006ATK1014EG	55	100	4.0	1.170
ATK-15-14 EG	01006ATK1514EG	55	150	4.0	1.420
ATK-20-14 EG	01006ATK2014EG	55	200	4.0	1.680
ATK-25-14 EG	01006ATK2514EG	55	250	4.0	1.930
ATK-30-14 EG	01006ATK3014EG	55	300	4.0	2.180
ATK-35-14 EG	01006ATK3514EG	55	350	4.0	2.430
ATK-40-14 EG	01006ATK4014EG	55	400	4.0	2.680
ATK-45-14 EG	01006ATK4514EG	55	450	4.0	2.930
ATK-50-14 EG	01006ATK5014EG	55	500	4.0	3.180
ATK-55-14 EG	01006ATK5514EG	55	550	4.0	3.440
ATK-60-14 EG	01006ATK6014EG	55	600	4.0	3.690

## H55

SİPARİŞ KODU ORDER CODE	STOK KODU STOCK CODE	H mm	W mm	T mm	AĞIRLIK (KG/MT) WEIGHT (KG/MT) (HDG to TS EN ISO 1461)
ATK-05-14 HDG	01006ATK0514HDG	55	50	4.0	0.950
ATK-10-14 HDG	01006ATK1014HDG	55	100	4.0	1.290
ATK-15-14 HDG	01006ATK1514HDG	55	150	4.0	1.565
ATK-20-14 HDG	01006ATK2014HDG	55	200	4.0	1.850
ATK-25-14 HDG	01006ATK2514HDG	55	250	4.0	2.125
ATK-30-14 HDG	01006ATK3014HDG	55	300	4.0	2.400
ATK-35-14 HDG	01006ATK3514HDG	55	350	4.0	2.675
ATK-40-14 HDG	01006ATK4014HDG	55	400	4.0	2.950
ATK-45-14 HDG	01006ATK4514HDG	55	450	4.0	3.225
ATK-50-14 HDG	01006ATK5014HDG	55	500	4.0	3.500
ATK-55-14 HDG	01006ATK5514HDG	55	550	4.0	3.785
ATK-60-14 HDG	01006ATK6014HDG	55	600	4.0	4.060

## H75

SİPARİŞ KODU ORDER CODE	STOK KODU STOCK CODE	H mm	W mm	T mm	AĞIRLIK (KG/MT) WEIGHT (KG/MT) (E.G to TS EN 149:2005)
ATK-10-44 EG	01006ATK1044EG	75	100	4.0	1.250
ATK-15-44 EG	01006ATK1544EG	75	150	4.0	1.500
ATK-20-44 EG	01006ATK2044EG	75	200	4.0	1.750
ATK-25-44 EG	01006ATK2544EG	75	250	4.0	2.000
ATK-30-44 EG	01006ATK3044EG	75	300	4.0	2.250
ATK-35-44 EG	01006ATK3544EG	75	350	4.0	2.510
ATK-40-44 EG	01006ATK4044EG	75	400	4.0	2.760
ATK-45-44 EG	01006ATK4544EG	75	450	4.0	3.010
ATK-50-44 EG	01006ATK5044EG	75	500	4.0	3.260
ATK-55-44 EG	01006ATK5544EG	75	550	4.0	3.510
ATK-60-44 EG	01006ATK6044EG	75	600	4.0	3.760

5 mm Kalınlıkları mevcuttur - 5 Available in thicknesses



## H75

SİPARİŞ KODU ORDER CODE	STOK KODU STOCK CODE	H mm	W mm	T mm	AĞIRLIK (KG/MT) WEIGHT (KG/MT) (HDG to TS EN ISO 1461)
ATK-10-44 HDG	01006ATK1044HDG	75	100	4.0	1.375
ATK-15-44 HDG	01006ATK1544HDG	75	150	4.0	1.650
ATK-20-44 HDG	01006ATK2044HDG	75	200	4.0	1.925
ATK-25-44 HDG	01006ATK2544HDG	75	250	4.0	2.200
ATK-30-44 HDG	01006ATK3044HDG	75	300	4.0	2.475
ATK-35-44 HDG	01006ATK3544HDG	75	350	4.0	2.765
ATK-40-44 HDG	01006ATK4044HDG	75	400	4.0	3.040
ATK-45-44 HDG	01006ATK4544HDG	75	450	4.0	3.315
ATK-50-44 HDG	01006ATK5044HDG	75	500	4.0	3.590
ATK-55-44 HDG	01006ATK5544HDG	75	550	4.0	3.865
ATK-60-44 HDG	01006ATK6044HDG	75	600	4.0	4.140

5 mm Kalınlıkları mevcuttur - 5 Available in thicknesses

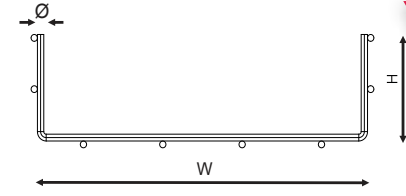
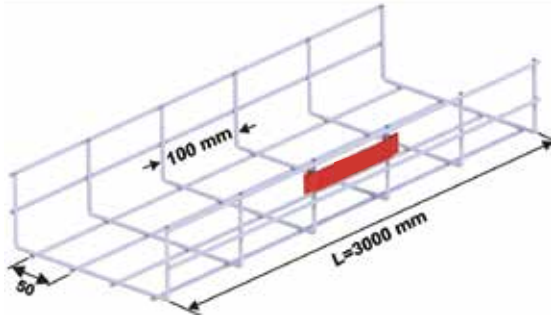
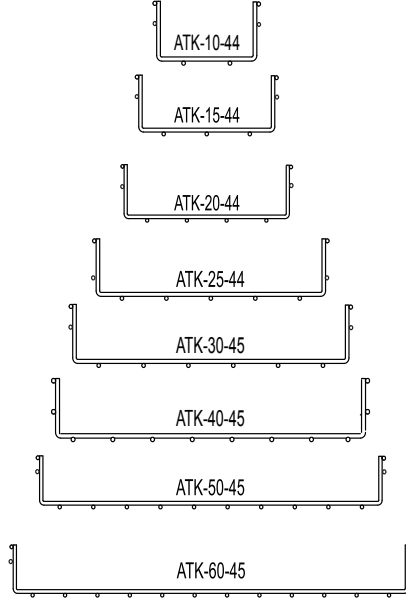
YENİ ÜRÜN  
NEW PRODUCT

## H100

SİPARİŞ KODU ORDER CODE	STOK KODU STOCK CODE	H mm	W mm	T mm	AĞIRLIK (KG/MT) WEIGHT (KG/MT) (E.G to TS EN 149:2005)
ATK-10-24 EG	01006ATK1024EG	100	100	4.0	1.520
ATK-15-24 EG	01006ATK1524EG	100	150	4.0	1.770
ATK-20-24 EG	01006ATK2024EG	100	200	4.0	2.030
ATK-25-24 EG	01006ATK2524EG	100	250	4.0	2.280
ATK-30-24 EG	01006ATK3024EG	100	300	4.0	2.530
ATK-35-24 EG	01006ATK3524EG	100	350	4.0	2.780
ATK-40-24 EG	01006ATK4024EG	100	400	4.0	3.030
ATK-45-24 EG	01006ATK4524EG	100	450	4.0	3.280
ATK-50-24 EG	01006ATK5024EG	100	500	4.0	3.530
ATK-55-24 EG	01006ATK5524EG	100	550	4.0	3.790
ATK-60-24 EG	01006ATK6024EG	100	600	4.0	4.040

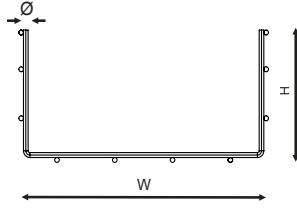
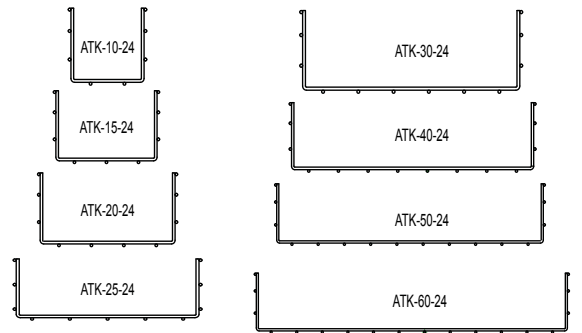
YENİ ÜRÜN  
NEW PRODUCT

## H100

SİPARİŞ KODU ORDER CODE	STOK KODU STOCK CODE	H mm	W mm	T mm	AĞIRLIK (KG/MT) WEIGHT (KG/MT) (HDG to TS EN ISO 1461)
ATK-10-24 HDG	01006ATK1024HDG	100	100	4.0	1.675
ATK-15-24 HDG	01006ATK1524HDG	100	150	4.0	1.950
ATK-20-24 HDG	01006ATK2024HDG	100	200	4.0	2.245
ATK-25-24 HDG	01006ATK2524HDG	100	250	4.0	2.510
ATK-30-24 HDG	01006ATK3024HDG	100	300	4.0	2.785
ATK-35-24 HDG	01006ATK3524HDG	100	350	4.0	3.060
ATK-40-24 HDG	01006ATK4024HDG	100	400	4.0	3.445
ATK-45-24 HDG	01006ATK4524HDG	100	450	4.0	3.610
ATK-50-24 HDG	01006ATK5024HDG	100	500	4.0	3.885
ATK-55-24 HDG	01006ATK5524HDG	100	550	4.0	4.170
ATK-60-24 HDG	01006ATK6024HDG	100	600	4.0	4.445

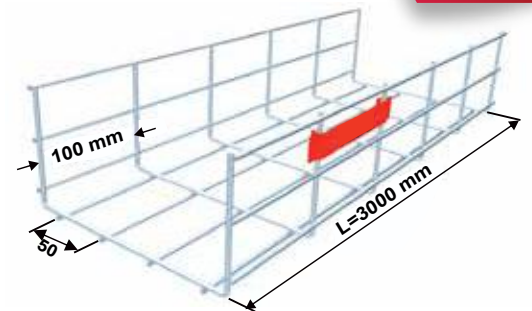
YENİ ÜRÜN  
NEW PRODUCT

**YENİ ÜRÜN**  
NEW PRODUCT

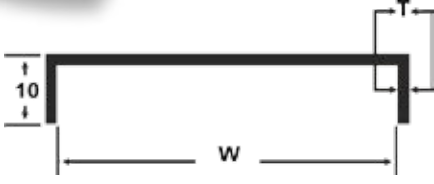

Standart Length = 1500 mm (H.D.G.)  
Standart Length = 1500 mm (P.G.)

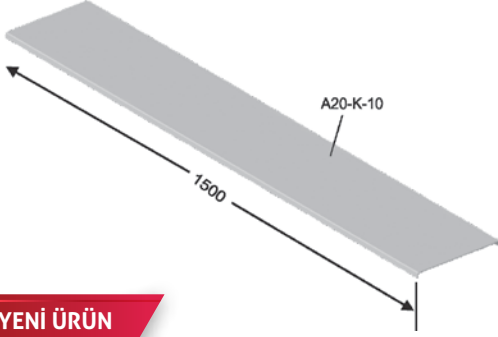

**YENİ ÜRÜN**  
NEW PRODUCT

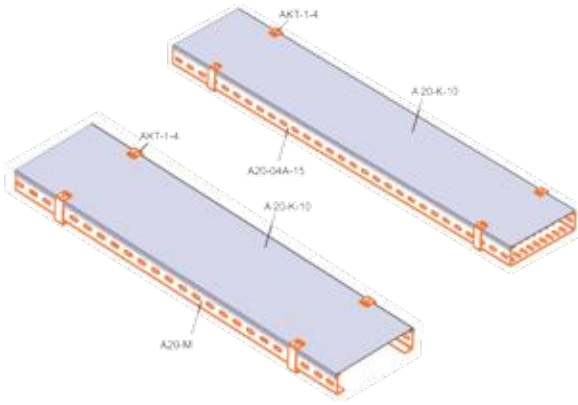

**Bağlantı Örneği**  
Connection Example

### H10

SİPARİŞ KODU ORDER CODE	STOK KODU STOCK CODE	H mm	W mm	T mm	AĞIRLIK (KG/MT) WEIGHT (KG/MT)
A-05-K-10 PG	01010A05K10PG	10	50	1.0	0.490
A-10-K-10 PG	01010A10K10PG	10	100	1.0	0.850
A-12-K-10 PG	01010A12K10PG	10	120	1.0	0.990
A-16-K-10 PG	01010A16K10PG	10	160	1.0	1.270
A-20-K-10 PG	01010A20K10PG	10	200	1.0	1.550
A-25-K-10 PG	01010A25K10PG	10	250	1.0	1.910
A-30-K-10 PG	01010A30K10PG	10	300	1.0	2.260
A-40-K-10 PG	01010A40K10PG	10	400	1.0	2.970
A-45-K-10 PG	01010A45K10PG	10	450	1.0	3.320
A-50-K-10 PG	01010A50K10PG	10	500	1.0	3.670
A-60-K-10 PG	01010A60K10PG	10	600	1.0	4.380
A-70-K-12 PG	01010A70K12PG	10	700	1.2	6.220
A-80-K-12 PG	01010A80K12PG	10	800	1.2	7.080
A-90-K-15 PG	01010A90K15PG	10	900	1.5	10.110
A-100-K-15 PG	01010A100K15PG	10	1000	1.5	11.210

1,2 - 1,5 - 2,0 mm Kalınlıkları mevcuttur - 1,2 - 1,5 - 2,0 Available in thicknesses

### H10

SİPARİŞ KODU ORDER CODE	STOK KODU STOCK CODE	H mm	W mm	T mm	AĞIRLIK (KG/MT) WEIGHT (KG/MT)
A-05-K-10 HDG	01010A05K10HDG	10	50	1.0	0.530
A-10-K-10 HDG	01010A10K10HDG	10	100	1.0	0.880
A-12-K-10 HDG	01010A12K10HDG	10	120	1.0	1.020
A-16-K-10 HDG	01010A16K10HDG	10	160	1.0	1.310
A-20-K-10 HDG	01010A20K10HDG	10	200	1.0	1.590
A-25-K-10 HDG	01010A25K10HDG	10	250	1.0	1.940
A-30-K-10 HDG	01010A30K10HDG	10	300	1.0	2.300
A-40-K-10 HDG	01010A40K10HDG	10	400	1.0	3.000
A-45-K-10 HDG	01010A45K10HDG	10	450	1.0	3.360
A-50-K-10 HDG	01010A50K10HDG	10	500	1.0	3.710
A-60-K-10 HDG	01010A60K10HDG	10	600	1.0	4.420
A-70-K-12 HDG	01010A70K12HDG	10	700	1.2	6.260
A-80-K-12 HDG	01010A80K12HDG	10	800	1.2	7.120
A-90-K-15 HDG	01010A90K15HDG	10	900	1.5	9.800
A-100-K-15 HDG	01010A100K15HDG	10	1000	1.5	10.860

**Merdiven ve kanal kapakları siparişe göre farklı ölçülerde ve kalınlıklarda üretilebilir.**

Ladder & Tray Covers can be manufactured in different dimensions and thickness.

## Vidasız Kapak Tutucuları - Cover Clamp Without Screw

40 - 50 - 60 - 70 - 80 - 90 - 100

YENİ ÜRÜN  
NEW PRODUCT

SİPARİŞ KODU ORDER CODE	STOK KODU STOCK CODE	H mm	T mm	AĞIRLIK (KG/MT) WEIGHT (KG/MT)
AKT-1-04 PG	01010AKT104PG	40	2.0	0.028
AKT-1-05 PG	01010AKT105PG	50	2.0	0.030
AKT-1-06 PG	01010AKT106PG	60	2.0	0.032
AKT-1-07 PG	01010AKT107PG	70	2.0	0.034
AKT-1-08 PG	01010AKT108PG	80	2.0	0.035
AKT-1-10 PG	01010AKT110PG	100	2.0	0.050
AKT-1-12 PG	01010AKT112PG	125	2.0	0.065
AKT-1-15 PG	01010AKT115PG	150	2.0	0.080

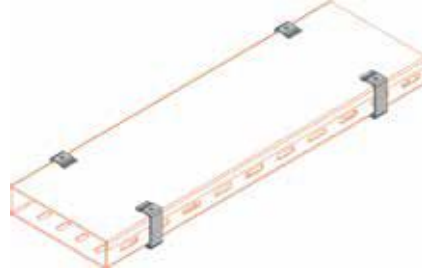
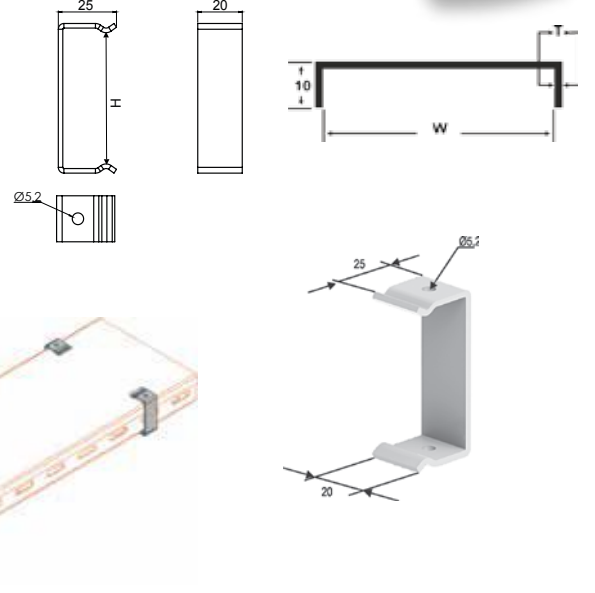

## Deliksiz C Profiller - C Profiles (Without Slot)

SİPARİŞ KODU ORDER CODE	STOK KODU STOCK CODE	L mm	T mm	AĞIRLIK (KG/MT) WEIGHT (KG/MT)
AC-41-21-15 PG	01011AC412115PG	3000	1.5	1.170
AC-41-21-20 PG	01011AC412120PG	3000	2.0	1.555
AC-41-21-25 PG	01011AC412125PG	3000	2.5	1.945
AC-41-21-15 HDG	01011AC412115HDG	3000	1.5	1.285
AC-41-21-20 HDG	01011AC412120HDG	3000	2.0	1.710
AC-41-21-25 HDG	01011AC412125HDG	3000	2.5	2.140

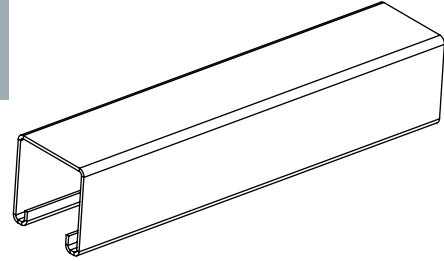
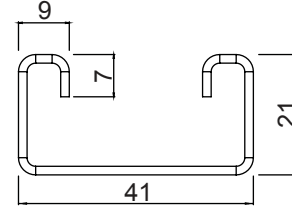

AC-41-21-15

## Deliksiz C Profiller - C Profiles (Without Slot)

SİPARİŞ KODU ORDER CODE	STOK KODU STOCK CODE	L mm	T mm	AĞIRLIK (KG/MT) WEIGHT (KG/MT)
ACD-41-21-15-13-1 PG	01011ACD412115131PG	3000	1.5	1.100
ACD-41-21-20-13-1 PG	01011ACD412120131PG	3000	2.0	1.465
ACD-41-21-25-13-1 PG	01011ACD412125131PG	3000	2.5	1.830
ACD-41-21-15-13-1 HDG	01011ACD412115131HDG	3000	1.5	1.210
ACD-41-21-20-13-1 HDG	01011ACD412120131HDG	3000	2.0	1.610
ACD-41-21-25-13-1 HDG	01011ACD412125131HDG	3000	2.5	2.015

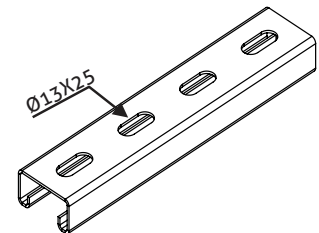
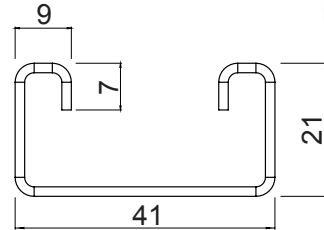

AC-41-21-15

YENİ ÜRÜN  
NEW PRODUCT

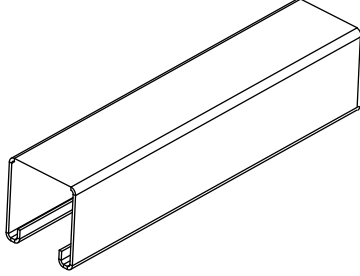
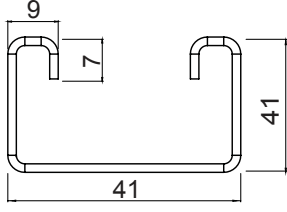

AC-41-41-15

### Deliksiz C Profiller - C Profiles (Without Slot)

SİPARİŞ KODU ORDER CODE	STOK KODU STOCK CODE	L mm	T mm	AĞIRLIK (KG/MT) WEIGHT (KG/MT)
AC-41-21-15 PG	01011AC414115PG	3000	1.5	1.625
AC-41-21-20 PG	01011AC414120PG	3000	2.0	2.170
AC-41-21-25 PG	01011AC414125PG	3000	2.5	2.710
AC-41-21-15 HDG	01011AC414115HDG	3000	1.5	1.790
AC-41-21-20 HDG	01011AC414120HDG	3000	2.0	2.385
AC-41-21-25 HDG	01011AC414125HDG	3000	2.5	2.980

YENİ ÜRÜN  
NEW PRODUCT

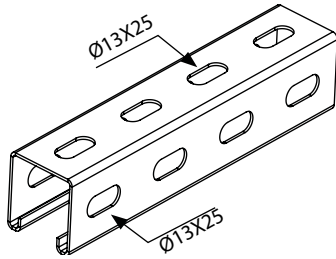
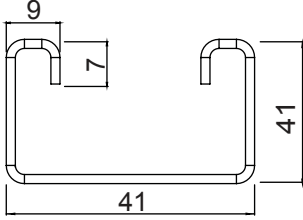

ACD-41-41-15-13-3

### 3 Yön Delikli C Profiller - C Profiles (With Slot 3 Side)

SİPARİŞ KODU ORDER CODE	STOK KODU STOCK CODE	L mm	T mm	AĞIRLIK (KG/MT) WEIGHT (KG/MT)
ACD-41-41-15-13-3 PG	01011AC41411513PG	3000	1.5	1.450
ACD-41-41-20-13-3 PG	01011AC41412013PG	3000	2.0	1.925
ACD-41-41-25-13-3 PG	01011AC41412513PG	3000	2.5	2.415
ACD-41-41-15-13-3 HDG	01011AC41411513HDG	3000	1.5	1.590
ACD-41-41-20-13-3 HDG	01011AC41412013HDG	3000	2.0	2.115
ACD-41-41-25-13-3 HDG	01011AC41412513HDG	3000	2.5	2.660

YENİ ÜRÜN  
NEW PRODUCT

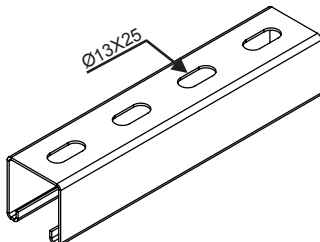
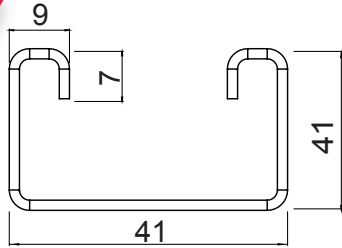

AC-41-41-15-13-1

### Tek Yön Delikli C Profiller - C Profiles (With Slot 1 Side)

SİPARİŞ KODU ORDER CODE	STOK KODU STOCK CODE	L mm	T mm	AĞIRLIK (KG/MT) WEIGHT (KG/MT)
ACD-41-41-15-13-1 PG	01011AC41411511PG	3000	1.5	1.420
ACD-41-41-20-13-1 PG	01011AC41412011PG	3000	2.0	1.895
ACD-41-41-25-13-1 PG	01011AC41412511PG	3000	2.5	2.370
ACD-41-41-15-13-1 HDG	01011AC41411511HDG	3000	1.5	1.590
ACD-41-41-20-13-1 HDG	01011AC41412011HDG	3000	2.0	2.085
ACD-41-41-25-13-1 HDG	01011AC41412511HDG	3000	2.5	2.605

## Kaynaklı Duvar Konsolları - Support For Wall Mounting (Welded)

110 - 150

YENİ ÜRÜN  
NEW PRODUCT

SİPARİŞ KODU ORDER CODE	STOK KODU STOCK CODE	H mm	W mm	T mm	AĞIRLIK (KG/MT) WEIGHT (KG/MT)
A6-10K EG	01006A610K080EG	80	110	1.5	0.210
A6-20K EG	01006A620K080EG	80	210	1.5	0.305
A6-30K EG	01006A630K110EG	110	310	1.5	0.505
A6-40K EG	01006A640K110EG	110	410	2.0	0.705
A6-50K EG	01006A650K110EG	110	510	2.0	0.840
A6-60K EG	01006A660K110EG	110	610	2.0	0.970
A6-10K HDG	01006A610K080HDG	80	110	1.5	0.220
A6-20K HDG	01006A620K080HDG	80	210	1.5	0.320
A6-30K HDG	01006A630K110HDG	110	310	1.5	0.530
A6-40K HDG	01006A640K110HDG	110	410	2.0	0.740
A6-50K HDG	01006A650K110HDG	110	510	2.0	0.880
A6-60K HDG	01006A660K110HDG	110	610	2.0	1,015

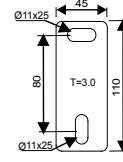
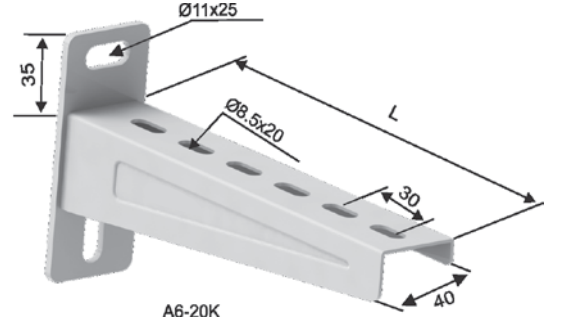
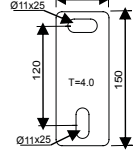
A6-10K/20K  
Taban Delik Detay  
Base Hole DetailA6-30K/60K  
Taban Delik Detay  
Base Hole Detail

## Kaynaksız Duvar Konsolları - Support For Wall Mounting

60 - 90 - 110 - 130 - 160 - 170 - 210

YENİ ÜRÜN  
NEW PRODUCT

SİPARİŞ KODU ORDER CODE	STOK KODU STOCK CODE	L mm	T mm	AĞIRLIK (KG/MT) WEIGHT (KG/MT)
A6-05 PG	01011A605PG	60	1.5	0.065
A6-08 PG	01011A608PG	90	1.5	0.095
A6-10 PG	01011A610PG	110	1.5	0.160
A6-12 PG	01011A612PG	130	1.5	0.160
A6-15 PG	01011A615PG	160	1.5	0.160
A6-16 PG	01011A616PG	170	1.5	0.175
A6-20 PG	01011A620PG	210	1.5	0.240
A6-05 HDG	01011A605HDG	60	1.5	0.075
A6-08 HDG	01011A608HDG	90	1.5	0.105
A6-10 HDG	01011A610HDG	110	1.5	0.180
A6-12 HDG	01011A612HDG	130	1.5	0.180
A6-15 HDG	01011A615HDG	160	1.5	0.190
A6-16 HDG	01011A616HDG	170	1.5	0.200
A6-20 HDG	01011A620HDG	210	1.5	0.275

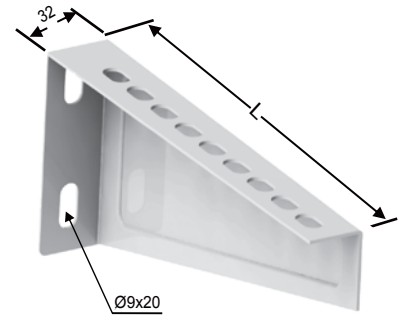
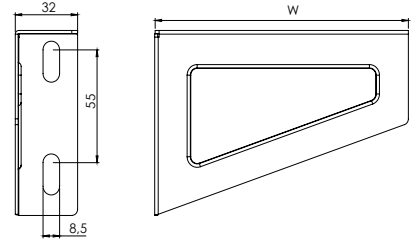



YENİ ÜRÜN  
NEW PRODUCT

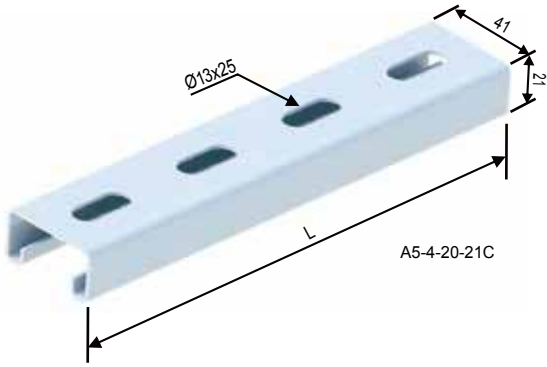
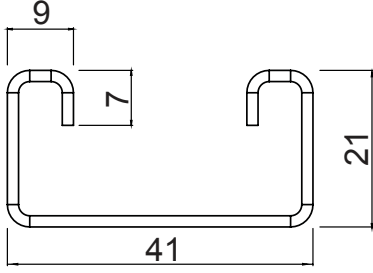

### Tijli Kanal Taşıyıcıları C Tipi - Cable Tray Carrier C Type

SİPARİŞ KODU ORDER CODE	STOK KODU STOCK CODE	L mm	T mm	AĞIRLIK (KG/MT) WEIGHT (KG/MT)
A5-4-10-21C PG	01011A541021CPG	200	1.5	0.225
A5-4-12-21C PG	01011A541221CPG	200	1.5	0.280
A5-4-16-21C PG	01011A541621CPG	300	1.5	0.335
A5-4-20-21C PG	01011A542021CPG	300	1.5	0.335
A5-4-30-21C PG	01011A543021CPG	400	1.5	0.445
A5-4-40-21C PG	01011A544021CPG	500	1.5	0.555
A5-4-50-21C PG	01011A545021CPG	600	1.5	0.665
A5-4-60-21C PG	01011A546021CPG	700	1.5	0.775
A5-4-70-21C PG	01011A547021CPG	800	1.5	0.890
A5-4-80-21C PG	01011A548021CPG	900	1.5	0.995
A5-4-90-21C PG	01011A549021CPG	1000	1.5	1,110
A5-4-100-21C PG	01011A5410021CPG	1100	1.5	1,220
A5-4-10-21C HDG	01011A541021CHDG	200	1.5	0.245
A5-4-12-21C HDG	01011A541221CHDG	200	1.5	0.305
A5-4-16-21C HDG	01011A541621CHDG	300	1.5	0.365
A5-4-20-21C HDG	01011A542021CHDG	300	1.5	0.365
A5-4-30-21C HDG	01011A543021CHDG	400	1.5	0.490
A5-4-40-21C HDG	01011A544021CHDG	500	1.5	0.610
A5-4-50-21C HDG	01011A545021CHDG	600	1.5	0.735
A5-4-60-21C HDG	01011A546021CHDG	700	1.5	0.855
A5-4-70-21C HDG	01011A547021CHDG	800	1.5	0.975
A5-4-80-21C HDG	01011A548021CHDG	900	1.5	1.100
A5-4-90-21C HDG	01011A549021CHDG	1000	1.5	1.220
A5-4-100-21C HDG	01011A5410021CHDG	1100	1.5	1.340

YENİ ÜRÜN  
NEW PRODUCT

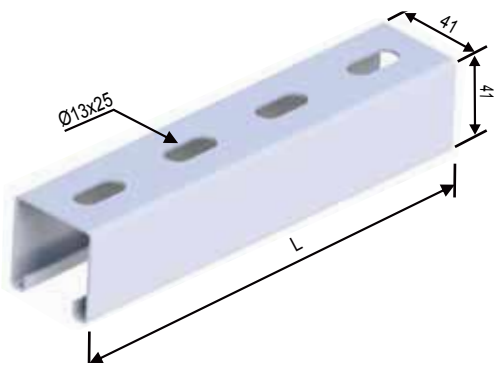
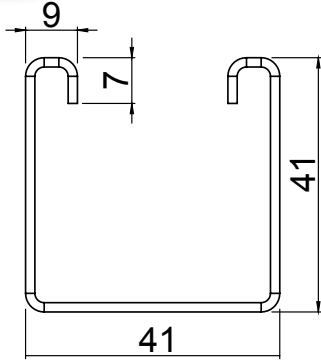

### Tijli Kanal Taşıyıcıları C Tipi - Cable Tray Carrier C Type

SİPARİŞ KODU ORDER CODE	STOK KODU STOCK CODE	L mm	T mm	AĞIRLIK (KG/MT) WEIGHT (KG/MT)
A5-04-10-41C PG	01011A5041041CPG	200	1.5	0.325
A5-04-12-41C PG	01011A5041241CPG	200	1.5	0.410
A5-04-16-41C PG	01011A5041641CPG	300	1.5	0.490
A5-04-20-41C PG	01011A5042041CPG	300	1.5	0.490
A5-04-30-41C PG	01011A5043041CPG	400	1.5	0.650
A5-04-40-41C PG	01011A5044041CPG	500	1.5	0.815
A5-04-50-41C PG	01011A5045041CPG	600	1.5	0.975
A5-04-60-41C PG	01011A5046041CPG	700	1.5	1,140
A5-04-70-41C PG	01011A5047041CPG	800	1.5	1,300
A5-04-80-41C PG	01011A5048041CPG	900	1.5	1,465
A5-04-90-41C PG	01011A5049041CPG	1000	1.5	1,625
A5-04-100-41C PG	01011A50410041CPG	1100	1.5	1,790
A5-04-10-41C HDG	01011A5041041CHDG	200	1.5	0.360
A5-04-12-41C HDG	01011A5041241CHDG	200	1.5	0.450
A5-04-16-41C HDG	01011A5041641CHDG	300	1.5	0.540
A5-04-20-41C HDG	01011A5042041CHDG	300	1.5	0.540
A5-04-30-41C HDG	01011A5043041CHDG	400	1.5	0.715
A5-04-40-41C HDG	01011A5044041CHDG	500	1.5	0.895
A5-04-50-41C HDG	01011A5045041CHDG	600	1.5	1,075
A5-04-60-41C HDG	01011A5046041CHDG	700	1.5	1.255
A5-04-70-41C HDG	01011A5047041CHDG	800	1.5	1,430
A5-04-80-41C HDG	01011A5048041CHDG	900	1.5	1.610
A5-04-90-41C HDG	01011A5049041CHDG	1000	1.5	1,790
A5-04-100-41C HDG	01011A50410041CHDG	1100	1.5	1.970

**Tijli Kanal Taşıyıcıları C Tipi - Cable Tray Carrier C Type**

SİPARİŞ KODU ORDER CODE	STOK KODU STOCK CODE	A mm	W mm	H mm	T mm	AĞIRLIK (KG/MT) WEIGHT (KG/MT)
ACKC-41-211020 PG	01011ACKC41211020PG	60	120	125	2.0	0,430
ACKC-41-211520 PG	01011ACKC41211520PG	90	170	125	2.0	0,540
ACKC-41-212020 PG	01011ACKC41212020PG	110	220	125	2.0	0,640
ACKC-41-213020 PG	01011ACKC41213020PG	160	320	125	2.0	0,840
ACKC-41-214020 PG	01011ACKC41214020PG	210	420	125	2.0	1,050
ACKC-41-211025 PG	01011ACKC41211025PG	60	120	125	2.5	0,430
ACKC-41-211525 PG	01011ACKC41211525PG	90	170	125	2.5	0,540
ACKC-41-212025 PG	01011ACKC41212025PG	110	220	125	2.5	0,640
ACKC-41-213025 PG	01011ACKC41213025PG	160	320	125	2.5	0,840
ACKC-41-214025 PG	01011ACKC41214025PG	210	420	125	2.5	1,050
ACKC-41-211020 HDG	01011ACKC41211020HDG	60	120	125	2.0	0,550
ACKC-41-211520 HDG	01011ACKC41211520HDG	90	170	125	2.0	0,690
ACKC-41-212020 HDG	01011ACKC41212020HDG	110	220	125	2.0	0,810
ACKC-41-213020 HDG	01011ACKC41213020HDG	160	320	125	2.0	1,070
ACKC-41-214020 HDG	01011ACKC41214020HDG	210	420	125	2.0	1,340
ACKC-41-211025 HDG	01011ACKC41211025HDG	60	120	125	2.5	0,550
ACKC-41-211525 HDG	01011ACKC41211525HDG	90	170	125	2.5	0,690
ACKC-41-212025 HDG	01011ACKC41212025HDG	110	220	125	2.5	0,810
ACKC-41-213025 HDG	01011ACKC41213025HDG	160	320	125	2.5	1,070
ACKC-41-214025 HDG	01011ACKC41214025HDG	210	420	125	2.5	1,340

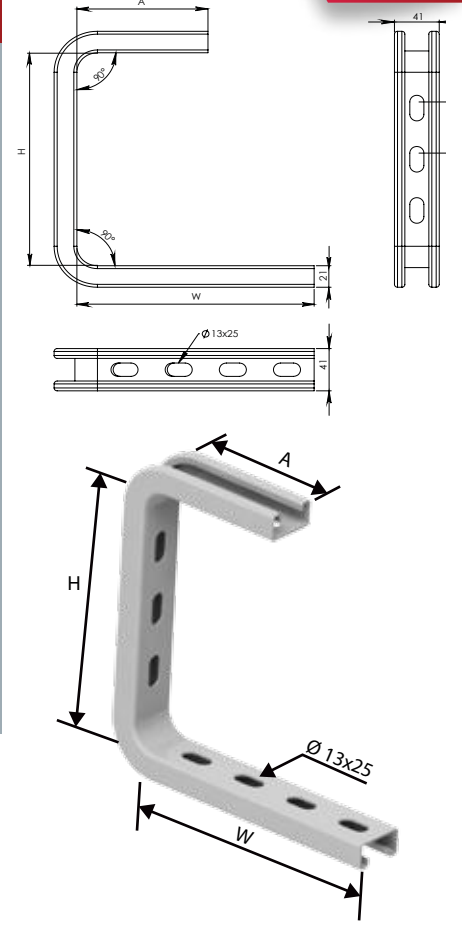
**Tijli Kanal Taşıyıcıları C Tipi - Cable Tray Carrier C Type**

SİPARİŞ KODU ORDER CODE	STOK KODU STOCK CODE	W mm	H mm	T mm	AĞIRLIK (KG/MT) WEIGHT (KG/MT)
ACKL-41-211020 PG	01011ACKL41211020PG	120	125	2.0	0,350
ACKL-41-211520 PG	01011ACKL41211520PG	170	125	2.0	0,420
ACKL-41-212020 PG	01011ACKL41212020PG	220	125	2.0	0,480
ACKL-41-213020 PG	01011ACKL41213020PG	320	125	2.0	0,620
ACKL-41-214020 PG	01011ACKL41214020PG	420	125	2.0	0,760
ACKL-41-211025 PG	01011ACKL41211025PG	120	125	2.5	0,350
ACKL-41-211525 PG	01011ACKL41211525PG	170	125	2.5	0,420
ACKL-41-212025 PG	01011ACKL41212025PG	220	125	2.5	0,480
ACKL-41-213025 PG	01011ACKL41213025PG	320	125	2.5	0,620
ACKL-41-214025 PG	01011ACKL41214025PG	420	125	2.5	0,760
ACKL-41-211020 HDG	01011ACKL41211020HDG	120	125	2.0	0,440
ACKL-41-211520 HDG	01011ACKL41211520HDG	170	125	2.0	0,530
ACKL-41-212020 HDG	01011ACKL41212020HDG	220	125	2.0	0,620
ACKL-41-213020 HDG	01011ACKL41213020HDG	320	125	2.0	0,790
ACKL-41-214020 HDG	01011ACKL41214020HDG	420	125	2.0	0,970
ACKL-41-211025 HDG	01011ACKL41211025HDG	120	125	2.5	0,440
ACKL-41-211525 HDG	01011ACKL41211525HDG	170	125	2.5	0,530
ACKL-41-212025 HDG	01011ACKL41212025HDG	220	125	2.5	0,620
ACKL-41-213025 HDG	01011ACKL41213025HDG	320	125	2.5	0,790
ACKL-41-214025 HDG	01011ACKL41214025HDG	420	125	2.5	0,970

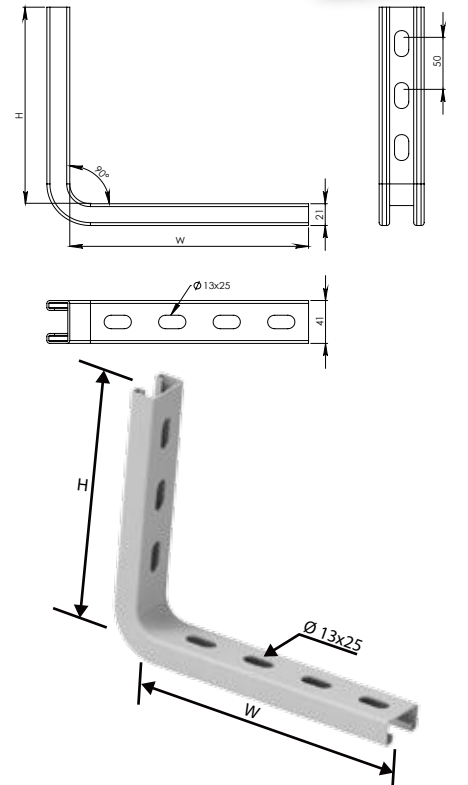

**YENİ ÜRÜN**  
NEW PRODUCT

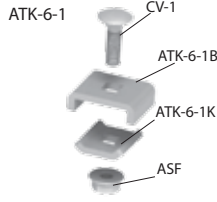

**Tel Örgü Kablo Kanalları Birleştirme Elemanları (E.G TO TS EN 149:2005)**  
Wiremesh Cable Trays Couplers (E.G TO TS EN 149:2005)

SİPARİŞ KODU ORDER CODE	STOK KODU STOCK CODE	T mm	AĞIRLIK (KG/MT) WEIGHT (KG/MT)
<b>ATK-6-1B EG</b>	01006ATK61BEG	3.0	0.075
<b>ATK-6-1K EG</b>	01006ATK61KBEG	3.0	0.085

**YENİ ÜRÜN**  
NEW PRODUCT

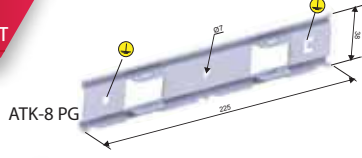

**Tel Örgü Kablo Kanalları Hızlı Birleştirme Elemanları (P.G to EN 10346)**  
Wiremesh Cable Trays Quick Couplers (P.G to EN 10346)

SİPARİŞ KODU ORDER CODE	STOK KODU STOCK CODE	T mm	AĞIRLIK (KG/MT) WEIGHT (KG/MT)
<b>ATK-8 PG</b>	01006ATK8PG	0.9	0.075

**YENİ ÜRÜN**  
NEW PRODUCT



**Tel Örgü Kablo Kanalları Tijli Taşıma Elemanları (P.G to EN 10446)**  
Wiremesh Cable Trays Carrier Which Used Threaded Rod (P.G to EN 10327)

SİPARİŞ KODU ORDER CODE	STOK KODU STOCK CODE	H mm	T mm	AĞIRLIK (KG/MT) WEIGHT (KG/MT)
<b>ATK-10 PG</b>	01006ATK10PG	44	2.0	0.045

**YENİ ÜRÜN**  
NEW PRODUCT

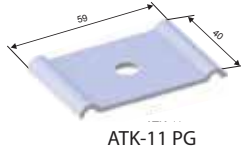

**Tel Örgü Kablo Kanalları Tijli Taşıma Elemanları (P.G to EN 10446)**  
Wiremesh Cable Trays Carrier Which Used Threaded Rod (P.G to EN 10327)

SİPARİŞ KODU ORDER CODE	STOK KODU STOCK CODE	T mm	AĞIRLIK (KG/MT) WEIGHT (KG/MT)
<b>ATK-11 PG</b>	01006ATK12PG	2.0	0,040

**YENİ ÜRÜN**  
NEW PRODUCT



**Bombe Başlı Civata - Mushroom Head Square Neck Bolts**

SİPARİŞ KODU ORDER CODE	STOK KODU STOCK CODE	Metric	L mm	AĞIRLIK (KG/AD) WEIGHT (KG/PCS)
<b>CV</b>	01012BBCV	M6	15	-
<b>CV-1</b>	01012BBCV01	M6	20	0.010
<b>CV-2</b>	01012BBCV02	M8	15	0.012
<b>CV-3</b>	01012CBBCV03	M10	25	0.022

**YENİ ÜRÜN**  
NEW PRODUCT

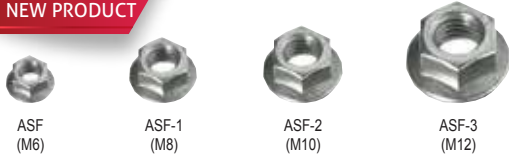

**Flanşlı Somun - Flanged Nuts**

SİPARİŞ KODU ORDER CODE	STOK KODU STOCK CODE	Metric	AĞIRLIK (KG/AD) WEIGHT (KG/PCS)
<b>ASF</b>	01012ASF	M6	0.003
<b>ASF-1</b>	01012ASF01	M8	0.007
<b>ASF-2</b>	01012ASF02	M10	0.011
<b>ASF-3</b>	01012ASF03	M12	0.020

**YENİ ÜRÜN**  
NEW PRODUCT

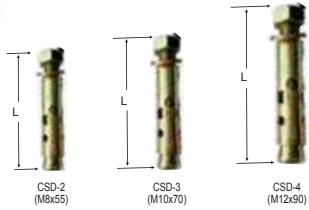

**Sac Gömlek Tip Çelik Dubeller Tip 2 - Stell Wall Peg Type 2**

SİPARİŞ KODU ORDER CODE	STOK KODU STOCK CODE	Metric	L mm	AĞIRLIK (KG/AD) WEIGHT (KG/PCS)
<b>CSD-2</b>	01012STCSD02	M8	55	0,028
<b>CSD-3</b>	01012STCSD03	M10	70	0,060
<b>CSD-4</b>	01012STCSD04	M12	90	0,110

**YENİ ÜRÜN**  
NEW PRODUCT



**Çekmeli Tip Çelik Dubeller (S Tipi) - Stell Wall Peg Type 1 (S Type)**

SİPARİŞ KODU ORDER CODE	STOK KODU STOCK CODE	Metric	AĞIRLIK (KG/AD) WEIGHT (KG/PCS)
<b>CD-2</b>	01012STCD02	M8	0,016
<b>CD-3</b>	01012STCD03	M10	0,030
<b>CD-4</b>	01012STCD04	M12	0,080

**YENİ ÜRÜN**  
NEW PRODUCT



**Askı Tijleri - Threaded Hanging Rod**

SİPARİŞ KODU ORDER CODE	STOK KODU STOCK CODE	Metric	L mm	AĞIRLIK (KG/AD) WEIGHT (KG/PCS)
<b>AT-1</b>	01012AT1	M8	2000	0.650
<b>AT-2</b>	01012AT2	M10	2000	0.960
<b>AT-3</b>	01012AT3	M12	2000	1.360

**CE**

**EC DECLARATION OF CONFORMITY**  
FOLLOWING THE EUROPEAN DIRECTIVE  
2006/95/EC LOW VOLTAGE EQUIPMENT  
YÜKSELTİLMİŞ ALTIYERİ BAĞLI YÜKSELTİMLERİN VE DİĞER  
AT UYGUNLUK BİYANI

**Manufacturer's Name** AK İŞ PLASTİK PROFİL ELEKTRİK SANAYİ VE TİCARET  
LİMİTED ŞİRKETİ  
**Manufacturer's address** İSTİKLAL ÖZEL SAN. BÖLGE, TÜRKİYE ÖZEL CAD. D BLOK  
NO:8 K:4/02 BAĞAÇDEĞİR / İSTANBUL / TÜRKİYE  
**Phone** +90 212 671 39 79  
**Fax** +90 212 671 39 76  
**Web** www.akisplastik.com.tr  
**E-mail** info@akisplastik.com.tr

**Product description** Cable trunking systems and cable ducting systems for  
electrical installations  
Domestik kablolama sistemleri ve kablolama aksesuarları  
elektrik tesisatları için

**herewith declare that the products in above**  
are in conformity with the provisions of the following essential requirements of EC Directives and  
standards when installed in accordance with the installation instructions contained in the product  
documentation

Takiben her bir ürünün kullanımına uygulanacak belgelerin Avrupa Topluluğu (AT) tarafından yayınlanmış olan ilgili  
Avrupa Topluluğu (AT) direktiflerine ve standartlarına tam olarak uydu ve genelinde geçerli olan standartlara  
uydu olarak

**European directive(s)** Low Voltage Equipment Directive (2006/95/EC)  
İlgili AT direktifleri

**European standard(s)** EN 50065-1:2005  
EN 50065-2-1:2006/AL:2011  
EN 50065-2-2:2010

**The last two digits of the year in which  
the CE marking was affixed** 13  
CE işaretinin uygulanma yılına ilişkin son iki  
hasedir.

**For and on behalf of the AK İŞ PLASTİK PROFİL ELEKTRİK SANAYİ VE TİCARET LİMİTED ŞİRKETİ;  
AK İŞ PLASTİK PROFİL ELEKTRİK SANAYİ VE TİCARET LİMİTED ŞİRKETİ adına,  
Signature**  
İsmail İsmail  
  
**İsmail İsmail, General Manager (Genel Müdür)**  
Issued in (Yayımlandığı yer) İSTANBUL / TÜRKİYE Issue date (Yayımlandığı tarih) 03 / 06 / 2013

**TSE**

**TSE DENEY VE KALİBRASYON MERKEZİ BAŞKANLIĞI**  
**Elektronik ve Makine Laboratuvar Grup Başkanlığı (Gözetim)**  
**Elektronik Laboratuvarı Ankara Müdürlüğü**  
Atatürk Bulvarı Kat: No:12 06100 Beşevler Cadde: 458/803  
Kat: No: 06100/06102 Kat: No: 06100/06103 Kat: No: 06100/06104  
HACIHALİM ÖZGEN TEST VE KALİBRASYON MERKEZİ  
ELECTROTECHNICAL LABORATORY (ANKARA)  
Atatürk Bulvarı Kat: No:13 06100 Beşevler Cadde: 458/804  
Kat: No: 06100/06105 Kat: No: 06100/06106 Kat: No: 06100/06107 Kat: No: 06100/06108

2013/17  
02-13

**MUAYENE VE DENEY RAPORU**  
**TEST REPORT**

**Deneyi Talep Eden** AK İŞ PLASTİK PROFİL ELEKTRİK SAN. VE TİC. LTD.ŞTİ  
(Müşteri Adı ve Adresi)

**Deneyi Talep Tarihi/No** 02.02.2013 / 021318  
(Talep Tarihi / No)

**Deneyin Yapıldığı Tarih** 02.02.2013  
(Deneyin Yapıldığı Tarih)

**Uygulanır Standart / Metod** TS EN 50065-2-1:2007-06 (Domestik kablolama sistemleri ve kablolama aksesuarları -  
Elektrik tesisatları için - Bölüm 2-1. Deneylere ve testlere ilişkin zorunlu olan diğer  
deneylere kablolama sistemleri ve kablolama aksesuarları için)

**Uygulanır Standart / Metod** TS EN 50065-2-1:2007-06 (Domestik kablolama sistemleri ve kablolama aksesuarları -  
Elektrik tesisatları için - Bölüm 2-1. Deneylere ve testlere ilişkin zorunlu olan diğer  
deneylere kablolama sistemleri ve kablolama aksesuarları için)

**Appliyed Standard / Method**

**Raporun Sayfa Sayısı** 8  
(Raporun Sayfa Sayısı)

**Açıklamalar** CE, DENEY  
(Açıklamalar)

**Notlar**

Yukarıda belirtilen testler için laboratuvarımızda yapılan deneylerin ve deneyler için elde edilen sonuçların raporları aşağı listelenmiştir.  
The testing and/or measurement results are given on the following pages which are part of this report.

Bu rapor (ve/veya deney raporları) istenilen amaçları doğrultusunda, standartlara uygunluk (veya uyumsuzluk) belirlemek için kullanılabilir. Ancak, bu rapor kesinlikle bir garanti vermez ve sadece bir deneysel bulgudur. Bu rapor, bir deneysel bulgudur ve sadece bir deneysel bulgudur. Bu rapor, bir deneysel bulgudur ve sadece bir deneysel bulgudur.

**Mühür** Tarih 02.02.2013  
**Deney Sorumlusu** F. AYLAZ  
**Deney Yapan** M. YENİMA  
**Deney Yapanın Adı** M. YENİMA  
**Deney Yapanın Adresi** ÇELİK BORULAR, SİGORTA KUTUSU KLEMENSLERİ, ABS PANO, ASPIRATÖR, AYDINLATIMLAR, GRUP PRİZLERİ VE ELEKTRİK MALZEMELERİ SATIŞI  
**Deney Yapanın Adresi** MANİFAKATÇI VE İMALATÇI  
**Deney Yapanın Adresi** MANİFAKATÇI VE İMALATÇI

**RoHS DECLARATION OF CONFORMITY**  
FOLLOWING THE EUROPEAN DIRECTIVE  
2011/65/EU RESTRICTION OF THE USE OF CERTAIN HAZARDOUS SUBSTANCES (RoHS)  
2011/65/EU BAZI BELİRLİ ZARARLI MADDELERİN KULLANIMINI KESTİRME  
YÖNETMELİĞİ VE DİĞER UYGUNLUK BİYANI

**Manufacturer's Name** AK İŞ PLASTİK PROFİL ELEKTRİK SANAYİ VE TİCARET  
LİMİTED ŞİRKETİ  
**Manufacturer's address** İSTİKLAL ÖZEL SAN. BÖLGE, TÜRKİYE ÖZEL CAD. D BLOK  
NO:8 K:4/02 BAĞAÇDEĞİR / İSTANBUL / TÜRKİYE  
**Phone** +90 212 671 39 79  
**Fax** +90 212 671 39 76  
**Web** www.akisplastik.com.tr  
**E-mail** info@akisplastik.com.tr

**Product description** Cable trunking systems and cable ducting systems for  
electrical installations  
Domestik kablolama sistemleri ve kablolama aksesuarları  
elektrik tesisatları için

**herewith declare that the products in above**  
are in conformity with the provisions of the following EC Directive when installed in accordance  
with the installation instructions contained in the product documentation

Takiben her bir ürünün kullanımına uygulanacak belgelerin Avrupa Topluluğu (AT) tarafından yayınlanmış olan ilgili  
Avrupa Topluluğu (AT) direktiflerine ve standartlarına tam olarak uydu ve genelinde geçerli olan standartlara  
uydu olarak

**European directive(s)** RESTRICTION OF THE USE OF CERTAIN HAZARDOUS  
SUBSTANCES (RoHS) (2011/65/EU)  
İlgili AT direktifleri

**Heavy Metals (Pb/Cd)**

Test Name(s)	Unit	Test Method	Results	SDA	Limit
Cadmium (Cd)	mg/kg	9000 reference to IEC 62321:2006, and performed by ICP-AES	n.d.	3	100
Cobalt (Co)	mg/kg	9000 reference to IEC 62321:2006, and performed by ICP-AES	n.d.	3	1000
Mercury (Hg)	mg/kg	9000 reference to IEC 62321:2006, and performed by ICP-AES	n.d.	2	1000
Hexavalent Chromium (CrVI)	mg/kg	9000 reference to IEC 62321:2006, and performed by UV-VIS	n.d.	2	1000

**Notes:** mg/kg = ppm; 3 parts = 1000 ppm  
(3) n.d. = not detected  
(3) IEC = Method Detection Limit

**For and on behalf of the AK İŞ PLASTİK PROFİL ELEKTRİK SANAYİ VE TİCARET LİMİTED ŞİRKETİ;  
AK İŞ PLASTİK PROFİL ELEKTRİK SANAYİ VE TİCARET LİMİTED ŞİRKETİ adına,  
Signature**  
İsmail İsmail  
  
**İsmail İsmail, General Manager (Genel Müdür)**  
Issued in (Yayımlandığı yer) İSTANBUL / TÜRKİYE Issue date (Yayımlandığı tarih) 03 / 07 / 2013

**ASE**

**KALİTE YÖNETİMİ**  
**QUALITY MANAGEMENT**

**AK-İŞ PLASTİK PROFİL ELEKTRİK  
SAN. VE TİC. LTD. ŞTİ.**  
İstanbul  
İOSB Eski Turgut Özal Cad. D Blok No:8/402  
Bağaçdeğir / İstanbul / Türkiye

**PVC KABLO KANALI VE AKSESUARLARI İMALATI, PLASTİK VE ÇELİK BORULAR, SİGORTA KUTUSU KLEMENSLERİ, ABS PANO, ASPIRATÖR, AYDINLATIMLAR, GRUP PRİZLERİ VE ELEKTRİK MALZEMELERİ SATIŞI**  
**MANUFACTURING OF PVC CABLE CHANNEL AND ACCESSORIES, SALES OF PLASTIC AND STEEL PIPES, FUSE BOX CONNECTOR, ABS PANEL, ASPIRATOR, ILLUMINATIONS, GROUP SOCKETS ETC. ELECTRICAL MATERIALS**

**ISO 9001: 2015**  
Standard belgelenmiş yönetim süreçleri belgelenmiştir  
(The complete of the standard has been documented)

**16. Yayımlı Tarihi / Date First Issued** : 26.12.2017  
**Yayımlı Tarihi / Date Certificate Issued** : 26.12.2017  
**Geçerlilik Periyodu / Period of Registration** : 3 Yıl / Years  
**Geçerlilik Tarihi / Date Certificate Expires** : 23.12.2018  
**Sertifika Numarası / Certificate No** : 01-1061701

**IAF** **JAS-ANZ**

**Notlar:**  
Bu sertifikayı elde eden kuruluş, sertifikasını kullanırken ISO 9001:2015 standardının tüm gerekliliklerine uygun olarak çalışmalıdır. Sertifikasyon kuruluşu, sertifikasyon süreciyle ilgili olarak müşteriye destek sağlar.  
The holder of this certificate, when using it for the purposes of certification, shall conform to all the provisions of the ISO 9001:2015 standard. The certification body provides support to the client in relation to the certification process.

402 Belgeleme Belgeleri Sistemleri ve İşletim Sistemi (ISO 9001:2015) / 402 Belgeleme Belgeleri Sistemleri ve İşletim Sistemi (ISO 9001:2015)  
Talep ve İnceleme: Akis Plastik Sanayi ve Ticaret Limited Şirketi / TÜRKİYE Tel: +90 212 671 39 79 Fax: +90 212 671 39 76 E-mail: info@akisplastik.com.tr  
Bu belgeyi talep eden bir kişi veya kuruluşun belgelenmiş olduğu kuruluşun ISO 9001:2015 standardına uygun olduğunu göstermektedir.  
The holder of this certificate is a person or organization that has been certified to conform to the ISO 9001:2015 standard.







ELECTRICAL MATERIALS



**AKIS**  
PLASTIC

İ.O.S.B. Eski Turgut Özal Cad. Altıntaş İş Mrk. No:8 D Blok No:4/402  
İkitelli - Başakşehir / İSTANBUL / TÜRKİYE

+90 212 671 44 71 +90 212 671 44 28

info@akisplastik.com.tr export@akisplastik.com.tr

www.akisplastik.com.tr