



2024 FİYAT LİSTESİ

www.akisplastik.com.tr



ELECTRICAL MATERIALS

AKIS

P L A S T I C



HAKKIMIZDA - ABOUT US

Hakkımızda

Fabrikamız 2012 yılında İstanbul'da kurulmuştur, 10.000 mt2 kapalı alanda pvc kablo kanalı, abs ve pc elektrik panoları, çelik ve izoleli çelik spiral, aspiratör vb. elektrik malzemeleri üretimi yapmaktadır.

Yıllık 24.000.000 mt kablo kanalı, 480.000 adet elektrik panosu, 3.000.000 çelik spiral ve 250.000 adet aspiratör üretim kapasitesi ile kaliteden hiçbir şekilde ödün vermeden siz değerli iş ortaklarımızla daha büyük hedeflere ilerlemektedir. Otuz yıllık bilgi birikimi ve deneyimlerimize güvenerek siz değerli müşterilerimize hizmet vermekten gurur duyuyoruz. Globalleşen dünyada bir adım öne çıkmanın yolu istikrarlı çalışmak daha kaliteli ürün ve hizmet vermekten geçmekte olduğunun bilincindeyiz. Daimi sloganımız ve nihai hedefimiz siz değerli müşterilerimizin memnuniyetidir.

About Us

Our company was built in 2012 in Istanbul. Our factory is with an area of 10.000 m2 in the production cable trunkings products, Abs and Pc panel boards, Steel and Insulated steel spiral, Aspirator and etc. electrical materials.

With an annual production capacity of 24,000,000 mt of cable trunking, 480,000 pieces of electrical panels, 3,000,000 mt steel spirals and 250,000 aspirators, it is advancing towards greater goals with you, our valuable business partners, without compromising on quality. We are proud to serve our valued customers, trusting our thirty years of knowledge and experience. We are aware that the way to stand out in the globalizing world is to work consistently and to provide better quality products and services. Our motto and our ultimate goal is the satisfaction of our customers.

تأسس مصنعنا في عام 2012 في اسطنبول

حلزونات فولاذية وفولاذية معزولة ، شفاطة وما إلى ذلك في منطقة مغلقة تبلغ 10.000 متر مربع. تصنع المعدات ، PC و ABS لوحات كهربائية ، PVC مجاري كابل الكهربائية.

بفضل طاقتها الإنتاجية السنوية البالغة 24.000.000 طن متري من مجاري الكابلات ، و 480.000 لوحة كهربائية ، و 3.000.000 من اللوالب الفولاذية و 250.000 شفاط ، فإنها تتقدم نحو أهداف أكبر مع شركائنا التجاريين القيمين ، دون المساومة على الجودة. نفخر بخدمتكم ، عملائنا الكرام ، من خلال الاعتماد على ثلاثين عامًا من المعرفة والخبرة. نحن ندرك أن السبيل للمضي قدمًا في عالم العولمة هو العمل باستمرار وتقديم منتجات وخدمات ذات جودة أفضل. شعارنا الدائم وهدفنا النهائي هو إرضاء عملائنا الكرام.

İÇERİK - INDEX

KAPALI TİP KABLO KANALLARI - CLOSED TYPE CABLE TRUNKINGS	01 - 08
İÇTEN KAPAKLI KABLO KANALI VE AKSESUARLARI - INSIDE COVER CABLE TRUNKING AND ACCESSORIES	09
MONTAJ TAMAMLAMA AKSESUARLARI - ASSEMBLY ACCESSORIES	10
YAPIŞKAN BANTLI KABLO KANALLARI - SELF ADHESIVE CABLE TRUNKINGS	11
ZEMİN ÜSTÜ (BALIK SIRTİ) PVC KABLO KANALLARI GRİ - OVERFLOOR PVC CABLE TRUNKINGS GREY	12
DELİKLİ (PANO TİPİ) PVC KABLO KANALLARI GRİ - PVC SLOTTED CABLE TRUNKINGS GREY	13 - 16
ASPIRATÖR - ASPIRATORS	17
ABS PANO - ABS BOARD	18 - 21
SUSTALAR VE KABLO MAKARASI - SPRINGS AND CABLE REEL	22
BORULAR - CONDUITS	23 - 28
KABLO KELEPÇESİ VE KABLO BAĞLARI - CABLE CLAMP AND CABLE TIES	29
SERTİFİKALAR - CERTIFICATES	30 - 31



Mekanik Darbelere dayanıklı.
Resistance to mechanical
shock hits 2 Joule



Topraklama gerekmez.
No need for grounding



Alev aldığıında kendiliğinden sönebilen katkı maddeli PVC malzeme (UL94V0 M1).
Self extinguishing PVC fire reaction (UL94V0 M1)

Kapalı tip kablo kanallarımızın teknik özellikleri

Technical specifications for closed type cable trunkings



Ultraviyole ışıklara dayanıklı (UV).
Resistance to ultraviolet lights (UV)



Boyanabilir.
Paintable



İstenilen boyutta kesilebilir.
Cut down to required size

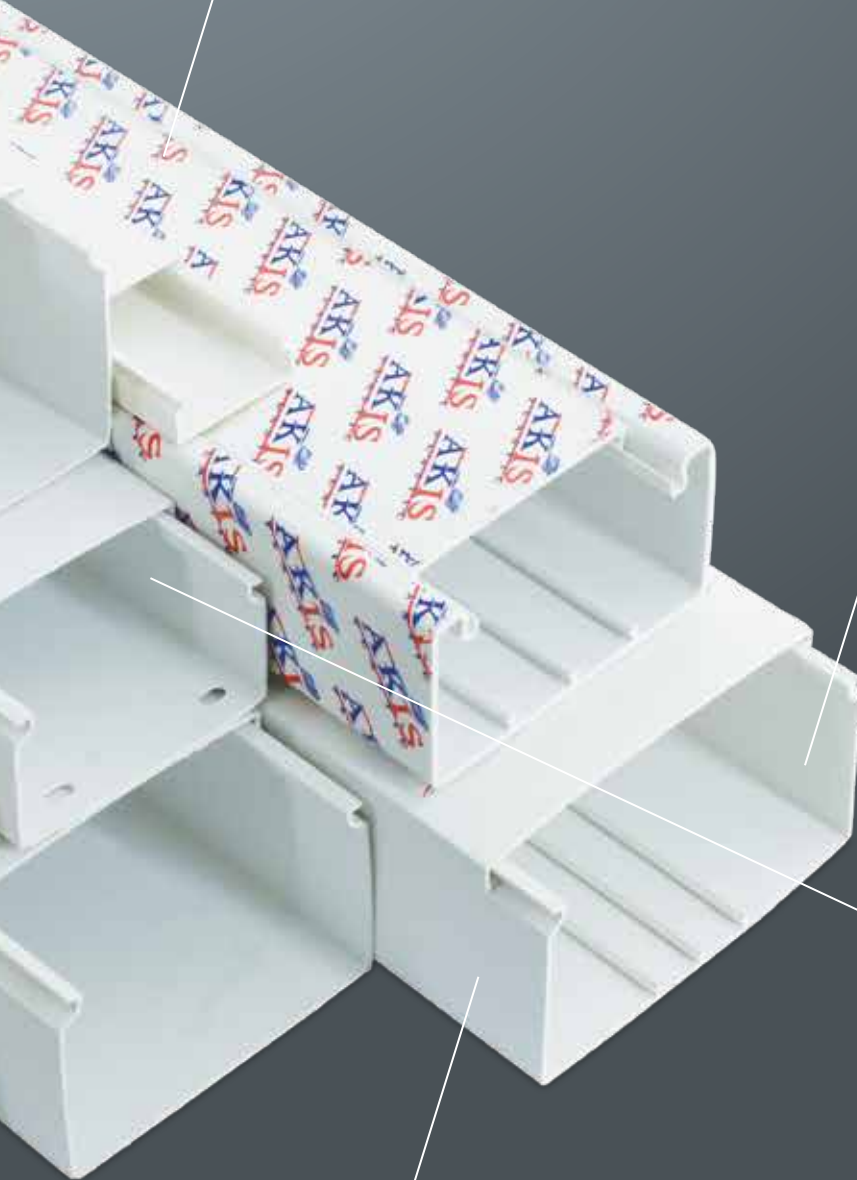



12 x 12

9,30 ₺

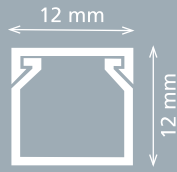

Ürün Kodu - Product Code

APSK - 12012 Kutulu

Kutu - Box

Paket / Metre - Package / Meter

320 mt



15 x 10

10,15 ₺

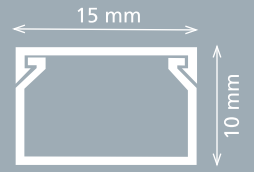

Ürün Kodu - Product Code

APSK - 15010 Kutulu

Kutu - Box

Paket / Metre - Package / Meter

300 mt



16 x 16

11,75 ₺

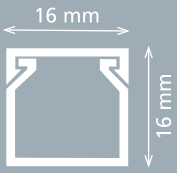

Ürün Kodu - Product Code

APSK - 16016 Kutulu

Kutu - Box

Paket / Metre - Package / Meter

266 mt



20 x 10

12,35 ₺

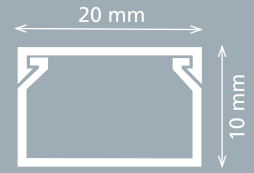

Ürün Kodu - Product Code

APSK - 20010 Kutulu

Kutu - Box

Paket / Metre - Package / Meter

240 mt

**25 x 16**

17,60 ₺

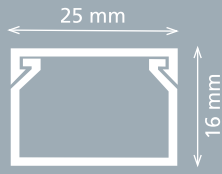

Ürün Kodu - Product Code

APSK - 25016 Kutulu

Kutu - Box

Paket / Metre - Package / Meter

154 mt

**25 x 25**

22,00 ₺

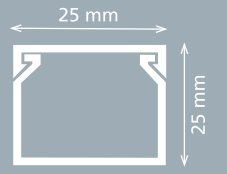

Ürün Kodu - Product Code

APSK - 25025 Kutulu

Kutu - Box

Paket / Metre - Package / Meter

96 mt

**30 x 20**

26,00 ₺

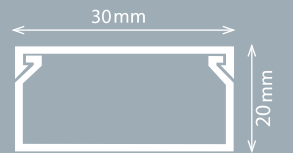

Ürün Kodu - Product Code

APSK - 30020 Kutulu

Kutu - Box

Paket / Metre - Package / Meter

100 mt



40 x 16

29,50 ₺

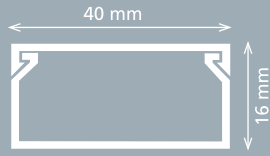

Ürün Kodu - Product Code

APSK - 40016 Kutulu

Kutu - Box

Paket / Metre - Package / Meter

84 mt



40 x 25

31,00 ₺

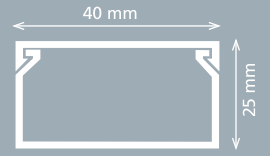

Ürün Kodu - Product Code

APSK - 40025 Kutulu

Kutu - Box

Paket / Metre - Package / Meter

80 mt



40 x 40

35,40 ₺

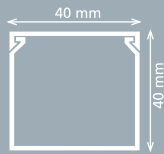

Ürün Kodu - Product Code

APSK - 40040 Kutulu

Kutu - Box

Paket / Metre - Package / Meter

72 mt



50 x 50

63,50 ₺

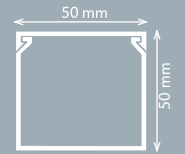

Ürün Kodu - Product Code

APSK - 50050 Kutulu

Kutu - Box

Paket / Metre - Package / Meter

48 mt

**60 x 40**

60,00 ₺

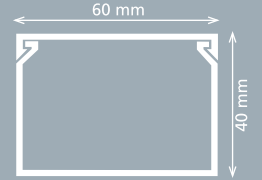

Ürün Kodu - Product Code

APSK - 60040 Kutulu

Kutu - Box

Paket / Metre - Package / Meter

48 mt

**60 x 60**

83,00 ₺

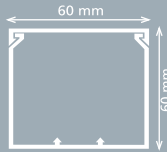

Ürün Kodu - Product Code

APSK - 60060 Kutulu

Kutu - Box

Paket / Metre - Package / Meter

40 mt

**YENİ ÜRÜN**
NEW PRODUCT**75 x 75**

107,00 ₺

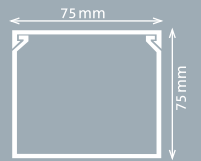

Ürün Kodu - Product Code

APSK - 75075 Kutulu

Kutu - Box

Paket / Metre - Package / Meter

24 mt



80 x 40

88,00 ₺

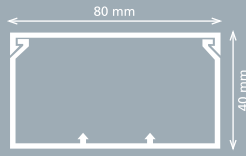

Ürün Kodu - Product Code

APSK - 80040 Kutulu

Kutu - Box

Paket / Metre - Package / Meter

36 mt



80 x 60

93,00 ₺

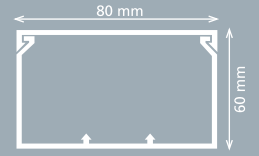

Ürün Kodu - Product Code

APSK - 80060 Kutulu

Kutu - Box

Paket / Metre - Package / Meter

32 mt



100 x 100

175,00 ₺

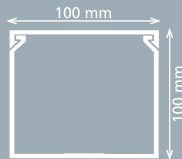

Ürün Kodu - Product Code

APSK - 100100 Kutulu

Kutu - Box

Paket / Metre - Package / Meter

16 mt



100 x 40

103,00 ₺

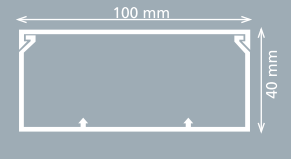

Ürün Kodu - Product Code

APSK - 100040 Kutulu

Kutu - Box

Paket / Metre - Package / Meter

28 mt

**100 x 60**

165,00 ₺

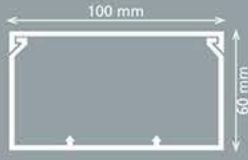

Ürün Kodu - Product Code

APSK - 100060 Kutulu

Kutu - Box

Paket / Metre - Package / Meter

24 mt

**YENİ ÜRÜN
NEW PRODUCT**

Ara bölme takılabilir - Partition can be attached

120 x 60

215,90 ₺

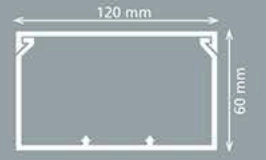

Ürün Kodu - Product Code

APSK - 120060 Kutulu

Kutu - Box

Paket / Metre - Package / Meter

20 mt

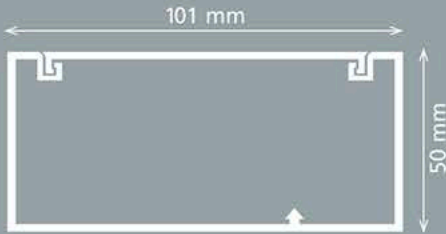
101 x 50

Ürün Kodu - Product Code

APSK - 10150

Uzunluk - Length 2m

Kesit - Section 101 x 50

Ambalaj Miktarı (m) - Package Total (m) 16 Mt.

Ambalaj Şekli - Package Koli - Carton Box

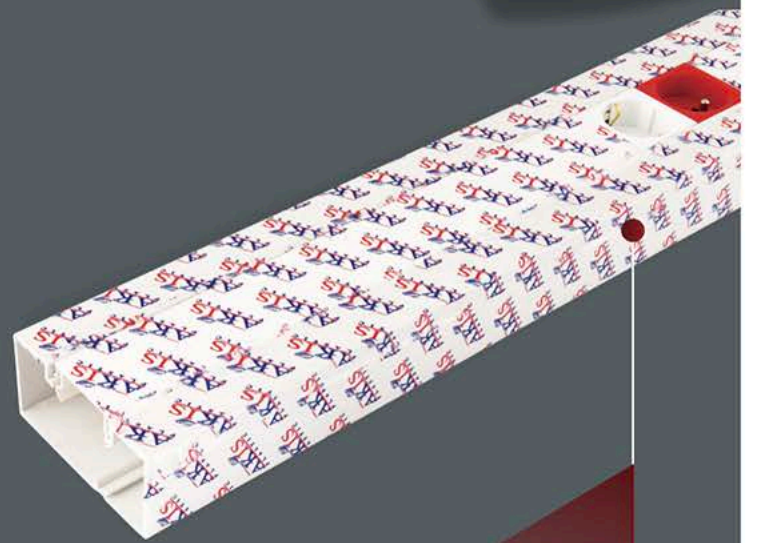
Fiyat**195,00 ₺****YENİ ÜRÜN
NEW PRODUCT****Çerçevesiz
Priz Montajı**Frameless
Socket Assembly

100 x 50

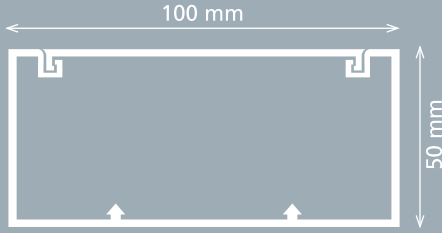

Ürün Kodu - Product Code

APSK - 100050

Uzunluk - Length 2m

Kesit - Section 100 x 50

Ambalaj Miktarı (m) - Package Total (m) 16 Mt.

Ambalaj Şekli - Package Koli - Carton Box

Fiyat 137,00 ₺

3 ara bölme takılabilir - Up to 3 divider possibility

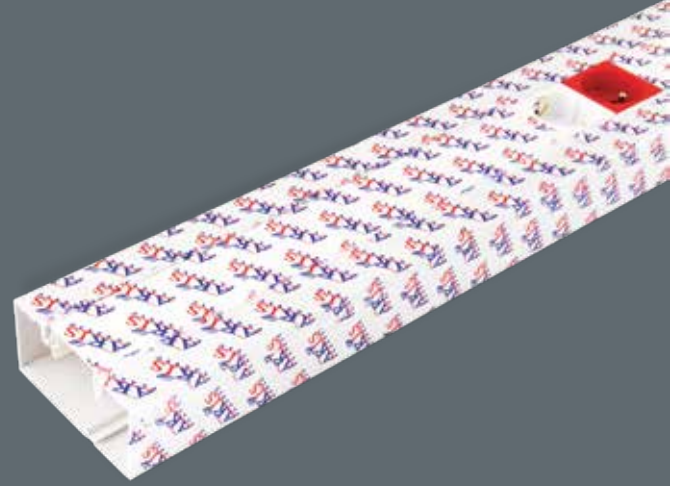

TSE 130124-TSE-02/02

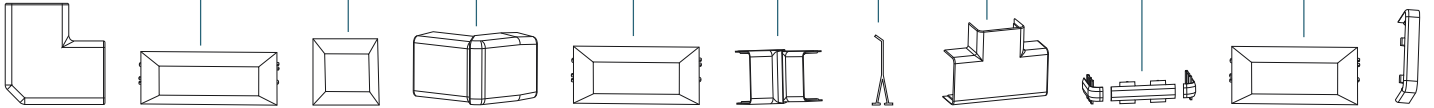
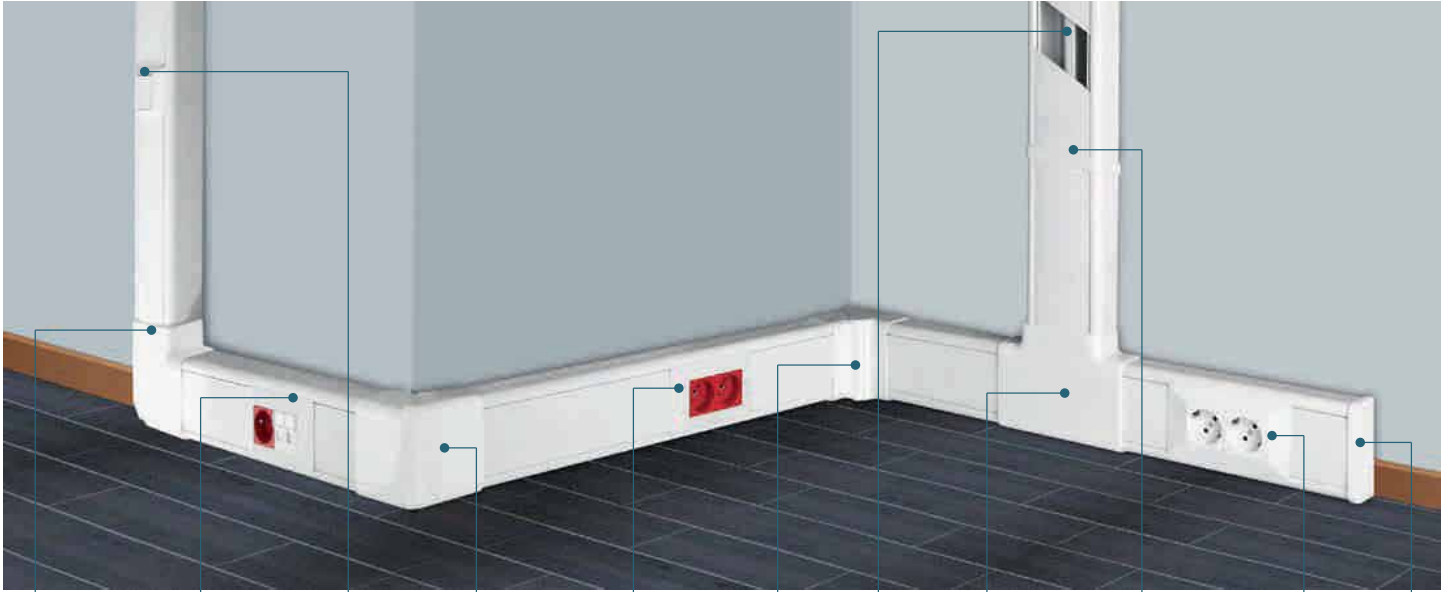

AP-150AB

Ara Bölme
Divider
Kutu: 100 Mt.
Box: 100 Pcs.

45,50 ₺

AP-1501-K

İç Köşe (Bağlantı Elemanı) Hareketli
Internal Corner
Kutu: 12 adet
Box: 12 Pcs.

44,35 ₺

AP-150DK

Dış Köşe (Bağlantı Elemanı) Hareketli
External Corner
Kutu: 10 adet
Box: 10 Pcs.

50,45 ₺

AP-150L

L Bağlantı Elemanı 90° Sabit
90° Corner Piece
Kutu: 12 adet
Box: 12 Pcs.

54,43 ₺

AP-150T

T Bağlantı Elemanı Sabit
 T Branches
 Kutu: 12 Adet
 Box: 12 Pcs.

55,31 ₺

AP-150P

Uç Tipi
 End Cover
 Kutu: 24 Adet
 Box: 24 Pcs.

17,53 ₺

AP-150KB

Ek Parça
 Junction Piece
 Kutu: 24 Adet
 Box: 24 Pcs.

19,22 ₺

AP-150 TP

Tekli 80 x 80 Priz Montaj Seti
 Single Frame Cover Set For 80 x 80
 Kutu: 12 Adet
 Box: 12 Pcs.

25,50 ₺

AP-150T45

Tekli 45 x 45 Priz Montaj Seti
 Single Frame Cover Set For 45 x 45
 Kutu: 12 Adet
 Box: 12 Pcs.

29,65 ₺

AP-150L45

İkili 45 x 45 Priz Montaj Seti
 Double Frame Cover Set For 45 x 45
 Kutu: 12 Adet
 Box: 12 Pcs.

34,15 ₺

AP-150U45

Üçlü 45 x 45 Priz Montaj Seti
 Triple Frame Cover Set For 45 x 45
 Kutu: 12 Adet
 Box: 12 Pcs.

53,62 ₺

AP-150D45

Dörtlü 45 x 45 Priz Montaj Seti
 Quadruple Frame Cover Set For 45 x 45
 Kutu: 20 Adet
 Box: 20 Pcs.

63,51 ₺

AP-110T

İngiliz Tip Tekli Priz Çerçevesi
 British Type Socket Frame
 Kutu: 100
 Box: 100

81,00 ₺

AP-111T

İngiliz Tip İkili Priz Çerçevesi
 British Type Double Socket Frame
 Kutu: 100
 Box: 100

87,50 ₺

AP-150FP02

45x45 Data ve Telefon Priz Kapağı Tekli
 45x45 Data and Telephone Socket Single
 Kutu : 10 adet
 Box : 100 Pcs.

37,32 ₺

AP-150FP

45x45 Data ve Telefon Priz Kapağı 2'li
 45x45 Data and Telephone Socket Double
 Kutu: 25
 Box: 100 Pcs.

56,50 ₺

AP-150UPS

45 x 45 Tekli UPS Priz
 Single UPS Socket
 Kutu: 100 Adet
 Box: 100 Pcs.

95,24 ₺

AP-150UPST

Tekli Şebeke Priz
 Single Graunded Socket
 Kutu: 100 Adet
 Box: 100 Pcs.

81,30 ₺

AP-150DT02

CAT5 Data
 CAT5 Data
 Kutu: 100 Adet
 Box: 100 Pcs.

47,89 ₺

AP-150DT03

CAT6 Data
 CAT6 Data
 Kutu: 100 Adet
 Box: 100 Pcs.

49,35 ₺



12 mm
12 mm

10,30 ₺

12 x 12

Ürün Kodu : APSKY 12012
Kablo Kanalı Bantlı
Ambalaj : 320 m
Self Adhesive Cable Trunking
Box : 320 m



15 mm
10 mm

12,30 ₺

15 x 10

Ürün Kodu : APSKY 15010
Kablo Kanalı Bantlı
Ambalaj : 300 m
Self Adhesive Cable Trunking
Box : 300 m



16 mm
16 mm

12,30 ₺

16 x 16

Ürün Kodu : APSKY 16016
Kablo Kanalı Bantlı
Ambalaj : 250 m
Self Adhesive Cable Trunking
Box : 250 m



20 mm
10 mm

14,50 ₺

20 x 10

Ürün Kodu : APSKY 20010
Kablo Kanalı Bantlı
Ambalaj : 240 m
Self Adhesive Cable Trunking
Box : 240 m



25 mm
16 mm

18,60 ₺

25 x 16

Ürün Kodu : APSKY 25016
Kablo Kanalı Bantlı
Ambalaj : 154 m
Self Adhesive Cable Trunking
Box : 154 m



25 mm
25 mm

24,00 ₺

25 x 25

Ürün Kodu : APSKY 25025
Kablo Kanalı Bantlı
Ambalaj : 96 m
Self Adhesive Cable Trunking
Box : 96 m



40 mm
16 mm

31,50 ₺

40 x 16

Ürün Kodu : APSKY 40016
Kablo Kanalı Bantlı
Ambalaj : 84 m
Self Adhesive Cable Trunking
Box : 84 m



40 mm
25 mm

34,30 ₺

40 x 25

Ürün Kodu : APSKY 40025
Kablo Kanalı Bantlı
Ambalaj : 80 m
Self Adhesive Cable Trunking
Box : 80 m



40 mm
40 mm

42,00 ₺

40 x 40

Ürün Kodu : APSKY 40040
Kablo Kanalı Bantlı
Ambalaj : 72 m
Self Adhesive Cable Trunking
Box : 72 m



60 mm
40 mm

70,50 ₺

60 x 40

Ürün Kodu : APSKY 60040
Kablo Kanalı Bantlı
Ambalaj : 48 m
Self Adhesive Cable Trunking
Box : 48 m

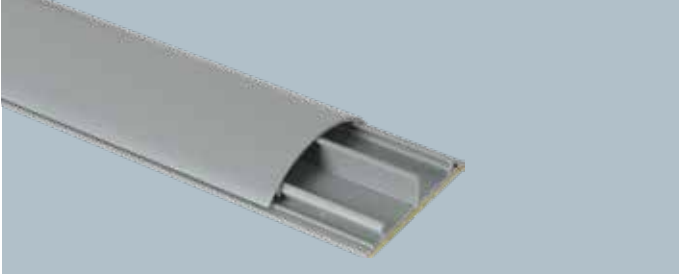
**50 x 12**

70,00 ₺

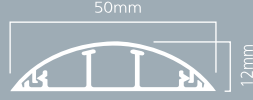

Ürün Kodu - Product Code
APSZ 500 x 12

Ambalaj Miktarı - Package Total 60 m

Ambalaj Şekli - Package Kutu - Box

**50 x 12**

81,50 ₺

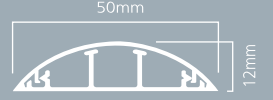

Ürün Kodu - Product Code
APSZY 500 x 12

Ambalaj Miktarı - Package Total 60 m

Ambalaj Şekli - Package Kutu - Box

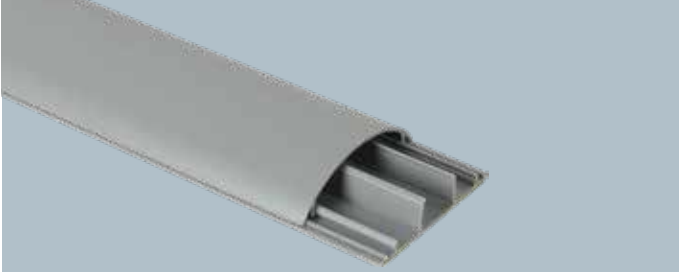
**70 x 20**

134,00 ₺

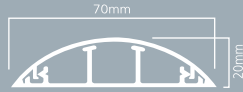

Ürün Kodu - Product Code
APSZ 700 x 12

Ambalaj Miktarı - Package Total 60 m

Ambalaj Şekli - Package Kutu - Box

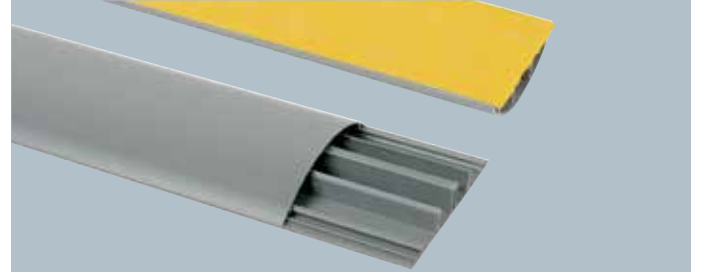
**70 x 20**

150,00 ₺

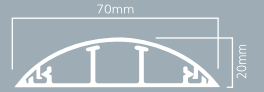

Ürün Kodu - Product Code
APSZY 700 x 12

Ambalaj Miktarı - Package Total 60 m

Ambalaj Şekli - Package Kutu - Box

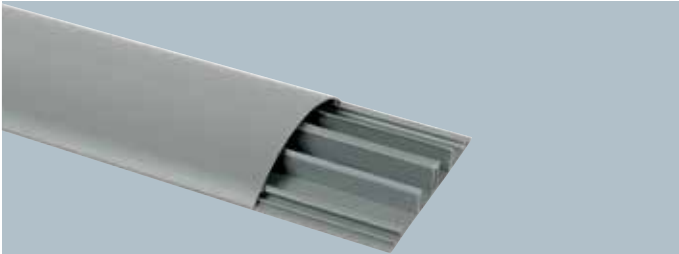
**90 x 20**

174,00 ₺

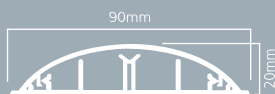

Ürün Kodu - Product Code
APSZ 900 x 20

Ambalaj Miktarı - Package Total 20 m

Ambalaj Şekli - Package Kutu - Box

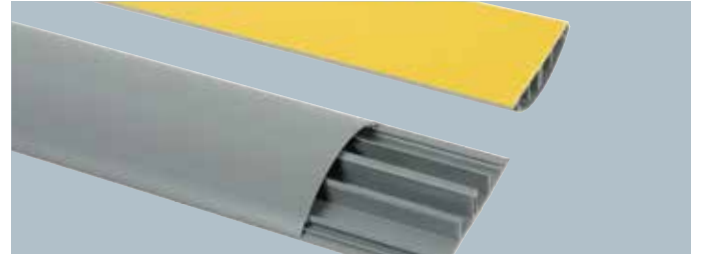
**90 x 20**

190,00 ₺

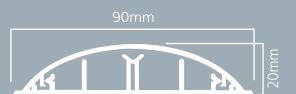

Ürün Kodu - Product Code
APSZY 900 x 20

Ambalaj Miktarı - Package Total 20 m

Ambalaj Şekli - Package Kutu - Box

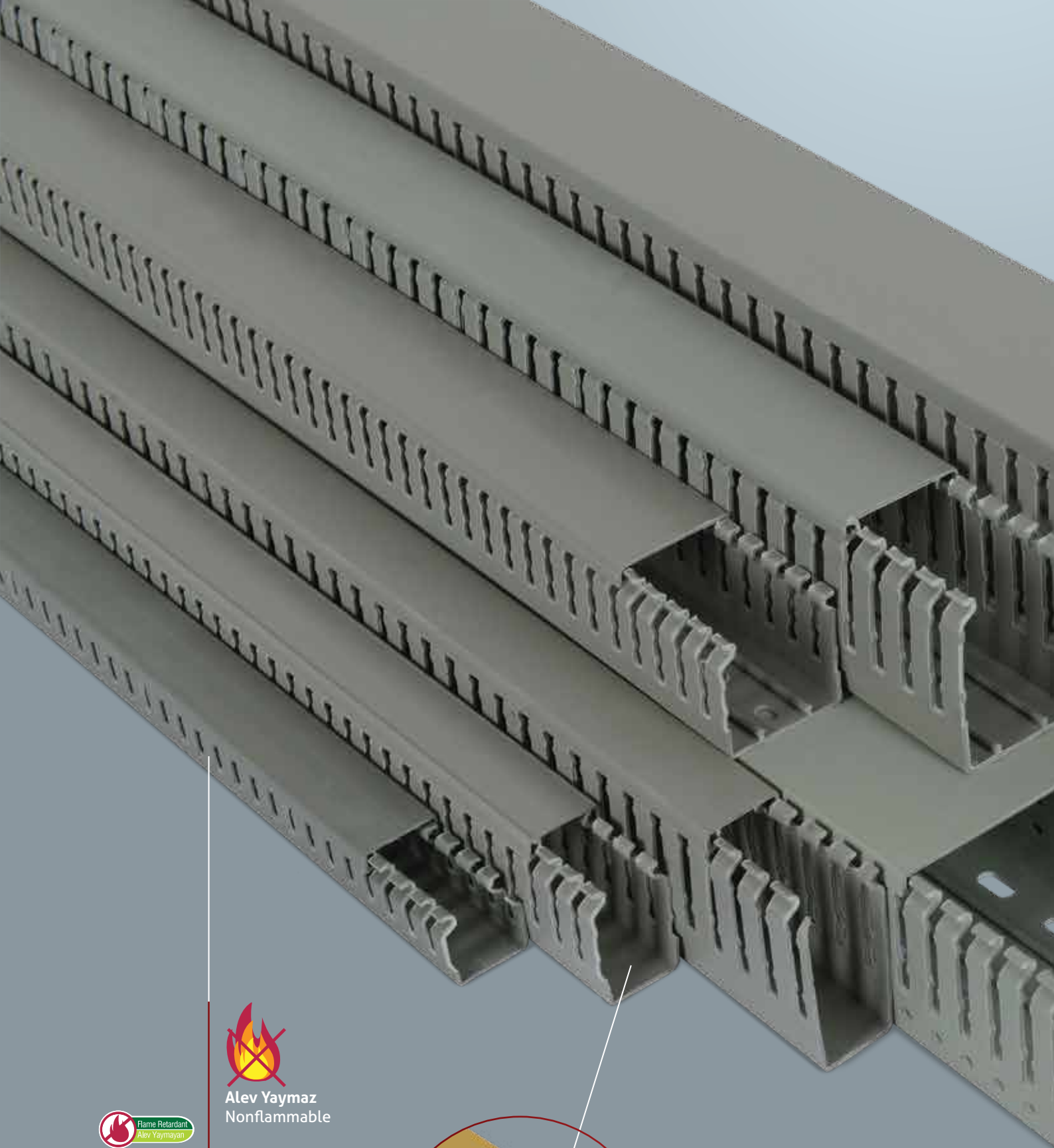

Alev Yaymaz
Nonflammable



Ürün Renkleri - Product Colors



Beyaz
White



Mavi
Blue



Gri
Grey

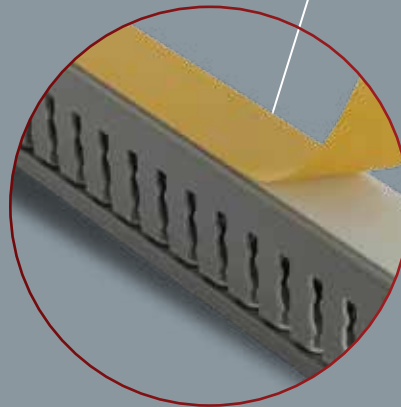

**Kolay yapışmayı sağlayan,
Çift taraflı bant kullanılabilir.**
Easy attached double sided adhesive
tape could be used



Pano tipi kablo kanallarımızın teknik özellikleri

Technical Specifications for our Slotted Cable Trunkings

Özel kapak dizaynı sayesinde kolay kapanma ve açılma, dikey pozisyonda dahi en iyi performans. Special design of cover provides easy closing and opening and show the best performance even in vertical position.

Alt kırılma noktası sayesinde yan keski vb. alet kullanarak kanal yan duvarının kolayca kırılarak hızlı montaj sağlanması. With the cutting point at the bottom easily breaking sides and installed on the wall without using any tool.

Üst kırılma noktası sayesinde herhangi bir el aletine ihtiyaç duymadan kanal yanlarında bulunan tırnakların kolayca kırılarak hızlı montaj sağlanması. The breaking points on the top provide easy breaking side nails and fast installation.

Tabanda bulunan raylar sayesinde kanal tutucu vb. aksesuarların kolayca montajı. The rails on the bottom helps to assembly holders and other accessories easily.



25 x 25

43,55 ₺

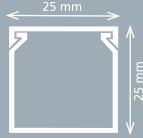

Ürün Kodu - Product Code

APSG-25025

Ambalaj Miktarı - Package total (m) 100 m

Ambalaj şekli - Package Kutu - Box

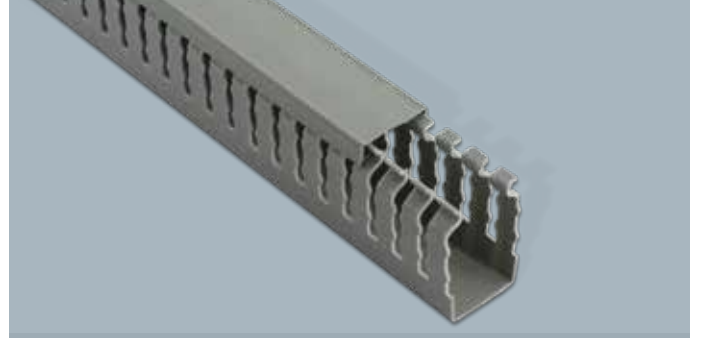

25 x 40

55,00 ₺

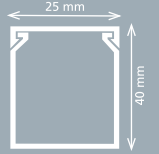

Ürün Kodu - Product Code

APSG-25040

Ambalaj Miktarı - Package total (m) 80 m

Ambalaj şekli - Package Kutu - Box

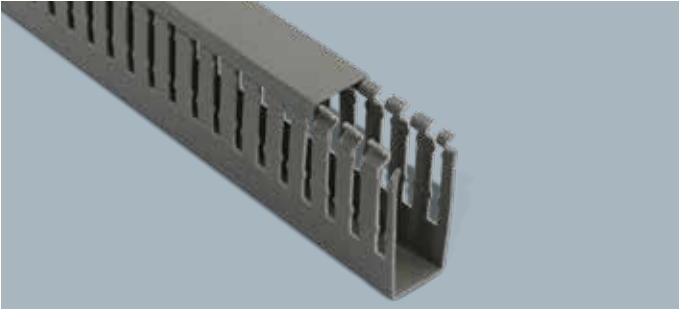

25 x 60

89,00 ₺

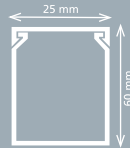

Ürün Kodu - Product Code

APSG-25060

Ambalaj Miktarı - Package total (m) 48 m

Ambalaj şekli - Package Kutu - Box

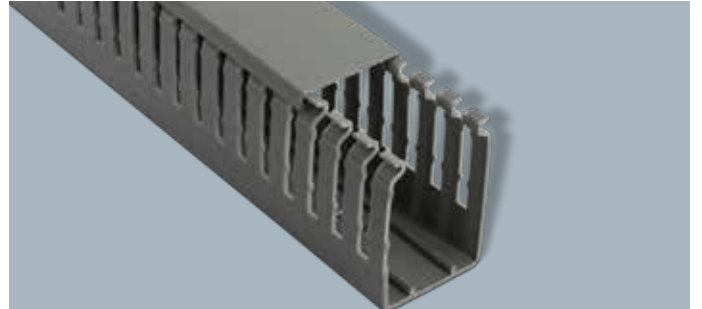

40 x 40

71,00 ₺

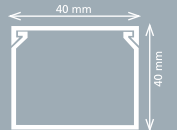

Ürün Kodu - Product Code

APSG-40040

Ambalaj Miktarı - Package total (m) 72 m

Ambalaj şekli - Package Kutu - Box

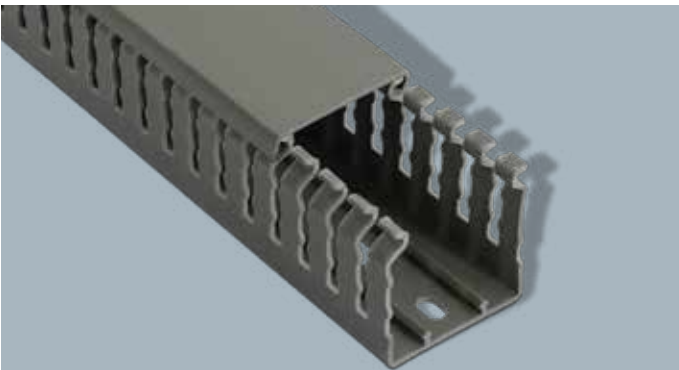

40 x 60

94,00 ₺

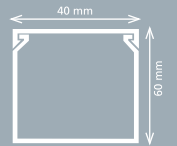

Ürün Kodu - Product Code

APSG-40060

Ambalaj Miktarı - Package total (m) 48 m

Ambalaj şekli - Package Kutu - Box

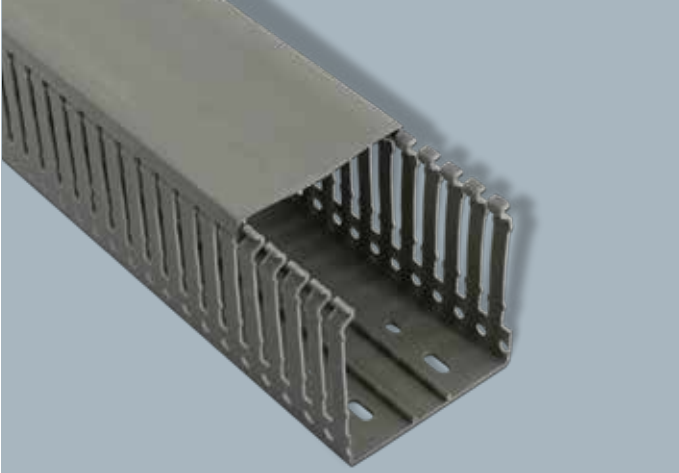
**60 x 60**

121,00 ₺

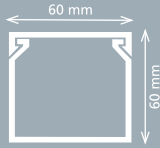

Ürün Kodu - Product Code

APSG-60060

Ambalaj Miktarı - Package total (m) 32 m

Ambalaj şekli - Package Kutu - Box

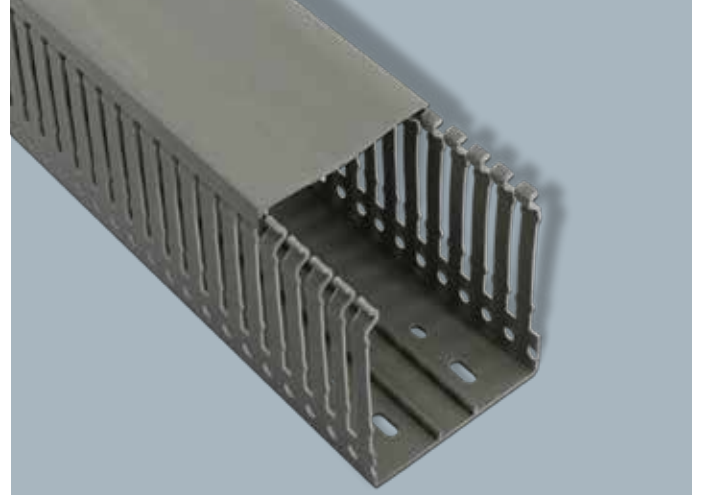
**60 x 80**

149,00 ₺

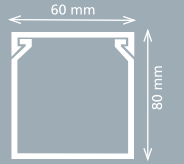

Ürün Kodu - Product Code

APSG-60080

Ambalaj Miktarı - Package total (m) 24 m

Ambalaj şekli - Package Kutu - Box

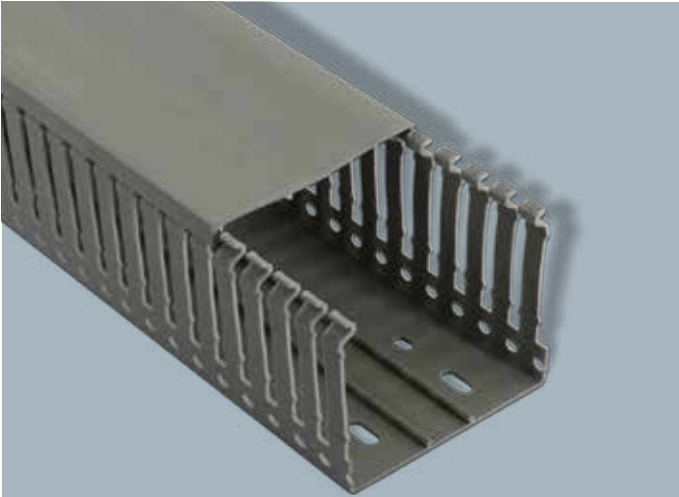
**80 x 60**

170,00 ₺

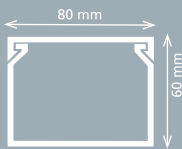

Ürün Kodu - Product Code

APSG-80060

Ambalaj Miktarı - Package total (m) 24 m

Ambalaj şekli - Package Kutu - Box

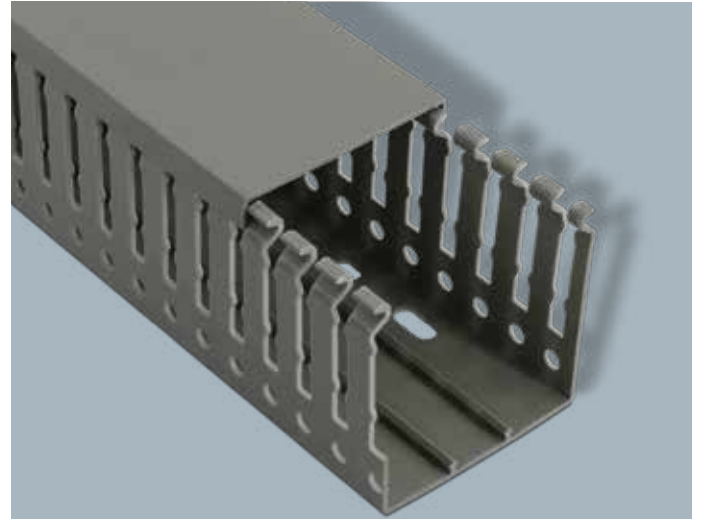
**80 x 80**

216,00 ₺

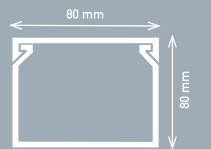

Ürün Kodu - Product Code

APSG-80080

Ambalaj Miktarı - Package total (m) 18 m

Ambalaj şekli - Package Kutu - Box

YENİ ÜRÜN
NEW PRODUCT



100'LÜK ASPIRATÖR - ASPIRATOR

Ürün Kodu - Product Code

AK - C100

Çalışma Akımı - Operation Voltage 220-240 V / 50-60 Hz

Emiş Hacmi - Airflow 100 m³/h

Devir Hızı - Round Speed 2250 rpm

Güç - Power 12W

Fiyat 375,00 ₺

Kutu - Box Pcs. : 20



YENİ ÜRÜN
NEW PRODUCT



120'LİK ASPIRATÖR - ASPIRATOR

Ürün Kodu - Product Code

AK - C120

Çalışma Akımı - Operation Voltage 220-240 V / 50-60 Hz

Emiş Hacmi - Airflow 120 m³/h

Devir Hızı - Round Speed 1900 rpm

Güç - Power 15W

Fiyat 395,00 ₺

Kutu - Box Pcs. : 20



YENİ ÜRÜN
NEW PRODUCT



150'LİK ASPIRATÖR - ASPIRATOR

Ürün Kodu - Product Code

AK - C150

Çalışma Akımı - Operation Voltage 220-240 V / 50-60 Hz

Emiş Hacmi - Airflow 150 m³/h

Devir Hızı - Round Speed 1800 rpm

Güç - Power 20W

Fiyat 545,00 ₺

Kutu - Box Pcs. : 20



ABS panolarımızın teknik özellikleri

Technical Specification of
ABS Panel Boards



IP65



IK Derecesi
IK Degree : IK08

FİYAT SORUNUZ

FİYAT SORUNUZ

Kilit Sistemi
Lock System

1 mm Galvanizli Çelik Montaj Plakası
1 mm Galvanized Steel Mounting Plate

YENİ ÜRÜN
NEW PRODUCT

YENİ ÜRÜN
NEW PRODUCT

YENİ ÜRÜN
NEW PRODUCT



ABS PC IP65 CE

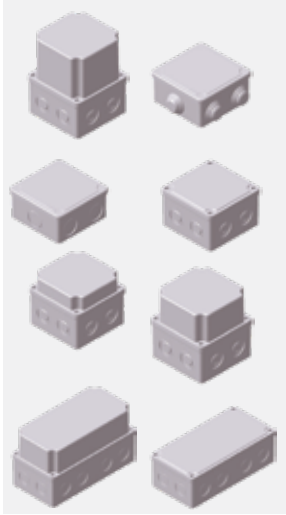

Kapaklı Buat - Thermoplastic Box

KOD CODE	ÜRÜN ÖLÇÜLERİ SIZE	ÜRÜN PRODUCT	SERTİFİKA	RENK COLOUR	KOLİ ADEDİ BOX PCS	FİYAT
A8585420-62	85 x 85 x 42	Sıva Üstü Kare Buat Thermoplastic Box	IP40	Gri-Grey	60	36.25 ₺
B858542	85 x 85 x 42	Sıva Üstü Kare Buat Vidalı Thermoplastic Box	IP40	Gri-Grey	60	37.90 ₺
A11011072-68	110 x 110 x 72	Sıva Üstü Kare Buat Thermoplastic Box	IP40	Gri-Grey	48	69.95 ₺
A11011097-68	110 x 110 x 97	Sıva Üstü Kare Buat Thermoplastic Box	IP65	Gri-Grey	48	76.00 ₺
A110110122-68	110 x 220 x 122	Sıva Üstü Kare Buat Thermoplastic Box	IP65	Gri-Grey	48	79.00 ₺
A110110147-68	110 x 110 x 147	Sıva Üstü Kare Buat Thermoplastic Box	IP65	Gri-Grey	48	85.00 ₺
A11022072-68	110 x 220 x 72	Sıva Üstü Kare Buat Thermoplastic Box	IP65	Gri-Grey	24	105.00 ₺

Perdeli Panolar

YENİ ÜRÜN
NEW PRODUCT



TEKNİK ÖZELLİKLER

Ham madde : ABS (Ral 7035 Gri) - Isı dayanıklı : -40°C / +80°C
Darbe dayanıklı
Standart tip panolar için 650°C kızaaran tel deneyi
HF yanmaz panolar için 960°C kızaaran tel deneyi
Paslanmaz çelik vidalı kapak - Taban sacı - Kilit sistemi
Montaj rayı ve klemens takmaya müsait gövde tasarımı
Alçak gerilim şalt ekipmanları montaja müsait yapı

TECHNICAL SPECIFICATIONS

Material : ABS (Ral 7035 Gri) - Health Strangth : -40°C / +80°C
Impact resitant
650°C glow wire test for standart type
960°C glow wire test for HF type
Stainless stell screws for cover - Steinnless temm base plate
Lock system - Design provided installation for DIN rails and terminals
Suitable to assembly low vottage swichtchgear equipment



IP65

ABS PC IP65 CE

ABS Perdeli Opak Pano

KOD-CODE	ÜRÜN ÖLÇÜLERİ -SIZE	ÖLÇÜ -SIZE	KOLİ ADEDİ-BOX PCS	FİYAT
AKABP-250150	25x35x15	2x8 = 18 Otomat	1	1.087,00 ₺
AKABP-300400	30x40x17	2x12 = 24 Otomat	1	1.470,00 ₺
AKABP-350500	35x50x19	3x14 = 42 Otomat	1	1.965,00 ₺
AKABP-400200	40x60x20	4x17 = 68 Otomat	1	2.580,00 ₺

ABS Perdeli Şeffaf Pano

KOD-CODE	ÜRÜN ÖLÇÜLERİ -SIZE	ÖLÇÜ -SIZE	KOLİ ADEDİ-BOX PCS	FİYAT
AKAPCP-250150	25x35x15	2x8 = 18 Otomat	1	1.200,00 ₺
AKAPCP-300400	30x40x17	2x12 = 24 Otomat	1	1.580,00 ₺
AKAPCP-350500	35x50x19	3x14 = 42 Otomat	1	2.400,00 ₺
AKAPCP-400200	40x60x20	4x17 = 68 Otomat	1	3.100,00 ₺

ABS Pano - ABS Board



TEKNİK ÖZELLİKLER

Hammadde : ABS (Ral 7035 Gri)
 Isı dayanıklı : -40°C / +80°C
 Darbe dayanıklı
 Standart tip panolar için 650°C kızaran tel deneyi
 HF yanmaz panolar için 960°C kızaran tel deneyi
 Paslanmaz çelik vidalı kapak
 Taban sacı
 Kilit sistemi
 Montaj rayı ve klemens takmaya müsait gövde tasarımı
 Alçak gerilim şalt ekipmanları montaja müsait yapı

TECHNICAL SPECIFICATIONS

Material : ABS (Ral 7035 Gri)
 Health Strangth : -40°C / +80°C
 Impact resitant
 650°C glow wire test for standart type
 960°C glow wire test for HF type
 Stainless stell screws for cover
 Stainless temm base plate
 Lock system
 Design provided installation for DIN rails and terminals
 Suitable to assembly low voltage swichtchgear equipment



IP65

KOD CODE	ÜRÜN ÖLÇÜLERİ SIZE	KOLİ ADEDİ BOX PCS	FİYAT
AKAB - 200130	200x300x130	1	560,00 ₺
AKAB - 250150	250x350x150	1	770,00 ₺
AKAB - 300400	300x400x170	1	940,00 ₺
AKAB - 300220	300x400x220	1	1.115,00 ₺
AKAB - 350190	350x500x190	1	1,395,00 ₺
AKAB - 400180	400x500x180	1	1.465,00 ₺
AKAB - 400240	400x500x240	1	1.720,00 ₺
AKAB - 400200	400x600x200	1	1.790,00 ₺
AKAB - 500230	500x600x230	1	2.700,00 ₺
AKAB - 500250	500x700x250	1	3.040,00 ₺
AKAB - 600800	600x800x280	1	

ABS IP65 CE

PC Şeffaf Kapaklı Panolar - Panel Boards With Pc Transparent Door



TEKNİK ÖZELLİKLER

Hammadde : ABS (Ral 7035 Gri)
Isı dayanıklı : -40°C / +80°C
Darbe dayanıklı
Standart tip panolar için 650°C kızaran tel deneyi
HF yanmaz panolar için 960°C kızaran tel deneyi
Paslanmaz çelik vidalı kapak
Taban sacı
Kilit sistemi
Montaj rayı ve klemens takmaya müsait gövde tasarımı
Alçak gerilim şalt ekipmanları montaja müsait yapı

TECHNICAL SPECIFICATIONS

Material : ABS (Ral 7035 Gri)
Health Strangth : -40°C / +80°C
Impact resitant
650°C glow wire test for standart type
960°C glow wire test for HF type
Steinless stell screws for cover
Steinless temberg base plate
Lock system
Design provided installation for DIN rails and terminals
Suitable to assembly low voltage switcthgear equipment



KOD CODE	ÜRÜN ÖLÇÜLERİ SIZE	KOLİ ADEDİ BOX PCS	FİYAT
AKPC - 200130	200x300x130	1	600,00 ₺
AKPC - 250150	250x350x150	1	840,00 ₺
AKPC - 300400	300x400x170	1	995,00 ₺
AKPC - 300220	300x400x220	1	1.150,00 ₺
AKPC - 350190	350x500x190	1	1.505,00 ₺
AKPC - 400180	400x500x180	1	1.620,00 ₺
AKPC - 400240	400x500x240	1	1.950,00 ₺
AKPC - 400200	400x600x200	1	1.995,00 ₺
AKPC - 500230	500x600x230	1	3.156,00 ₺
AKPC - 500250	500x700x250	1	3.578,00 ₺
AKPC - 600800	600x800x280	1	☎

ABS PC IP65 CE



Plastik Susta (Takviyeli) - Plastic Strina (Consolidated)

KOD CODE	ÜRÜN ÖLÇÜLERİ SIZE	KOLİ ADEDİ BOX PCS	FİYAT
APP10005	5 mt plastik susta - 5 mt plastic strina consolidated	60	3,50 \$
APP10010	10 mt plastik susta - 10 mt plastic strina consolidated	50	4,60 \$
APP10015	15 mt plastik susta - 15 mt plastic strina consolidated	40	6,90 \$
APP10020	20 mt plastik susta - 20 mt plastic strina consolidated	30	9,20 \$
APP10025	25 mt plastik susta - 25 mt plastic strina consolidated	25	1.140 \$
APP10030	30 mt plastik susta - 30 mt plastic strina consolidated	20	13,65 \$



Çelik Susta - Steel Strina

KOD CODE	ÜRÜN ÖLÇÜLERİ SIZE	KOLİ ADEDİ BOX PCS	FİYAT
APC10005	5 mt çelik susta - 5 mt steel strina	50	4,45 \$
APC10010	10 mt çelik susta - 10 mt steel strina	40	6,95 \$
APC10015	15 mt çelik susta - 15 mt steel strina	30	10,15 \$
APC10020	20 mt çelik susta - 20 mt steel strina	20	13,30 \$
APC10025	25 mt çelik susta - 25 mt steel strina	15	15,80 \$
APC10030	30 mt çelik susta - 30 mt steel strina	10	18,95 \$



Çelik Susta (Takviyeli) - Steel Strina (Consolidated)

KOD CODE	ÜRÜN ÖLÇÜLERİ SIZE	KOLİ ADEDİ BOX PCS	FİYAT
APT10005	5 mt çelik susta - 5 mt steel strina consolidated	60	6,32 \$
APT10010	10 mt çelik susta - 10 mt steel strina consolidated	50	8,85 \$
APT10015	15 mt çelik susta - 15 mt steel strina consolidated	40	13,30 \$
APT10020	20 mt çelik susta - 20 mt steel strina consolidated	30	17,70 \$
APT10025	25 mt çelik susta - 25 mt steel strina consolidated	25	22,15 \$
APT10030	30 mt çelik susta - 30 mt steel strina consolidated	20	26,55 \$

YENİ ÜRÜN
NEW PRODUCT

CCA KABLO



MAKARALI UZATMA KABLOSU - ROLLER EXTENSION CABLE

KOD CODE	KESİT SIZE	ÜRÜN PRODUCT	KESİT SECTION	KOLİ İÇİ CTN - PCS	FİYAT
AK 300	Boş Makara	Makaralı Uzatma Kablosu	Boş / Spool Empty	4	490,00 ₺
AK 315-20	20 MT	Makaralı Uzatma Kablosu	3 x 1,5 mm ²	4	☎
AK 315-35	35 MT	Makaralı Uzatma Kablosu	3 x 1,5 mm ²	4	☎
AK 315-50	50 MT	Makaralı Uzatma Kablosu	3 x 1,5 mm ²	4	☎
AK 325-20	20 MT	Makaralı Uzatma Kablosu	3 x 2,5 mm ²	4	☎
AK 325-30	30 MT	Makaralı Uzatma Kablosu	3 x 2,5 mm ²	4	☎
AK 325-40	40 MT	Makaralı Uzatma Kablosu	3 x 2,5 mm ²	4	☎
AK 325-50	50 MT	Makaralı Uzatma Kablosu	3 x 2,5 mm ²	4	☎

Tesisat Grubu

Installation
Group

Çelik
Steel

Golvaniz
Galvanized

Plastik Sprial
plastic Sprial

Kılavuz Telli
With Guide Wire

PVC Düz Boru 3m PVC Rigid Conduit Hafif Seri / Light Gauge



Alev Yayımayan
Yayla Bükülebilir

Self Extinguishing
Malleable Rigid Conduit

Ürün Renkleri - Product Colors



Gri
Grey

Siyah
Black

KOD CODE	DIŞ ÇAP (MM) EX. DIAMETER (MM)	İÇ ÇAP (MM) INT. DIAMETER (MM)	AMBALAJ PACKAGING	FİYAT	MUFLU FİYAT
AK 10121	Ø 16	14,5	102 m	16,50 ₺	20.50 ₺
AK 10122	Ø 20	17,5	102 m	24,00 ₺	28.00 ₺
AK 10123	Ø 25	22,1	51 m	32,00 ₺	37.50 ₺
AK 10124	Ø 32	29,2	45 m	53,00 ₺	61.50 ₺

 **320 Newton**

TEKNİK ÖZELLİKLER		TECHNICAL SPECIFICATIONS	
Standart	: EN 61386-21 / 22	Standart	: En 61386-21 / 22
Malzeme	: PVC Bazlı Termoplastik	Material	: PVC Based Thermoplastic
Sıkıştırma Dayanımı	: 320 Newton / 60 sn./sec / 23 +2°C	Compression Resistance	: 320 Newton / 60 sn./sec / 23 +2°C
Darbe Dayanımı	: 1 kg. / 100 mm / -25°C	Impact Resistance	: 1 kg. / 100 mm / -25°C
Çalışma Ortamı Sıcaklığı	: -25°C + 60°C	Working Temperature	: -25°C + 60°C
Yalıtım Gerilimi	: 2000 V./50 H. / 15 dak.	Insulating Strength	: 2000 V./50 Hz. / 15 min.
Kendiliğinden Sönen PVC Malzeme	: UL94 V0	PVC Material (Self Extinguishing)	: UL94 V0
Boru Boyu	: 3 m	Conduit Length	: 3 m



PP SİRİRAL BORU REKORU (RECORD)

ANMA ÇAPI	Ø 16	Ø 20	Ø 25	Ø 32
AMBALAJ - PCS.	100	100	100	100
KOD - CODE	AKK - 16 - PP	AKR - 20 - PP	AKR - 25 - PP	AKR - 32 - PP
FİYAT	20,50 ₺	22,00 ₺	2390 ₺	31,00 ₺



PP DİRSEK - ELBOW

ANMA ÇAPI	Ø 16	Ø 20	Ø 25	Ø 32
AMBALAJ - PCS.	100	100	100	100
KOD - CODE	AKD - 16 - PP	AKD - 20 - PP	AKD - 25 - PP	AKD - 32 - PP
FİYAT	11,50 ₺	14,75 ₺	18,75 ₺	26,80 ₺



PP AÇILIR DİRSEK - ELBOW OPENS

ANMA ÇAPI	Ø 16	Ø 20	Ø 25	Ø 32
AMBALAJ - PCS.	25	25	25	15
KOD - CODE	AKA - 16 - PP	AKA - 20 - PP	AKA - 25 - PP	AKA - 32 - PP
FİYAT	32,36 ₺	43,15 ₺	53,95 ₺	62,94 ₺



PP T BAĞLANTI - T LINK

ANMA ÇAPI	Ø 16	Ø 20	Ø 25	Ø 32
AMBALAJ - PCS.	100	100	100	100
KOD - CODE	AKT - 16 - PP	AKT - 20 - PP	AKT - 25 - PVC	AKT - 32 - PP
FİYAT	16,18 ₺	19,78 ₺	25,95 ₺	32,36 ₺

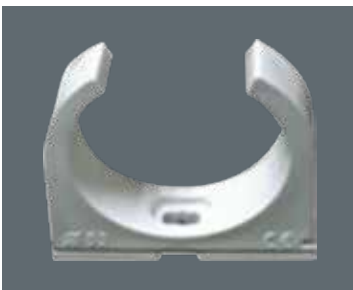

AY KROŞE - MOON CROCHET

ANMA ÇAPI	Ø 16	Ø 20	Ø 25	Ø 32
AMBALAJ - PCS.	50	50	50	25
KOD - CODE	AKS - 16 - PP	AKS - 25 - PP	AKS - 25 - PP	AKS - 32 - PP
FİYAT	7,50 ₺	9,25 ₺	10,95 ₺	14,75 ₺

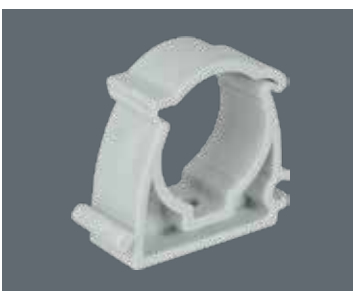

KAPAKLI KROŞE - CAPPED MOON

ANMA ÇAPI	Ø 16	Ø 20	Ø 25	Ø 32
AMBALAJ - PCS.	100	100	100	100
KOD - CODE	AKK - 16 - PP	AKK - 20 - PP	AKK - 25 - PP	AKK - 32 - PP
FİYAT	4,50 ₺	4,95 ₺	5,35 ₺	6,00 ₺

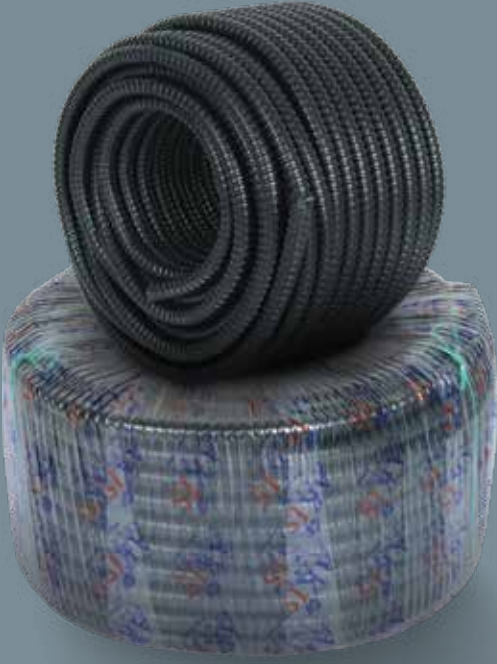

PVC İZOLELİ ÇELİK SİRAL BORU

PVC INSULATED STEEL SPIRAL CONDUIT

KOD CODE	ÜRÜN ADI PRODUCT NAME	MT. PACK	FİYAT
APS - ICS 9	9 mm İzoleli Çelik Spiral Boru 9 mm Insulated Steel Spirals	50	17,50 ₺
APS - ICS 11	11 mm İzoleli Çelik Spiral Boru 11 mm Insulated Steel Spirals	50	19,10 ₺
APS - ICS 14	14 mm İzoleli Çelik Spiral Boru 14 mm Insulated Steel Spirals	50	23,30 ₺
APS - ICS 16	16 mm İzoleli Çelik Spiral Boru 16 mm Insulated Steel Spirals	50	24,95 ₺
APS - ICS 18	18 mm İzoleli Çelik Spiral Boru 18 mm Insulated Steel Spirals	50	28,80 ₺
APS - ICS 21	21 mm İzoleli Çelik Spiral Boru 21 mm Insulated Steel Spirals	50	34,50 ₺
APS - ICS 26	26 mm İzoleli Çelik Spiral Boru 26 mm Insulated Steel Spirals	25	42,75 ₺
APS - ICS 29	29 mm İzoleli Çelik Spiral Boru 29 mm Insulated Steel Spirals	25	46,25 ₺
APS - ICS 32	32 mm İzoleli Çelik Spiral Boru 32 mm Insulated Steel Spirals	25	52,10 ₺
APS - ICS 37	37 mm İzoleli Çelik Spiral Boru 37 mm Insulated Steel Spirals	25	66,85 ₺
APS - ICS 40	40 mm İzoleli Çelik Spiral Boru 40 mm Insulated Steel Spirals	25	74,34 ₺
APS - ICS 42	42 mm İzoleli Çelik Spiral Boru 42 mm Insulated Steel Spirals	25	76,92 ₺
APS - ICS 45	45 mm İzoleli Çelik Spiral Boru 45 mm Insulated Steel Spirals	25	93,30 ₺
APS - ICS 50	50 mm İzoleli Çelik Spiral Boru 50 mm Insulated Steel Spirals	25	104,00 ₺

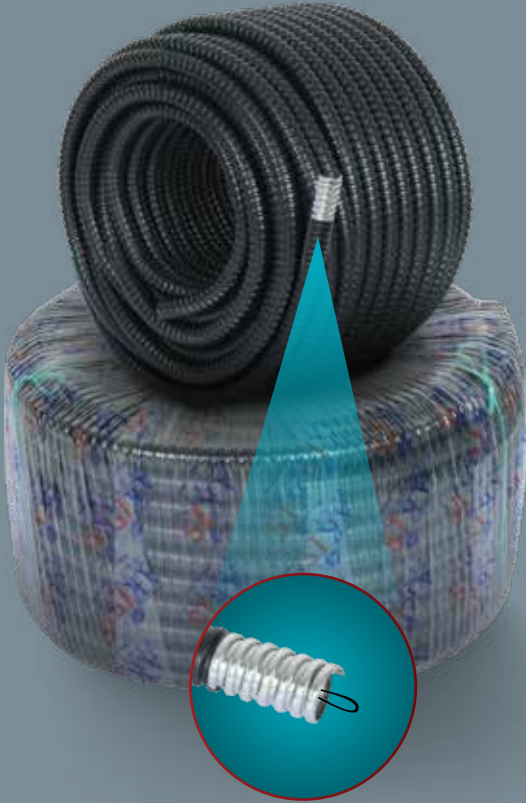

KILAVUZ TELLİ İZOLELİ ÇELİK SİRAL BORU

PVC INSULATED STEEL SPIRAL CONDUIT WITH GUIDE

KOD CODE	ÜRÜN ADI PRODUCT NAME	MT. PACK	FİYAT
APS - ICST 9	9 mm İzoleli Çelik Spiral Boru Telli 9 mm Insulated Steel Spirals Conduit With Guide	50	18,65 ₺
APS - ICST 11	11 mm İzoleli Çelik Spiral Boru Telli 11 mm Insulated Steel Spirals Conduit With Guide	50	21,75 ₺
APS - ICST 14	14 mm İzoleli Çelik Spiral Boru Telli 14 mm Insulated Steel Spirals Conduit With Guide	50	25,50 ₺
APS - ICST 16	16 mm İzoleli Çelik Spiral Boru Telli 16 mm Insulated Steel Spirals Conduit With Guide	50	27,60 ₺
APS - ICST 18	18 mm İzoleli Çelik Spiral Boru Telli 18 mm Insulated Steel Spirals Conduit With Guide	50	31,10 ₺
APS - ICST 21	21 mm İzoleli Çelik Spiral Boru Telli 21 mm Insulated Steel Spirals Conduit With Guide	50	37,00 ₺
APS - ICST 26	26 mm İzoleli Çelik Spiral Boru Telli 26 mm Insulated Steel Spirals Conduit With Guide	25	45,85 ₺
APS - ICST 29	29 mm İzoleli Çelik Spiral Boru Telli 29 mm Insulated Steel Spirals Conduit With Guide	25	49,75 ₺
APS - ICST 32	32 mm İzoleli Çelik Spiral Boru Telli 32 mm Insulated Steel Spirals Conduit With Guide	25	56,75 ₺
APS - ICST 37	37 mm İzoleli Çelik Spiral Boru Telli 37 mm Insulated Steel Spirals Conduit With Guide	25	72,25 ₺
APS - ICST 40	40 mm İzoleli Çelik Spiral Boru Telli 40 mm Insulated Steel Spirals Conduit With Guide	25	78,60 ₺
APS - ICST 42	42 mm İzoleli Çelik Spiral Boru Telli 42 mm Insulated Steel Spirals Conduit With Guide	25	83,90 ₺
APS - ICST 45	45 mm İzoleli Çelik Spiral Boru Telli 45 mm Insulated Steel Spirals Conduit With Guide	25	88,90 ₺
APS - ICST 50	50 mm İzoleli Çelik Spiral Boru Telli 50 mm Insulated Steel Spirals Conduit With Guide	25	116,55 ₺



ÇELİK SİRALLI BORU STEEL SPIRAL CONDUITS

KOD CODE	ÜRÜN ADI PRODUCT NAME	MT. PACK	FİYAT
APS - CS 9	9 mm Çelik Spiral Boru 9 mm Steel Spirals	50	13,20 ₺
APS - CS 11	11 mm Çelik Spiral Boru 11 mm Steel Spirals	50	14,00 ₺
APS - CS 14	14 mm Çelik Spiral Boru 14 mm Steel Spirals	50	17,00 ₺
APS - CS 16	16 mm Çelik Spiral Boru 16 mm Steel Spirals	50	18,50 ₺
APS - CS 18	18 mm Çelik Spiral Boru 18 mm Steel Spirals	50	20,50 ₺
APS - CS 21	21 mm Çelik Spiral Boru 21 mm Steel Spirals	50	23,30 ₺
APS - CS 26	26 mm Çelik Spiral Boru 26 mm Steel Spirals	25	32,65 ₺
APS - CS 29	29 mm Çelik Spiral Boru 29 mm Steel Spirals	25	34,75 ₺
APS - CS 32	32 mm Çelik Spiral Boru 32 mm Steel Spirals	25	36,52 ₺
APS - CS 37	37 mm Çelik Spiral Boru 37 mm Steel Spirals	25	48,37 ₺
APS - CS 40	40 mm Çelik Spiral Boru 40 mm Steel Spirals	25	56,25 ₺
APS - CS 42	42 mm Çelik Spiral Boru 42 mm Steel Spirals	25	58,75 ₺
APS - CS 45	45 mm Çelik Spiral Boru 45 mm Steel Spirals	25	68,75 ₺
APS - CS 50	50 mm Çelik Spiral Boru 50 mm Steel Spirals	25	78,25 ₺

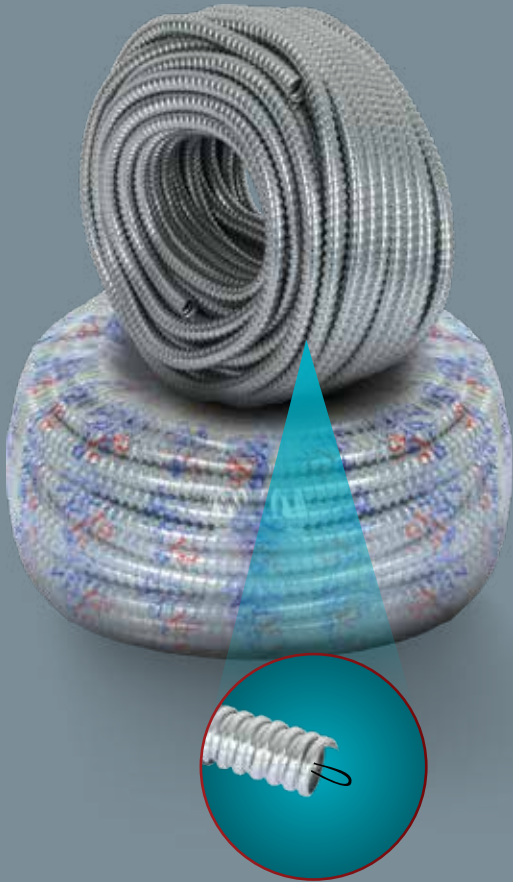

KILAVUZ TELLİ ÇELİK SİRALLI BORU STEEL SPIRAL CONDUITS WITH GUIDE

KOD CODE	ÜRÜN ADI PRODUCT NAME	MT. PACK	FİYAT
APS - CST 9	9 mm Çelik Spiral Boru Telli 9 mm Steel Spirals Conduit With Guide	50	16,25 ₺
APS - CST 11	11 mm Çelik Spiral Boru Telli 11 mm Steel Spirals Conduit With Guide	50	19,75 ₺
APS - CST 14	14 mm Çelik Spiral Boru Telli 14 mm Steel Spirals Conduit With Guide	50	20,25 ₺
APS - CST 16	16 mm Çelik Spiral Boru Telli 16 mm Steel Spirals Conduit With Guide	50	21,75 ₺
APS - CST 18	18 mm Çelik Spiral Boru Telli 18 mm Steel Spirals Conduit With Guide	50	26,25 ₺
APS - CST 21	21 mm Çelik Spiral Boru Telli 21 mm Steel Spirals Conduit With Guide	50	27,35 ₺
APS - CST 26	26 mm Çelik Spiral Boru Telli 26 mm Steel Spirals Conduit With Guide	25	34,65 ₺
APS - CST 29	29 mm Çelik Spiral Boru Telli 29 mm Steel Spirals Conduit With Guide	25	37,45 ₺
APS - CST 32	32 mm Çelik Spiral Boru Telli 32 mm Steel Spirals Conduit With Guide	25	43,55 ₺
APS - CST 37	37 mm Çelik Spiral Boru Telli 37 mm Steel Spirals Conduit With Guide	25	53,75 ₺
APS - CST 40	40 mm Çelik Spiral Boru Telli 40 mm Steel Spirals Conduit With Guide	25	55,00 ₺
APS - CST 42	42 mm Çelik Spiral Boru Telli 42 mm Steel Spirals Conduit With Guide	25	65,50 ₺
APS - CST 45	45 mm Çelik Spiral Boru Telli 45 mm Steel Spirals Conduit With Guide	25	72,50 ₺
APS - CST 50	50 mm Çelik Spiral Boru Telli 50 mm Steel Spirals Conduit With Guide	25	85,50 ₺

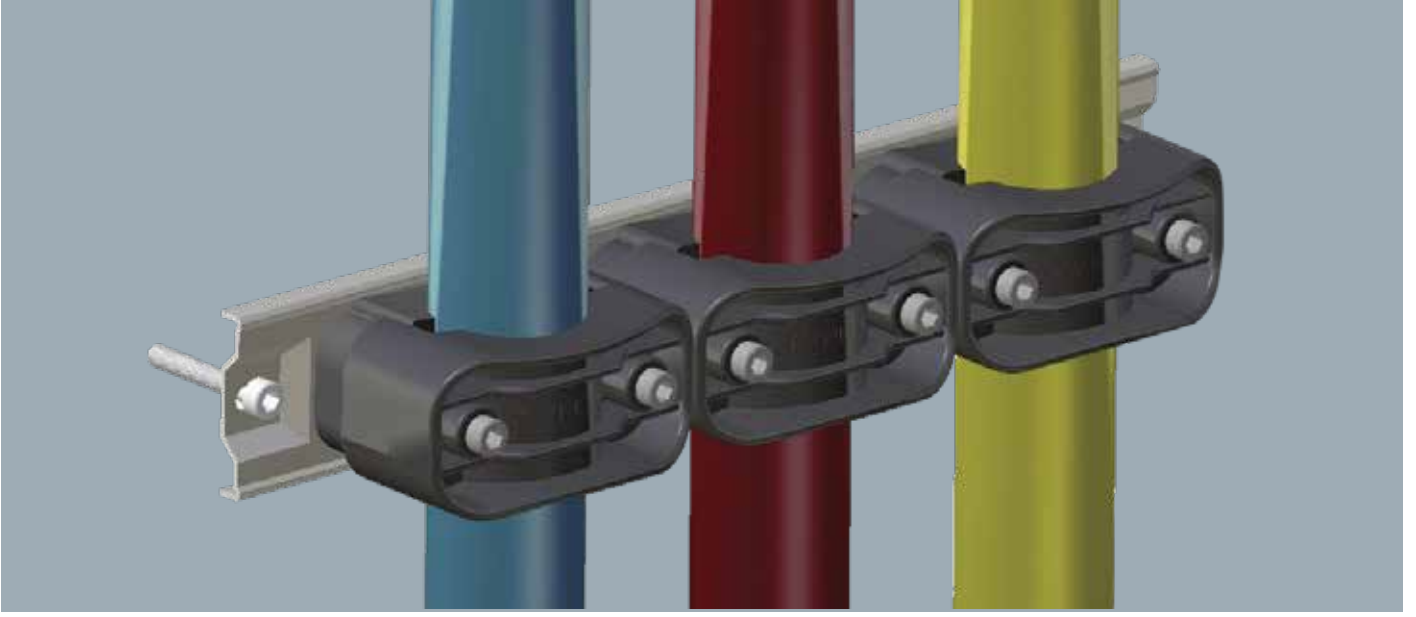

KABLO KELEPÇESİ - CABLE CLAMP

KOD CODE	ÜRÜN ADI PRODUCT NAME	KABLO ÇAP CABLE DIAMETER	KOLİ AĞIRLIĞI PARCEL HEIGHT	PAKET ADET BOX PCS	FİYAT
TYPE-301	TİP 1 XLPE Kablo Kelepçesi Cable Clamp	30 mm - 42 mm	16	150	46,00 ₺
TYPE-302	TİP 2 XLPE Kablo Kelepçesi Cable Clamp	36 mm - 50 mm	17	100	63,00 ₺
TYPE-303	TİP 3 XLPE Kablo Kelepçesi Cable Clamp	52 mm - 72 mm	16	50	91,00 ₺

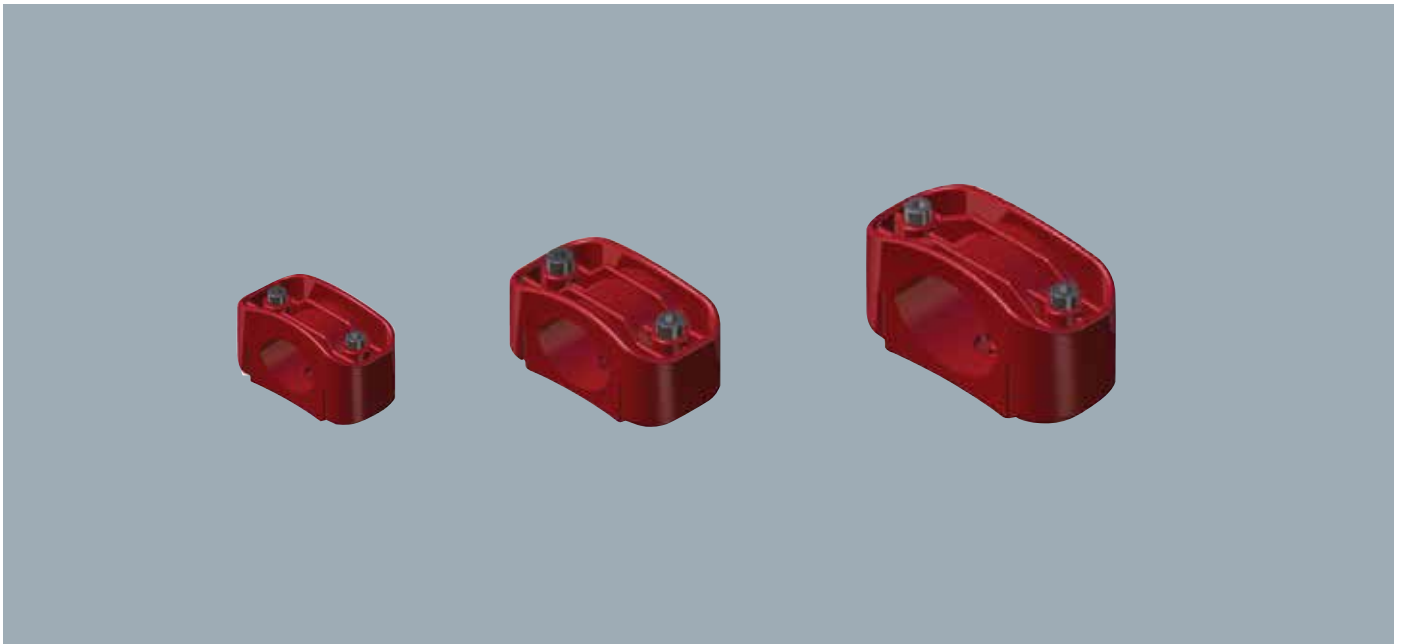



Numara / No : 2022/02203
TSE 19 99 11

BELGE KAPSAMI (130124-TSE-02022-holu belge devamı) : AK İŞ PLASTİK PROFİL ELEKTRİK SANAYİ VE TİCARET LİMİTED ŞİRKETİ
İLGİLİ TÜRK STANDARLARI/RELATED TURKISH STANDARD: TS EN 50369-2-1 : 19 96 2701

EN ÜNİVERSİYEL ÜYÜŞÜ ANA SICAKLIK BEYANI : +90 °C
ALEV YAYILMASINA KARŞI DAYANIKLILIK : ALEV YAYIMAYAN,
ELEKTRİKSEL SÜRÜKLÜK ÖZELLİĞİNE GÖRE UYGULANMAZ,
ELEKTRİKSEL YALITIM ÖZELLİĞİNE GÖRE UYGULANMAZ
EN 50369 : 1991'E GÖRE MAHAFAZA TARAFINDAN SAĞLANAN KORUMA DÜZEĞİNE GÖRE UYGULANMAZ
KORUZU VEYA KIRILTIYI MADDELERE KARŞI KORUMA İÇİ TARAFI VE DİŞİ TARAFI DÜŞÜK KÖRÜMALİ
5 STE M ER-5 M KAPADININ GÜVENLİLİĞİNİ SAĞLAMAYA GÖRE UYGULANMAZ,
ELEKTRİKSEL OLARAK KORULUCU AYIRIMAYA GÖRE UYGULANMAZ
AKAGLANAN TEŞİS KÖRÜMLERİNİN GÖRE KAPADIN ÜNİVERSİYEL ÜYÜŞÜ İÇİN DÜŞÜK VEYA YALITIM ÖZELLİĞİNE GÖRE UYGULANMAZ

Belge No : 2022/02203
07.02.2022

Belgeleme Merkezi Başkanı Adına
AHMET NURSU KARTAL

TSE İSTANBUL BELGELENDİRME MÜDÜRÜ

Belgeleme Merkezi Başkanı Adına
AHMET NURSU KARTAL
Belgeleme Merkezi Başkanı Adına
AHMET NURSU KARTAL



http://www.tse.gov.tr/eng/Belgeleme/BelgelemeBelgesi.aspx?belgeNo=202202203

TEST REPORT IEC 60335-1 HOUSEHOLD AND SIMILAR ELECTRICAL APPLIANCES – SAFETY – Part 1: General requirements	
Report Number.....	TR_2022198_1
Date of Issue.....	2022 March 29
Total number of pages.....	114
Applicant's name.....	EİK Sertifikasyon Uluslararası Belgeleme Gözetim Kontrol Denetim Hizmetleri A. Ş.
Address.....	Yenişehir Mah. Reyhan Cad. Tanay Konakları A-22 No: 30/22 İç Kapı No: 1 Pendik/İstanbul/Türkiye
Test specification:	
Standard.....	IEC 60335-1:2020
Test procedure.....	Test Report
Non-standard test method.....	N/A
Test Report Form No.....	IEC60335_12
Test Report Form(s) Originator.....	TÜV SÜD Product Service GmbH
Master TRF.....	Dated 2020-12-10
Test item description.....	Bathroom Ventilation Fan
Trade Mark.....	Ak İş Plastik Profil. Elek. San. Tic. Ltd. Şti
Manufacturer.....	Ak İş Plastik Profil. Elek. San. Tic. Ltd. Şti
Model/Type reference.....	See the page 5
Ratings.....	See the page 5
Testing location/ address.....	SGS Turkey E&E Laboratory / Bağlar Mah. Osmanpaşa Cad. No. 96 Is Istanbul Plaza E Giriş 34209 Güneşli Istanbul Turkey
Tested by (name + signature).....	Özer Gülmez
Approved by (name + signature).....	Mahmut Aksakallı



Disclaimer: This document is controlled and has been released electronically.
Only the version on the IEC60335 Website is the current document version



Numara / No : 2022/02203
TSE 19 99 11

BELGE KAPSAMI (130124-TSE-02022-holu belge devamı) : AK İŞ PLASTİK PROFİL ELEKTRİK SANAYİ VE TİCARET LİMİTED ŞİRKETİ
İLGİLİ TÜRK STANDARLARI/RELATED TURKISH STANDARD: TS EN 50369-2-1 : 19 96 2701

BELGE NUMARASI
REFERENCE NUMBER (OF LOG NO): 130124-TSE-02-02

BELGENİN İLK VERİLİŞ TARİHİ
DATE OF FIRST ISSUE OF LICENSE: 04 02 2022

BELGENİN SON GEÇERLİLİK TARİHİ
LICENSE VALID UNTIL: 04 02 2023

BELGE SAHİBİ KURULUŞUN ADI
NAME OF THE LICENSE HOLDER: AK İŞ PLASTİK PROFİL ELEKTRİK SANAYİ VE TİCARET LİMİTED ŞİRKETİ

BELGE SAHİBİ KURULUŞUN ADRESİ
ADDRESS OF THE LICENSE HOLDER: İZTELLİ ÖZAL CAD. NO:8 BAŞAKŞEHİR İSTANBUL/TÜRKİYE

ÜRETİM YERİ ADI
NAME OF THE MANUFACTURING PLACE: AK İŞ PLASTİK PROFİL ELEKTRİK SAN. VE TİC. LTD. ŞTİ

ÜRETİM YERİ ADRESİ
ADDRESS OF THE MANUFACTURING PLACE: İ.O.S.B.İSK. TÜRKSÜT ÖZAL CAD. ALT. NİTAÇ İŞ MERKEZİ NO: 8 / BLOK: 4/402 BAŞAKŞEHİR İTİS FANBUL İSTANBUL / TÜRKİYE

İPTAL EDİLEN BELGE NUMARASI (Var的话)
INVALID FORM OF SUPPLEMENTED LICENSE (If any):

TESCİLLİ TİCARİ MARKASI
REGISTERED TRADE MARK:

İLGİLİ TÜRK STANDARLARI
RELATED TURKISH STANDARDS: TS EN 50369-2-1 : 19 96 2701

Belge No : 2022/02203
07.02.2022

Belgeleme Merkezi Başkanı Adına
AHMET NURSU KARTAL

TSE İSTANBUL BELGELENDİRME MÜDÜRÜ

Belgeleme Merkezi Başkanı Adına
AHMET NURSU KARTAL
Belgeleme Merkezi Başkanı Adına
AHMET NURSU KARTAL



http://www.tse.gov.tr/eng/Belgeleme/BelgelemeBelgesi.aspx?belgeNo=202202203



Numara / No : 2022/02203
TSE 19 99 11

BELGE KAPSAMI (130124-TSE-02022-holu belge devamı) : AK İŞ PLASTİK PROFİL ELEKTRİK SANAYİ VE TİCARET LİMİTED ŞİRKETİ
İLGİLİ TÜRK STANDARLARI/RELATED TURKISH STANDARD: TS EN 50369-2-1 : 19 96 2701

(17x60 T BAĞLANTISI) L BAĞLANTISI İÇİ KOŞU: DİŞ KÖŞE SONLANDIRMA UCU
TEŞİS VE UYGULAMA İÇİN DARBEME KARŞI DAYANIKLILIK Z 2.

Diğer Özellikler
YALITIM TİPİ: METALİK OLMAYAN
SICAKLIK BEYANI: EN ÜNİVERSİYEL ÜYÜŞÜ ANA VE MAKUL SICAKLIK BEYANI : +70 °C
-EN DÜŞÜK TEŞİS VE UYGULAMA SICAKLIK BEYANI: +15 °C
-FN YÜZEK UYGULAMA SICAKLIK BEYANI: +60°C
ALEV YAYILMASINA KARŞI DAYANIKLILIK : ALEV YAYIMAYAN,
ELEKTRİKSEL SÜRÜKLÜK ÖZELLİĞİNE GÖRE UYGULANMAZ,
ELEKTRİKSEL YALITIM ÖZELLİĞİNE GÖRE UYGULANMAZ
KATI ÜZÜMLER VE SU GİRİŞİNE KARŞI KORUMA İP 40
KORUZU VEYA KIRILTIYI MADDELERE KARŞI KORUMA İÇİ VE DİŞİ TARAFI DÜŞÜK KÖRÜMALİ
5 STE M ER-5 M KAPADININ GÜVENLİLİĞİNİ SAĞLAMAYA GÖRE UYGULANMAZ,
ELEKTRİKSEL OLARAK KORULUCU AYIRIMAYA GÖRE DAKİLİ KORULUCU BÖLMESİ OLMAYAN
AKAGLANAN TEŞİS KÖRÜMLERİNİN GÖRE DUVARDA VE TAVARDA NÜVEYE MONTE EDİLEN VEYA YARI
SIVA ALTI
DÜŞÜMLERİN İSLATMA İŞLEMİ VE KENAR KONJUNDA TS-029 NİN MONTE EDİLMESİ DURUMUNDA
SIVALAR YALITIMLI KİLİTLENLER VE ENERJİ BİLGİLERİ ASASINDAKİ TEMASIN ÖNLENMESİNE GÖRE
REVAK EDİLMİŞ
TİPİ: T P 2
GDS'İN SIKIŞTIRMA DAYANIKLILIGINA GÖRE UYGULANMAZ

Belge No : 2022/02203
07.02.2022

Belgeleme Merkezi Başkanı Adına
AHMET NURSU KARTAL

TSE İSTANBUL BELGELENDİRME MÜDÜRÜ

Belgeleme Merkezi Başkanı Adına
AHMET NURSU KARTAL
Belgeleme Merkezi Başkanı Adına
AHMET NURSU KARTAL



http://www.tse.gov.tr/eng/Belgeleme/BelgelemeBelgesi.aspx?belgeNo=202202203

ELECTRICAL MATERIALS



AKIS

PLASTIC

Fabrika

İ.O.S.B. Eski Turgut Özal Cad.
Altıntaş İş Mrk. No:8 D Blok No:4/402
İkitelli - Başakşehir / İSTANBUL / TÜRKİYE

+90 212 671 44 71

+90 212 671 44 28

planlama@akisplastik.com.tr

export@akisplastik.com.tr

www.akisplastik.com.tr

Satış Müdürü

HAYATİ ATASEVEN

+90 531 991 66 02

Merkez (Satış Destek)

SEDA KURU

+90 535 206 28 66

İç Anadolu & Doğu Anadolu Bölgesi

CENGİZ ARDIÇ

Bölge Müdürü

+90 531 991 66 03

Akdeniz & Ege Bölgesi

HAKAN AKIN

Bölge Müdürü

+90 539 575 55 90